

# TM 11-5895-224-15

DEPARTMENT OF THE ARMY TECHNICAL MANUAL

---

**OPERATOR'S, ORGANIZATIONAL, FIELD  
AND DEPOT MAINTENANCE MANUAL**

**OPERATIONS CENTRAL AN/MSC-32**

This copy is a reprint which includes current pages from Changes 5 through 9.

---

*HEADQUARTERS, DEPARTMENT OF THE ARMY*

*15 MAY 1961*

## **WARNING**

### **HIGH VOLTAGE**

is used in  
this equipment.

### **DEATH ON CONTACT**

may result if safety precautions  
are not observed.

**EXTREMELY  
DANGEROUS POTENTIALS  
EXIST IN THE FOLLOWING UNITS:**

Power and signal entrance box	115 volts ac
Power distribution panel	115 volts ac
Teletypewriter TT-4 (*) /TG	115 volts ac
Reperforator-Transmitter,	115 volts dc
Teletypewriter TT-76 (*) /GGC	
Terminal, Telegraph TH-5/TG	560 volts dc
Intercommunication Station	270 volts dc
LS-147 (*) /FI	

## **WARNING**

### **VENTILATION IS ESSENTIAL**

To prevent asphyxiation, Operations Central AN/MS-32 must be ventilated at all times when occupied.

**DON'T TAKE CHANCES !**

CHANGE }  
No. 5 }

HEADQUARTERS  
DEPARTMENT OF THE ARMY  
WASHINGTON, D. C., 30 August 1967

**Organizational, DS, GS, and Depot Maintenance Manual**

**Including Repair Parts List**

**OPERATIONS CENTRAL AN/MS-32**

TM 11-5895-224-15, 15 May 1961, is changed as follows:  
Title is changed as shown above.

*Note.* The parenthetical reference to previous changes (example: "page 1 of C 3") indicates that pertinent material was published in that change.

*Page 3.* Add the following "Note" below the title of chapter 1:

*Note.* Shelters, Electrical Equipment S-184A/MS-32, S-184B/MS-32, S-184C/MS-32, and S-184D/MS-32 are similar to Shelter, Electrical Equipment S-184/MS-32. Information in this manual applies to all shelter facilities unless otherwise specified.

Paragraph 1 (page 1 of C 3). Delete paragraph 1.1 and substitute:

**1.1 Index of Publications**

Refer to the latest issue of DA Pam 310-4 to determine whether there are new editions, changes, or additional publications pertaining to the equipment.

*Page 3,* paragraph 2 (changed by C 4, 14 Jan 65). Delete paragraph 2 and substitute:

**2. Forms and Records**

*a. Reports of Maintenance and Unsatisfactory Equipment.* Use equipment forms and rec-

ords in accordance with instructions in TM 38-750.

*b. Report of Packaging and Handling Deficiencies.* Fill out and forward DD Form 6 (Report of Packaging and Handling Deficiencies) as prescribed in AR 700-58 (Army), NAVSUP Publication 378 (Navy), AFR 71-4 (Air Force), and MCO P4610-5 (Marine Corps).

*c. Discrepancy in Shipment Report (DISREP) (SF361).* Fill out and forward Discrepancy in Shipment Report (DISREP) (SF361) as prescribed in AR 55-38 (Army), NAVSUP Pub 459 (Navy), AFM 75-34 (Air Force), and MCO P4610.19 (Marine Corps).

*d. Reporting of Equipment Manual Improvements.* DA Form 2028 (Recommended Changes to DA Publications) will be used for reporting discrepancies and recommendations for improving this equipment publication. The form will be completed by the individual using the manual and forwarded direct to Commanding General, U.S. Army Electronics Command, ATTN: AMSEL-ME-NMP-AD, Fort Monmouth, N. J., 07703.

\*This change supersedes C 4, 14 January 1965, and TM 11-5895-224-25P, 5 January 1965.

Page 58, appendix I (changed by C 4, 14 Jan 65). Delete and substitute:

## APPENDIX I

### REFERENCES

The following references are applicable for the operator and repairman of Operations Central AN/MSC-82:

AR 310-1	Index of Administrative Publications.
AR 750-10	Maintenance of Supplies and Equipment Material Readiness (Serviceability of Unit Equipment).
DA Pam 310-4	Index of Technical Manuals, Technical Bulletins, Supply Manuals (Types 7, 8, and 9), Supply Bulletins, and Lubrication Orders.
DA Pam 310-7	Modification Work Orders.
MWO 11-5815-282-30/1	Modification of Teletypewriter Reperforator Transmitter TT-76/GGC, TT-76A/GGC, TT-76B/GGC, TT-178/FG, TT-178A/FG, TT-179/FG, TT-179A/FG, and TT-181/FG to Permit External Control of the Clutch Magnet of Communication Security Equipment.
SB 11-6	Dry Battery Supply Data.
SB 11-513	Multimeter AN/URM-105.
SB 11-540	Multimeter AN/URM-105 and TS-352/U.
TB SIG 354	Maintenance and Repair Procedures for Lightweight Field and Mobile Shelters of Aluminum Stressed Skin Foam-Core Construction (Covering S-141/G and S-144/G Type Shelters).
TM 9-213	Painting Instructions for Field Use.
TM 11-5410-206-12P	Operator and Organizational Maintenance Repair Parts and Special Tools List and Maintenance Allocation Chart: Shelter, Electrical Equipment S-141/G.
TM 11-5805-201-12	Organizational Maintenance Manual: Telephone Set TA-312/PT.
TM 11-5805-201-20P	Organizational Maintenance Repair Parts and Special Tool Lists: Telephone Set TA-312/PT.
TM 5805-201-35P	Field and Depot Maintenance Repair Parts and Special Tool Lists: Telephone Set TA-312/PT.
TM 11-5805-246-10	Operator's Manual: Terminal, Telegraph TH-5/TG.
TM 11-5805-246-20	Organizational Maintenance Manual: Terminal, Telegraph TH-5/TG.
TM 5805-246-20P	Organizational Maintenance Repair Parts and Special Tools Lists: Terminal, Telegraph TH-5/TG and TH-5A/TG.
TM 11-5805-246-35	DS, GS, and Depot Maintenance Manual: Terminal, Telegraph TH-5/TG.
TM 11-5805-246-35P	DS, GS, and Depot Maintenance Repair Parts and Special Tool Lists: Terminals, Telegraph TH-5/TG and TH-5A/TG.
TM 11-5805-257-12P	Operator and Organizational Maintenance Repair Parts and Special Tools List and Maintenance Allocation Chart: Generators, Ringing, Hand G-42/PT and G-42A/PT.

- TM 11-5805-262-12 Operator's and Organizational Maintenance Manual: Switchboards, Telephone, Manual SB-22/PT and SB-22A/PT.
- TM 11-5805-262-20P Organizational Maintenance Repair Parts and Special Tool Lists: Switchboards, Telephone, Manual SB-22/PT and SB-22A/PT.
- TM 11-5805-262-35 Field and Depot Maintenance Manual: Switchboards, Telephone, Manual SB-22/PT and SB-22A/PT.
- TM 11-5805-262-35P DS, GS, and Depot Maintenance Repair Parts and Special Tool Lists: Switchboards, Telephone, Manual SB-22/PT and SB-22A/PT.
- TM 11-5815-206-ESC Operator and Organizational Maintenance Manual: Teletypewriter Set AN/PGC-1 and Teletypewriters TT-4A/TG, TT-4B/TG, TT-4C/TG, and TT-335/TG.
- TM 11-5815-206-20P Organizational Maintenance Repair Parts and Special Tool Lists: Teletypewriter Set AN/PGC-1 and Teletypewriters TT-4A/TG, TT-4B/TG, TT-4C/TG, and TT-335/TG.
- TM 11-5815-206-35 Field and Depot Maintenance Manual: Teletypewriter Set AN/PGC-1 and Teletypewriters TT-4A/TG, TT-4B/TG, TT-4C/TG, and TT-335/TG.
- TM 11-5815-206-35P/1 DS, GS, and Depot Maintenance Repair Parts and Special Tool Lists: Teletypewriter Set AN/PGC-1 Including Teletypewriters TT-4A/TG, TT-4B/TG, TT-4C/TG, and TT-335/TG.
- TM 11-5815-206-35P/2 DS, GS, and Depot Maintenance Repair Parts and Special Tool Lists: Teletypewriter Set AN/PGC-1 Including Teletypewriters TT-4A/TG, TT-4B/TG, TT-4C/TG, and TT-335/TG.
- TM 11-5815-238-12 Organizational Maintenance Manual Including Repair Parts and Special Tools List: Teletypewriter Sets AN/GGC-3 and AN/GGC-3A and Teletypewriter Reperforator-Transmitters TT-76/GGC, TT-76A/GGC, TT-76B/GGC, and TT-76C/GGC.
- TM 11-5815-238-35 DS, GS, and Depot Maintenance Manual: Teletypewriter Sets AN/GGC-3 and AN/GGC-3A and Teletypewriter Reperforator-Transmitters TT-76/GGC, TT-76A/GGC, TT-76B/GGC, and TT-76C/GGC.
- TM 11-5815-238-35P DS, GD, and Depot Maintenance Repair Parts and Special Tool Lists: Teletypewriter Sets AN/GGC-3 and AN/GGC-3A, Reperforator-Transmitters, Teletypewriter TT-76/GGC, TT-76A/GGC, TT-76B/GGC, and TT-76C/GGC.
- TM 11-5830-221-12 Operator's and Organizational Maintenance Manual: Intercommunication Stations LS-147A/FI, LS-147B/FI, LS-147C/FI, and LS-147D/FI.
- TM 11-5830-221-20P Organizational Maintenance Repair Parts and Special Tool Lists: Intercommunication Stations LS-147A/FI, LS-147B/FI, LS-147C/FI, and LS-147D/FI.
- TM 11-5830-221-35 Field and Depot Maintenance Manual: Intercommunication Stations LS-147A/FI, LS-147B/FI, LS-147C/FI, and LS-147D/FI.
- TM 11-5830-221-35P Field and Depot Maintenance Repair Parts and Special Tool Lists: Intercommunication Stations LS-147A/FI, LS-147B/FI, LS-147C/FI, and LS-147D/FI.
- TM 11-5895-223-15 Organizational, DS, GS, and Depot Maintenance Manual: Operations Center, Communications AN/MS-31 Including Repair Parts List.
- TM 11-5965-207-12P Operator's, Organizational Maintenance Repair Parts and Special Tools List and Maintenance Allocation Chart: Handset-Headsets H-81/U and H-81A/U.
- TM 5965-207-35P Field and Depot Maintenance Repair Parts and Special Tools List: Handset-Headsets H-81/U and H-81A/U.

- TM 11-5965-224-15P Operator, Organizational, Field and Depot Maintenance Repair Parts and Special Tool Lists and Maintenance Allocation Chart: Handsets H-60/PT and H-165/U.
- TM 11-5965-271-50 Depot Maintenance Manual: Handsets TS-9-(\*), TS-10-(\*), TS-11-(\*), TS-12-F, TS-13-(\*), TS-14-(\*), TS-15-(\*), H-22-B/U, H-23-(\*)/U, and H-60/PT.
- TM 11-6110-201-15P Operator, Organizational, Field and Depot Maintenance Repair Parts and Special Tool Lists and Maintenance Allocation Chart: Distribution Boxes J-1077/U and J-1077A/U.
- TM 11-6625-203-12 Operator and Organizational Maintenance: Multimeter AN/URM-105 Including Multimeter ME-77/U.
- TM 11-6625-203-20P Organizational Maintenance Repair Parts and Special Tools List: Multimeter AN/URM-105.
- TM 11-6625-203-35 Field and Depot Maintenance Manual: Multimeter AN/URM-105 Including Multimeter ME-77/U.
- TM 11-6625-203-45P Field (Fourth Echelon) and Depot Maintenance Repair Parts and Special Tool Lists: Multimeter AN/URM-105.
- TM 38-750 Army Equipment Record Procedures.

Page 62, appendix II (as changed by C 4, 14 Jan 65). Delete and substitute:

## APPENDIX II

### MAINTENANCE ALLOCATION

---

#### Section I. INTRODUCTION

##### A2-1. General

This appendix provides a summary of the maintenance operations covered in the equipment literature for Operations Central AN/ MSC-82. It authorizes categories of maintenance for specific maintenance functions on repairable items and components and the tools and equipment required to perform each function. This appendix may be used as an aid in planning maintenance operations.

##### A2-2. Explanation of Format for Maintenance Allocation Chart

*a. Group Number.* Group numbers correspond to the reference designation prefix assigned in accordance with ASA Y32.16, Electrical and Electronics Reference Designations. They indicate the relation of listed items to the next higher assembly.

*b. Component Assembly Nomenclature.* This column lists the item names of component units, assemblies, subassemblies, and modules on which maintenance is authorized.

*c. Maintenance Function.* This column indicates the maintenance category at which performance of the specific maintenance function is authorized. Authorization to perform a function at any category also includes authorization to perform that function at higher categories. The codes used represent the various maintenance categories as follows:

Code	Maintenance category
C.....	Operator/Crew
O.....	Organizational Maintenance
F.....	Direct Support Maintenance
H.....	General Support Maintenance
D.....	Depot Maintenance

*d. Tools and Equipment.* The numbers appearing in this column refer to specific tools and equipment which are identified by these numbers in section III.

*e. Remarks.* Self explanatory.

##### A2-3. Explanation of Format for Tool and Test Equipment Requirements

The columns in the tool and test equipment requirements chart are as follows:

*a. Tools and Equipment.* The numbers in this column coincide with the numbers used in the tools and equipment column of the MAC. The numbers indicate the applicable tool for the maintenance function.

*b. Maintenance Category.* The codes in this column indicate the maintenance category normally allocated the facility.

*c. Nomenclature.* This column lists tools, test, and maintenance equipment required to perform the maintenance functions.

*d. Federal Stock Number.* This column lists the Federal stock number.

*e. Tool Number.* Not used.

SECTION II. MAINTENANCE ALLOCATION CHART

GROUP NUMBER	COMPONENT ASSEMBLY NOMENCLATURE	MAINTENANCE FUNCTIONS											TOOLS AND EQUIPMENT	REMARKS			
		INSPECT	TEST	SERVICE	ADJUST	ALIGN	CALIBRATE	INSTALL	REPLACE	REPAIR	OVERHAUL	REBUILD					
1	OPERATIONS CENTRAL AN/MSC-32	C		C C												3 6 6 6 6 6	Preventive maintenance Operational Test in accordance with component maintenance allocation (MAC) Adjust in accordance with component MAC Repair in accordance with component MAC
1A	SHELTER, ELECTRICAL EQUIPMENT S-184, 184A, B, C, D/MSC-32	C		C O												3 1 1,2 3 6 6	Preventive maintenance Continuity of light, power and signal circuits All tests Light, power and signal circuits By component MAC
1A1	BLOWER, EXHAUST			O					F							3 3	Operational Replace motor and impeller
1A2	FIRE EXTINGUISHER															#	Corps of engineers

TM 11-5895-224-15

CS



MAINTENANCE ALLOCATION CHART														
GROUP NUMBER	COMPONENT ASSEMBLY NOMENCLATURE	MAINTENANCE FUNCTIONS								TOOLS AND EQUIPMENT	REMARKS			
		INSPECT	TEST	SERVICE	ADJUST	ALIGN	CALIBRATE	INSTALL	REPLACE			REPAIR	OVERHAUL	REBUILD
	AN/MSC-32 (continued)													
1A3	HEATER, ELECTRICAL 1500 WATTS									#				USAMEC responsibility
1A4	CABLE ASSEMBLIES 26 PAIR		F							F			3	Replace connector
1A5	DISTRIBUTION BOX J-1077A/U									#				TM 11-6110-201-15P
1A6	INTERCOMMUNICATION STATION LS-147C/FI									#				TM 11-5830-221-12
1A7	SHELTER, ELECTRICAL EQUIPMENT S-141/G									#				TM 11-5410-206-12P
1B	SWITCHBOARD, TELEPHONE SB-22A/PT									#				TM 11-5805-262-12
1C	TELEPHONE SET TA-312/PT									#				TM 11-5805-201-12
1D	TELETYPEWRITER SET AN/GGC-3A; TELETYPEWRITER REPERFORATOR TT-76, A, B/GGC									#				TM 11-5815-238-12
1E	TELETYPEWRITER SET AN/PGC-1; TELETYPEWRITER TT-4 A, B, C/TG									#				TM 11-5815-206-12
1F	TERMINAL, TELEGRAPH TH-5/TG									#				TM 11-5805-246-20
	#Indicates that maintenance guidance will be found in documents referenced in remarks column.													

## SECTION III. TOOL AND TEST EQUIPMENT REQUIREMENTS

10

TOOLS AND EQUIPMENT	MAINTENANCE CATEGORY	NOMENCLATURE	FEDERAL STOCK NUMBER	TOOL NUMBER
1	O,F,H,D	AN/MS-32 (continued) MULTIMETER TS-352/U (TO BE REPLACED BY AN/USM-223)	6625-581-2036	
2	H,D	OHMMETER ZM-21A/U	6625-246-5880	
3	O,F	TOOL EQUIPMENT TE-123	5180-408-1881	
4	H,D	TOOL KIT, ELECTRONIC EQUIPMENT SHELTER TK-144/G	5180-987-4369	
5	F,H,D	TOOL KIT, GENERAL MECHANIC	5180-754-0641	
6	O,F,H,D	TOOLS AND TEST EQUIPMENT ASSOCIATED COMPONENTS. F END ITEM		
NOTE: DEPOT MAY USE ANY OTHER EQUIPMENT REQUIRED TO OVERHAUL OR REBUILD THIS EQUIPMENT				

TM 11-5895-224-15

CS

Page 68, appendix III (as changed by C 4, 14 Jan 65). Delete and substitute:

## APPENDIX III

### BASIC ISSUE ITEMS

#### Section I. INTRODUCTION

#### A3-1. General

This appendix lists items for Operations Central AN/MS-32, the component items comprising it, and the items which accompany it, or are required for installation, operation, or operator's maintenance.

#### A3-2. Explanation of Columns

An explanation of the columns in section II is given below.

##### a. Source, Maintenance, and Recoverability Codes, Column 1.

- (1) *Source code, column 1a.* Not used.
- (2) *Maintenance code, column 1b.* Not used.
- (3) *Recoverability code, column 1c.* The information in this column indicates whether unserviceable items should be returned for recovery or salvage. Recoverability code and its explanation is as follows:

*Note.* When no code is indicated in the recoverability column, the part will be considered expendable.

Code	Explanation
R-----	Applies to repair parts and assemblies that are economically repairable at DSU and GSU activities and are normally furnished by supply on an exchange basis.

*b. Federal Stock Number, Column 2.* The Federal stock number for the item is indicated in this column.

*c. Description, Column 3.* The Federal item name, a five-digit manufacturer's code, a part

number, and when required, the model designator (\*), which indicates different models of the end equipment, are included in this column.

*d. Unit of Issue, Column 4.* The unit used as a basis of issue (e.g. ea, pr, ft, yd, etc) is noted in this column.

*e. Quantity Incorporated in Unit pack, Column 5.* Not used.

*f. Quantity Incorporated in Unit, Column 6.* The total quantity of the item used in the equipment is given in this column.

*g. Quantity Authorized, Column 7.* The total quantity of an item required to be on hand and necessary for the operation and maintenance of the equipment is given in this column.

*h. Illustration, Column 8.*

- (1) *Figure number, column 8a.* The number of the illustration in which the item is shown is indicated in this column.
- (2) *Item or symbol number, column 8b.* Not used.

#### A3-3. Batteries

Dry batteries shown are used with the equipment but are not considered part of the equipment. They will not be preshipped automatically but are to be requisitioned in quantities necessary for the particular organization, in accordance with SB 11-6.

## SECTION II. BASIC ISSUE ITEMS LIST

(1)			(2) FEDERAL STOCK NUMBER	(3) DESCRIPTION						(4) UNIT OF ISSUE	(5) QTY INC IN UNIT PACK	(6) QTY INC IN UNIT	(7) QTY AUTH	(8) ILLUSTRATIONS	
SOURCE CD (A)	MAINT. CD (B)	REC. CODE (C)		MODEL										(A) FIGURE NUMBER	(B) ITEM OR SYMBOL NUMBER
				1	2	3	4	5	6						
			5895-021-2090												
		R	5965-682-2769												
		R	5815-503-2760												
		R	5815-553-6061												
		R	5410-752-9621												
		R	5805-257-3602												
		R	5805-543-0012												
		R	5815-198-4438												
		R	5805-246-8734												

TM 11-5895-224-15

CS

(1) SOURCE CD MAINT. CD REC. CODE			BASIC ISSUE ITEMS LIST						(4) UNIT OF ISSUE	(5) QTY INC IN UNIT PACK	(6) QTY INC IN UNIT	(7) QTY AUTH	(8) ILLUSTRATIONS		
			(2) FEDERAL STOCK NUMBER	(3) DESCRIPTION									(a) FIGURE NUMBER	(b) ITEM OR SYMBOL NUMBER	
				MODEL											
1	2	3	4	5	6										
							AN/MSC-32 (continued)								
							SHELTER, ELECTRICAL EQUIPMENT S-184/MSC, S-184A, B, C, D/MSC-32 (S-141/G SHELTER MODIFIED)								
							NOTE: Model column 1 refers to S-184/MSC-32; column 2 refers to S-184A/MSC-32; column 3 refers to S-184B/MSC-32; column 4 refers to S-184C/MSC-32; column 5 refers to S-184D/MSC-32								
	4210-727-8111	*	*	*	*		AXE, PICKHEAD: 02461; 276	ea		1	1	14			
	5110-293-2339	*	*	*	*		AXE: 81349; GGG-A-926, type 1, class 1, design B	ea		1	1	14			
	7520-753-4807	*	*	*	*		BASKET, WASTEPAPER: 85838; 36	ea		3	3	12			
	7502-292-9493	*	*	*	*		BASKET, WASTEPAPER: 81349; RR-B-181, type II, style B, gray	ea		3	3				
	6135-120-1020	*	*	*	*		BATTERY, DRY BA-30	ea			4				
	7920-178-8315	*	*	*	*		BRUSH DUSTING, BENCH: 80063; SC-C-539469	ea		1	1	14			
	5995-823-2715	*	*	*	*		CABLE ASSEMBLY AND REEL: Consists of CX-4566A/G, 250 ft lg, and Reel RC-435/U	ea		1	1	3			
	5410-752-2435	*	*	*	*		CABLE ASSEMBLY AND REEL: Consists of CX-7453/U, 100 ft lg, and Reel RC-435/U	ea		1	1	3			
	5995-752-2548	*	*	*	*		CABLE ASSEMBLY, POWER ELECTRICAL CX-7705/U: 15 ft lg power stub	ea		1	1	2			
	4940-752-2474	*	*	*	*		CABLE ASSEMBLY, POWER ELECTRICAL: Line cord; 80063; SM-D-350987	ea		1	1	2			
	5995-823-2620	*	*	*	*		CABLE ASSEMBLY, SPECIAL PURPOSE: F/headset; 80063; SM-C-382135	ea		1	1	2			
	5995-889-0803	*	*	*	*		CABLE ASSEMBLY, TELEPHONE CX-4760A/U: 15 ft lg	ea		1	1	2			

(1)			BASIC ISSUE ITEMS LIST										(4)	(5)	(6)	(7)	(8)	
SOURCE CD (A)	MAINT. CD (B)	REC. CODE (C)	(2) FEDERAL STOCK NUMBER	(3) DESCRIPTION						(4) UNIT OF ISSUE	(5) QTY INC IN UNIT PACK	(6) QTY INC IN UNIT	(7) QTY AUTH	(8)				
				MODEL										(A) FIGURE NUMBER	(B) ITEM OR SYMBOL NUMBER			
				1	2	3	4	5	6									
			5995-752-2566	*	*	*	*	*	AN/MSC-32 (continued)	ea		5	5	3				
			5995-889-0923	*	*	*	*	*	CABLE ASSEMBLY, TELEPHONE: F/LS-147C/FI and TA-312/PT; 4 ft lg; 80063; SM-D-383873-GR III	ea		1	1	23				
			5995-823-3016	*	*	*	*	*	CABLE ASSEMBLY, TELEPHONE: F/TTY; black plug; 6 ft lg; 80063; SM-D-384145-GR I	ea		2	2	2				
			5995-889-0608	*	*	*	*	*	CABLE ASSEMBLY, TELEPHONE: F/TTY; ref plug; 6 ft lg; 80063; SM-D-384145-GR II	ea		2	2	2				
			7105-943-3868	*	*	*	*	*	CHAIR, FOLDING: 80063; SC-D0539471	ea		3	3	15				
			7110-273-8798	*	*	*	*	*	CHAIR, ROTARY (NOTE: When replacing chair remove and retain mounting bracket for installation on new chair.)	ea		1	1	12				
	R		6645-800-7094	*					CLOCK, AIRCRAFT, MECHANICAL: 80063; SC-C-539475	ea		1	1	13				
	R		6645-303-4950	*	*			*	CLOCK, AIRCRAFT, MECHANICAL: 81349; MIL-C-7939A, type AT-11, AN/5743-2 (NOTE: When replacing retain mtg bkt for installing new clock.)	ea		1	1	13				
	R		6645-526-4395	*				*	CLOCK, AIRCRAFT MECHANICAL: 80063; SM-B-472589-5 (NOTE: When replacing retain mtg bkt for installing new clock.)	ea		1	1	13				
			6605-892-5399	*	*	*	*	*	COMPASS, MAGNETIC: 81349; MIL-C-10436	ea		1	1					
			5995-752-2516	*	*	*	*	*	CORD ASSEMBLY, ELECTRICAL: 2 ft 6 in lg; black; 80063; SM-D-352593-GR III	ea		3	3	3				
			5995-752-2515	*	*	*	*	*	CORD ASSEMBLY, ELECTRICAL: 2 ft 6 in lg; red; 80063; SM-D-352594-GR III	ea		3	3	3				
			5995-752-2594	*	*	*	*	*	CORD ASSEMBLY, ELECTRICAL: 2 ft 6 in lg; white; 80063; SM-D-352595-GR III	ea		3	3	3				
			5995-752-2593	*	*	*	*	*	CORD ASSEMBLY, ELECTRICAL: 2 ft 6 in lg; green; 80063; SM-D-352596-GR III	ea		4	4	3				

SOURCE CD (1)	MAINT. CD (2)	REC. CODE (3)	BASIC ISSUE ITEMS LIST						(4) UNIT OF ISSUE	(5) QTY INC IN UNIT PACK	(6) QTY INC IN UNIT	(7) QTY AUTH	(8) ILLUSTRATIONS		
			(2) FEDERAL STOCK NUMBER	(3) DESCRIPTION									(A) FIGURE NUMBER	(B) ITEM OR SYMBOL NUMBER	
				MODEL											
1	2	3	4	5	6										
							AN/MSC-32 (continued)								
		R	5995-752-2597	*	*	*	CORD ASSEMBLY, ELECTRICAL: 2 ft 6 inlg; gray; 80063; SM-D-597-GR III	ea		1	1	3			
			7210-753-3043	*	*	*	CUSHION, CHAIR: 80063; SM-C-350214	ea		3	3	7			
		R	6110-649-8146	*	*	*	DISTRIBUTION BOX J-1077A/U	ea		1	1	13			
			5960-262-0185	*	*	*	ELECTRON TUBE: 81349; 5726/6AL5W	ea		6	2				
			5960-262-0152	*	*	*	ELECTRON TUBE: 81349; 6AU6WA	ea		1	1				
			5960-188-0880	*	*	*	ELECTRON TUBE: 81349; 6X4W	ea		1	1				
			5960-669-6861	*	*	*	ELECTRON TUBE: 81349; 6005/6AQ5W	ea		1	1				
			5960-166-7663	*	*	*	ELECTRON TUBE: 81349; 12AU7	ea		1	2				
		R	5960-166-7664	*	*	*	ELECTRON TUBE: 81349; 12AX7	ea		1	1				
		R	4210-383-7128	*	*	*	EXTINGUISHER, FIRE: 2-1/2 lb; 33525; 2-1/2T2	ea		1	1	11			
		R	4120-383-7129	*	*	*	EXTINGUISHER, FIRE: 5 lb; 80063; SC-D-539482	ea		1	1	14			
			5120-408-1481	*	*	*	EXTRACTOR, ELECTRON TUBE: F/7 pin; 73917; TP-11-16	ea		1	1	14			
			5120-293-2692	*	*	*	EXTRACTOR, ELECTRON TUBE: F/9 pin; 73917; TP-13-16	ea		1	1	14			
			6545-822-3166	*	*	*	FIRST AID KIT: 80063; SM-C-349935	ea		1	1	14			
			6545-922-1200	*	*	*	FIRST AID KIT	ea		1	1	14			
			6645-663-9032	*	*	*	FIRST AID KIT: 81349; GG-K-392, type 2, size 1	ea		1	1				
			5920-356-2188	*	*	*	FUSE, CARTRIDGE: 81349; FO2GR125A	ea		1	5				
			5920-636-3047	*	*	*	FUSE, CARTRIDGE: 1 amp; 75915; 313.001	ea		1	5				
			5920-280-9328	*	*	*	FUSE, CARTRIDGE: 81349; FO2DIR50B	ea		1	5				
			5920-224-5269	*	*	*	FUSE, CARTRIDGE: 1.6 amp; 75915; 313.016	ea		1	5				

SOURCE CD (1)	MAINT. CD (2)	REC. CODE (3)	BASIC ISSUE ITEMS LIST						(4) UNIT OF ISSUE	(5) QTY INC IN UNIT PACK	(6) QTY INC IN UNIT	(7) QTY AUTH	(8) ILLUSTRATIONS		
			(2) FEDERAL STOCK NUMBER	(3) DESCRIPTION									(A) FIGURE NUMBER	(B) ITEM OR SYMBOL NUMBER	
				MODEL											
1	2	3	4	5	6										
							AN/MSC-32 (continued)								
			5920-581-4144	*	*	*	FUSE, CARTRIDGE: 2 amp; 71400; MDX-2 (2 mtd in equip)	ea		2	7				
			5120-776-9917	*	*	*	GRIP, CABLE, JAW: approx 16 in lg; 95344; EQA-6-8P	ea		13	13	2			
			5120-776-9918	*	*	*	GRIP, CABLE, JAW: approx 12 in lg; 95344; EQA-26S	ea		12	12	2			
			5120-251-4489	*	*	*	HAMMER, HAND: 79796; 15	ea		1	1	14			
			5120-793-2027	*	*	*	HANDLE, HAMMER: 79796; AW30	ea		1	1	14			
	R		4520-224-7909	*	*	*	HEATER SPACE, ELECTRICAL: 80063; SC-D-539485	ea		2	2	12			
	R		5830-752-5357	*	*	*	INTERCOMMUNICATION STATION LS-1470/FI	ea		1	1	13			
			2540-892-6243	*	*	*	LADDER, BOARDING, VEHICLE MX-3391/G	ea		1	1	15			
			6240-538-8447	*	*	*	LAMP, FLUORESCENT: 08808; F20T12CW	ea		8	2	4			
			6240-299-5876	*	*	*	LAMP, GLOW NE-34	ea		1	1	4			
			6240-179-1814	*	*	*	LAMP, GLOW NE-45	ea		6	2	1			
			6240-223-9100	*	*	*	LAMP, GLOW NE-51	ea		3	1				
			6240-155-8706	*	*	*	LAMP, INCANDESCENT: 81349; MS15571-2, type TB-14	ea		1	1				
			6240-892-6102	*	*	*	LAMP, INCANDESCENT: 08808; 1007/5DC	ea		1	1				
			6240-143-3084	*	*	*	LAMP, INCANDESCENT: 08808; 15T7/DC (mtd in equip)	ea		1	1				
			6240-143-3060	*	*	*	LAMP, INCANDESCENT: 08808; 6S6DC-120	ea		1	1				
			6240-196-4501	*	*	*	LAMP, INCANDESCENT: 80063; SC-D-84552-6	ea		1	1				
			6240-143-3070	*	*	*	LAMP, INCANDESCENT: 08808; 50W/RS	ea		3	3	4			
			6240-155-7786	*	*	*	LAMP, INCANDESCENT: 08808; PR-2 (mtd in lantern)	ea		1	1	4			
			6230-729-9614	*	*	*	LANTERN, ELECTRICAL: 32572; 2106-7	ea		1	1	14			



SOURCE CD (1)	MAINT. CD (2)	REC. CODE (3)	BASIC ISSUE ITEMS LIST							(4) UNIT OF ISSUE	(5) QTY INC IN UNIT PACK	(6) QTY INC IN UNIT	(7) QTY AUTH	(8) ILLUSTRATIONS	
			(2) FEDERAL STOCK NUMBER	(3) DESCRIPTION										(a) FIGURE NUMBER	(b) ITEM OR SYMBOL NUMBER
				MODEL											
1	2	3	4	5	6										
							AN/MS-C-32 (continued)								
							5410-752-2525 * * * * *	LEAD, ELECTRICAL: 80063; SM-B-539592	ea		2	2	2		
							6230-615-5384 * * * * *	LIGHT, EXTENSION: 81349; W-L-661, type 1, class 1	ea		1	1	2		
							7510-240-1526 * * * * *	PENCIL, GREASE: Black	ea		4	4	11		
							7510-436-5210 * * * * *	PENCIL, GREASE: Blue	ea		4	4	11		
							7510-275-7212 * * * * *	PENCIL, GREASE: Green	ea		4	4	11		
							7510-174-3205 * * * * *	PENCIL, GREASE: Red	ea		4	4	11		
							7510-264-4612 * * * * *	PENCIL, GREASE: Yellow	ea		4	4	11		
							5120-293-3603 * * * * *	PIN STRAIGHTENER, ELECTRON TUBE: 72653; 8655	ea		1	1			
							5975-224-5260 * * * * *	ROD, GROUND MX-148/G	ea		2	2	14		
							5120-752-9675 * * * * *	SCREWDRIVER: 08600; 2143-6	ea		1	1			
							6130-076-3545 * * * * *	SEMICONDUCTOR DEVICE, DIODE: 80063; SC-C-141342	ea		12	1			
							6130-076-3546 * * * * *	SEMICONDUCTOR DEVICE, DIODE: 80063; SC-C-141343	ea		6	1			
							7520-162-6178 * * * * *	SHARPENER, PENCIL: 80063; SC-C-539503	ea		1	1	14		
							6210-752-8134 * * * * *	SHIELD, LIGHT: 80063; SM-C-349983	ea		8	8	7		
							6250-299-2884 * * * * *	STARTER, FLUORESCENT: 71183; FS-2	ea		8	6	4		
							5410-792-6336 * * * * *	STRAP ASSEMBLY, TIE DOWN: 98313; FDC-1575101-1	ea		6	6	2		
							5210-221-1882 * * * * *	TAPE, MEASURING: 86794; SV100G/0572	ea		1	1			
		R					5805-503-3337 * * * * *	TELEPHONE CIRCUIT, LINE JACK TA-222/PT	ea		12	2			
							5805-715-6175 * * * * *	TELEPHONE CIRCUIT, TRUNK JACK TA-326/PT	ea		1	1			

SOURCE CD (A)	(1)		BASIC ISSUE ITEMS LIST										(4) UNIT OF ISSUE	(5) QTY INC IN UNIT PACK	(6) QTY INC IN UNIT	(7) QTY AUTH	(8) ILLUSTRATIONS								
	MAINT. CD (B)	REC. CODE (C)	(2) FEDERAL STOCK NUMBER	(3) DESCRIPTION						(A) FIGURE NUMBER	(B) ITEM OR SYMBOL NUMBER														
				MODEL																					
			1	2	3	4	5	6																	
			AN/MSC-32 (continued)																						
			ACCESSORIES, TOOLS, AND TEST EQUIPMENT																						
			7530-223-7966	*	*	*	*	*	*	PAPER, RECORDING, TELETYPEWRITER: 81349; UU-P-547C, type 1, class 1										ea		1	1		
			7511-511-6690	*	*	*	*	*	*	RIBBON, PRINTING, TELETYPEWRITER: 81349; DDD-R-31LD, type 1, grade A, class 1										ea		1	1		
			7530-634-6237	*	*	*	*	*	*	TAPE TELETYPEWRITER: 31349; UU-T-120										ea		1	4		
			NO BASIC ISSUE ITEMS ARE MOUNTED IN OR ON THIS EQUIPMENT																						

Page 71. Add appendix IV after appendix III.

## APPENDIX IV

### ORGANIZATIONAL, DS, GS, AND DEPOT REPAIR PARTS

---

#### Section 1. INTRODUCTION

##### A4-1. General

This appendix contains a list of repair parts required for the performance of organizational maintenance and a list covering the corresponding requirements for direct support, general support, and depot maintenance for Operations Central AN/MS-32.

*Note.* No special tools, tests, and support equipment are required.

##### A4-2. Explanation of Sections

This repair parts list is divided into four principal parts:

*a. Prescribed Load Allowance List (PLA), Section II.* The PLA is a consolidated listing of repair parts allocated for initial stockage at organizational maintenance. This is a mandatory minimum stockage allowance.

*b. Repair Parts, Organizational Maintenance, Section III.* Repair parts authorized for organizational maintenance is included in this section.

*c. Repair Parts, DS, GS, and Depot Maintenance, Section IV.* This chart lists repair parts authorized for maintenance performance at direct support, general support, and depot.

*d. Federal Stock Number Index, Section V.* This is a cross-reference index of Federal stock numbers to illustrations by figure and item number.

##### A4-3. Explanation of Columns

An explanation of the columns in sections II through IV is given below.

*a. Source, Maintenance, and Recoverability Codes, Column 1, Sections III and IV.*

- (1) *Source code, column 1a.* The selection status and source for the listed item is noted here. Source code and its explanation is as follows:

Code	Explanation
P-----	Applies to repair parts that are stocked in or supplied from the GSA/DSA, or Army system, and authorized for use at indicated maintenance categories.

- (2) *Maintenance code, column 1b.* The lowest category of maintenance authorized to install the listed item is noted here.

Code	Explanation
O-----	Organizational Maintenance
F-----	Direct Support Maintenance
H-----	General Support Maintenance

- (3) *Recoverability code, column 1c.* The information in this column indicates whether unserviceable items should be returned for recovery or salvage. Recoverability code and its explanation is as follows:

*Note.* When no code is indicated in the recoverability column, the part will be considered expendable.

Code	Explanation
R-----	Applies to repair parts and assemblies which are economically repairable at DSU and GSU activities and normally are furnished by supply on an exchange basis.

b. *Federal Stock Number, Column 1, Section II; Column 2, Sections III and IV.* The Federal stock number for the item is indicated in this column.

c. *Description, Column 2, Section II; Column 3, Sections III and IV.* The model designator, Federal item name, a five-digit manufacturer's code, and a part number are included in this column. The designator (\*) indicates the different models of the end equipment.

d. *Unit of Issue, Column 4, Sections III and IV.* The unit used as a basis of issue (e.g. ea, pr, ft, yd, etc) is noted in this column.

e. *Quantity Incorporated in Unit Pack, Column 4, Section II; Column 5, Sections III and IV.* Not used.

f. *Quantity Incorporated in Unit, Column 6, Sections III and IV.* The quantity of repair parts in an assembly is given in this column.

g. *Maintenance Allowance, Column 3, Section II; Column 7, Sections III and IV.*

- (1) The allowance columns are divided into subcolumns. The total quantity of items authorized for the number of equipments supported is indicated in each subcolumn. Items authorized for use as required but not for initial stockage are identified with an asterisk (\*) in the allowance column.
- (2) The quantitative allowances for organizational category of maintenance represents one initial prescribed load for a 15-day period for the number of equipments supported. Units and organizations authorized additional prescribed loads will multiply the number of prescribed loads authorized by the quantity of repair parts reflected in the appropriate density column to obtain the total quantity of repair parts authorized.
- (3) Subsequent changes to organizational allowances will be limited as follows: No change in the range of items is authorized. If additional items are considered necessary, recommendation should be forwarded to Commanding General, US. Army Electronics Command, ATTN: AMSEL-ME-NMP-CW, Fort Monmouth, N.J., 07703,

for exception or revision to the allowance list. Revisions to the range of items authorized will be made by the USA ECOM National Maintenance Point based upon engineering experience, demand data, or TAERS information.

- (4) The quantitative allowances for DS/GS categories of maintenance will represent initial stockage for a 30-day period for the number of equipments supported.

h. *One-Year Allowances Per 100 Equipments/Contingency Planning Purposes, Column 8, Section IV.* Opposite each item, the total quantity required for distribution and contingency planning purposes is indicated. The range of items indicates total quantities of all authorized items required to provide for adequate support of 100 equipments for 1 year.

i. *Illustration, Column 8, Section III; Column 10, Section IV.*

- (1) *Figure number, columns 8a and 10a.* The number of the illustration in which the item is shown is indicated in this column.
- (2) *Item or symbol number, columns 8b and 10b.* The callout number used to reference the item in the illustration is indicated in this column.

j. *Depot Maintenance Allowance Per 100 Equipments, Column 9, Section IV.* This column indicates the total quantity of each item authorized depot maintenance for 100 equipments.

#### A4-4. Location of Repair Parts

a. When the Federal stock number is unknown, follow the procedures given in (1) through (4) below.

- (1) Locate the appropriate appendix of the repair parts list.
- (2) If the item or symbol number is available, locate the item by scrutiny of columns 8b and/or 10b of the repair parts list.
- (3) If the item, symbol, or figure number is not known, check the description column (col 3) in the repair parts list to locate the part. The parts in

this column are arranged in alphabetical order.

- (4) Locate the applicable illustration in this manual and note the figure number and item number. Use the repair parts listing and locate the figure and/or item number as noted on the illustration.

b. When the Federal stock number is known, use the repair part listing to find the repair part and the figure and item numbers as noted in the Federal stock number index.

#### A4-5. Federal Supply Codes

This paragraph lists the Federal supply code and the associated manufacturer's name.

Code no.	Manufacturer
00656	AEROVOX Corp.
02461	American Logging Tool Co.
02777	Hopkins Engineering Co.
06229	Electrovert, Inc.
08600	Bridgeport Hardware Mfg. Corp.
08621	Swivelier Co., Inc.
08808	General Electric Co., Lamp Glass Dept.
16748	Delco Appliance Div of General Motors Corp.

Code no.	Manufacturer
24453	General Electric Distributing Corp.
32572	Justrite Mfg. Co.
33525	Kidde Walter and Co., Inc.
71183	Bryant Electric Co.
71400	Bussmann Mfg., Division of McGraw-Edison Co.
72619	Dialight Corp.
72653	G. C. Electronics Co.
73586	Circle F Industries
73917	Kellems Co.
74545	Hubbell Harvey, Inc.
75915	Littlefuse, Inc.
77166	Pass and Seymour, Inc.
78674	Swivelier Co., Inc.
79796	Woodings Verona Tool Works
80063	Army Electronics Command Procurement and Production Directorate
81349	Military Specifications
82877	Rotron Mfg. Co., Inc.
85838	Erie Art Metal Co., Inc.
86794	Roe Justus and Sons
89285	Benjamin Electric Mfg. Co.
90211	Square D Co.
91929	Honeywell, Inc., Micro Switch Division
93993	Midwest Electric Products, Inc.
95344	Economy Cable Grip Co.
98313	Davis Aircraft Products, Inc.

SECTION II. PRESCRIBED LOAD ALLOWANCE LIST

(1) FEDERAL STOCK NUMBER	(2) DESCRIPTION	MODEL DESIGNATOR	(3) 15-DAY ORG. MAINT. ALLOWANCE				(4) QTY INC IN UN PK
			(A)	(B)	(C)	(D)	
			1-5	6-20	21-50	51-100	
	SHELTER, ELECTRICAL EQUIPMENT S-184/MSC-32, S-184A, B, C, D/MSC-32  NOTE: Model column 1 refers to S-184/MSC-32; column 2 refers to S-184A/MSC-32; column 3 refers to S-184B/MSC-32; column 4 refers to S-184C/MSC-32; column 5 refers to S-184D/MSC-32						
2540-892-6243	LADDER, VEHICLE, BOARDING MX-3391/G	* * * * *	*	*	*	2	
2590-831-6944	CLIP, RETAINING: Holds cable in cradle clips; O6229; N-5	* * * *	*	*	*	2	
5120-776-9917	GRIP, CABLE JAW: Approx 16 in lg; 95344; EQA-6-8F	* * * * *	*	*	2	2	
5120-776-9918	GRIP, CABLE, JAW: Approx 12 in lg; 95344; EQA-26S	* * * * *	*	*	2	2	
5340-857-1424	CLIP, RETAINING: Holds cable in cradle clips; O6229; N-1	* * * *	*	2	2	3	
5340-857-1424			*	*	2	2	
5410-792-6335	TIE DOWN PLATE ASSEMBLY: 98313; FDC-1225M5	* * * * *	*	*	*	2	
5410-792-6336	STRAP ASSEMBLY, TIE DOWN: 98313; FDC-1575101-1	* * * * *	*	*	2	2	
5910-553-6096	CAPACITOR, FIXED, PAPER DIELECTRIC: F/fluorescent; O2777; 591B	* * * * *	*	*	2	2	
5910-713-8313	CAPACITOR, FIXED, PAPER DIELECTRIC: F/fan; O0656; P150F83	* * * *	*	*	*	2	
5925-523-5764	CIRCUIT BREAKER: 90211; Q0-120	* * * * *	*	*	2	2	
5925-682-1061	CIRCUIT BREAKER: 90211; Q0-115	* * * * *	*	*	2	2	
5930-075-7231	SWITCH, TOGGLE: 08808; 5051-1		*	*	2	2	
5930-548-5150	SWITCH, TOGGLE: 73586; 3036	* * * *	*	*	*	2	
5930-615-7896	SWITCH, TOGGLE: 81349; MS25098-22	* * * * *	*	*	2	2	
5930-636-4014	SWITCH, TOGGLE: 08808; 5521-1	* * * * *	*	*	2	2	
5935-045-9830	CONNECTOR, PLUG, ELECTRICAL U-185B/G: F/26 pr cable assys	* * * * *	*	*	2	2	
5935-064-5731	CONNECTOR, PLUG, ELECTRICAL U-237/G: F/pwr cable assys	* * * * *	*	*	2	2	
5935-064-5732	CONNECTOR, RECEPTACLE, ELECTRICAL U-238/G: Mtd in pwr ent box	* * * * *	*	*	*	2	
5935-192-4826	JACK, TELEPHONE: 81349; JJ-086	* * * * *	*	*	2	2	
5935-199-0275	CONNECTOR, RECEPTACLE, ELECTRICAL: 74545; 9213	* * * *	*	*	2	2	
5935-228-4038	JACK, TELEPHONE: 81349; JJ-085	* * * * *	*	*	2	2	
5935-259-3313	CONNECTOR, RECEPTACLE, ELECTRICAL: 74545; 7210B	* * * * *	*	*	*	2	

PRESCRIBED LOAD ALLOWANCE										
(1) FEDERAL STOCK NUMBER	(2) DESCRIPTION	MODEL DESIGNATOR				(3) 15-DAY ORG. MAINT. ALLOWANCE				(4) QTY INC IN UN PK
						(A)	(B)	(C)	(D)	
		1-5	6-20	21-50	51-100					
	AN/MS-32 (continued)									
5935-283-1269	JACK, TELEPHONE: 80063; SC-D-19393	*	*	*	*	*	*	*	2	
5935-295-3129	CONNECTOR, RECEPTACLE, ELECTRICAL: Duplex; 74545; 5262				*	*	*	2	2	
5935-359-6025	CONNECTOR, RECEPTACLE, ELECTRICAL: Simplex; 74545; 9210	*	*	*	*	*	*	2	2	
5935-549-3562	CONNECTOR, RECEPTACLE, ELECTRICAL: Duplex; 74545; 9200	*	*	*	*	*	*	2	2	
5935-594-3562					*	*	*	*	2	
5935-646-5908	CONNECTOR, PLUG, ELECTRICAL: 74545; 9754	*	*	*	*	*	*	2	2	
5935-682-0381	CONNECTOR, RECEPTACLE, ELECTRICAL U-187/G	*	*	*	*	*	*	*	2	
5940-223-5293	POST BINDING U-106/U	*	*	*	*	*	*	2	2	3
5940-254-2244	CAP, ELECTRICAL: F/U-106/U; 80063; SC-C-76202-1	*	*	*	*	*	*	2	2	3
5975-656-5260	ROD, GROUND MX-148/G	*	*	*	*	*	*	2	2	
5975-705-5841	CLIP, RETAINING: Holds cable in cradle clips; 06229; N-3	*	*	*	*	*	*	*	2	
5975-705-5841					*	*	*	2	2	
5995-752-2515	CORD ASSEMBLY, ELECTRICAL: 2 ft 6 in lg; red; 80063; SM-D-352594-GR III	*	*	*	*	*	*	2	2	
5995-752-2516	CORD ASSEMBLY, ELECTRICAL: 2 ft 6 in lg; black; 80063; SM-D-352593-GR III	*	*	*	*	*	*	2	2	
5995-752-2566	CABLE ASSEMBLY, TELEPHONE: F/LS-147C/FI and TA-312/PT; 4 ft lg; 80063; SM-D-383873-GR III	*	*	*	*	*	*	2	2	
5995-752-2593	CORD ASSEMBLY, ELECTRICAL: 2 ft 6 in lg; green; 80063; SM-D-352596-GR III	*	*	*	*	*	*	2	2	
5995-752-2594	CORD ASSEMBLY, ELECTRICAL: 2 ft 6 in lg; white; 80063; SM-D-352595-GR III	*	*	*	*	*	*	2	2	
5995-823-3016	CABLE ASSEMBLY, TELEPHONE: F/TTY; black plug; 6 ft lg; 80063; SM-D-384145-GR I	*	*	*	*	*	*	*	2	
5995-889-0608	CABLE ASSEMBLY, TELEPHONE: F/TTY; red plug; 80063; SM-D-384145-GR II	*	*	*	*	*	*	*	2	
6105-561-6321	MOTOR ALTERNATING CURRENT: 16748; A8265M1	*	*		*	*	*	*	2	
6105-792-8384	MOTOR, ALTERNATING CURRENT: 82877; 23396-01	*	*		*	*	*	*	2	
6210-754-8134	SHIELD LIGHT: F/fluorescent; 80063; SM-C-349983	*	*	*	*	*	*	2	2	
6230-615-5384	LIGHT, EXTENSION: 81349; W-L-661, type 1, class 1	*	*	*	*	*	*	*	2	
6230-729-9614	LANTERN, ELECTRIC: 32572; 2106-7	*	*	*	*	*	*	*	2	

PRESCRIBED LOAD ALLOWANCE									
(1) FEDERAL STOCK NUMBER	(2) DESCRIPTION	(3) 15-DAY ORG. MAINT. ALLOWANCE				(4) QTY INC IN UN PK			
		MODEL DESIGNATOR							
		(A) 1-5	(B) 6-20	(C) 21-50	(D) 51-100				
	AN/MSC-32 (continued)								
6240-143-3070	LAMP, INCANDESCENT: 08808; 50W/RS	*	*	*	*	*	2	2	3
6240-155-7786	LAMP, INCANDESCENT: F/lantern; 08808; PR-2	*	*	*	*	*	*	2	2
6240-179-1814	LAMP, GLOW NE-45	*	*	*	*	*	2	2	3
6240-299-5876	LAMP, GLOW NE-34	*	*	*	*	*	*	*	2
6240-538-8447	LAMP, FLUORESCENT: 08808; F20T12/CW	*	*	*	*	*	2	3	5
6250-174-4684	LAMPHOLDER: F/fluorescent; incl starter socket; 08808; 78X736	*	*	*	*	*	*	*	2
6250-299-2884	STARTER, FLUORESCENT LAMP: 71183; FS-2	*	*	*	*	*	2	2	3
6250-299-6093	LAMPHOLDER: F/fluorescent; 08808; 78X491	*	*	*	*	*	*	*	2
6250-752-1233	LAMPHOLDER: 72619; 4-74-6	*	*	*	*	*	*	2	2
6250-804-3449	BALLAST, LAMP: F/fluorescent; 08808; 89G457D	*	*	*	*	*	*	2	2



SECTION III. REPAIR PARTS FOR ORGANIZATIONAL MAINTENANCE

SOURCE CD 1	MAINT. CD 2	REC. CODE 3	(2) FEDERAL STOCK NUMBER						(3) DESCRIPTION	(4) UNIT OF ISSUE	(5) QTY INC IN UN PK	(6) QTY INC IN UNIT	(7) 15 DAY ORG. MAINT. ALW.				(8) ILLUSTRATIONS	
			MODEL										(A) FIGURE NUMBER	(B) ITEM OR SYMBOL NUMBER	(A)	(B)	(C)	(D)
			1	2	3	4	5	6										
			5895-021-2090															
								OPERATIONS CENTRAL AN/MSC-32 (This item is nonexpendable.)  SHELTER, ELECTRICAL EQUIPMENT S-184/MSC-32, S-184A, B, C, D/MSC-32  NOTE: Model column 1 refers to S-184/MSC-32; column 2 refers to S-184A/MSC-32; column 3 refers to S-184B/MSC; column 4 refers to S-184C/MSC-32; column 5 refers to S-184D/MSC-32.										
P	0		6625-892-5315	*	*	*	*	AMMETER: 81349; MR36W050SPECR	ea	1	*	*	*	*	41		M2	
P	0		4210-727-8111	*	*	*	*	AXE, PICKHEAD: 02461; 276	ea	1	*	*	*	*	14			
P	0		5110-293-2339				*	AXE: 81349; GGG-A-926, type 1, class 1, design B	ea	1	*	*	*	*	14			
P	0		6250-804-3449	*	*	*	*	BALLAST, LAMP: F/fluorescent; 08808; 89G457D	ea	8	*	*	2	2	36			
P	0		4210-383-7127	*	*	*	*	BRACKET: F/2-1/2 lb fire extinguisher; 33525; PRB-2-1/2	ea	1	*	*	*	*	11			
P	0		4210-268-9729	*	*	*	*	BRACKET: F/5 lb fire extinguisher; 33525; RB-1	ea	1	*	*	*	*	14			
P	0		7920-178-8315	*	*	*	*	BRUSH, DUSTING, BENCH: 80063; SC-C-539469	ea	1	*	*	*	*	14			
P	0		6145-752-2473	*	*	*	*	CABLE, POWER, ELECTRICAL WT-26/U: For power cable assys	ft	115	*	*	*	*				
P	0		6145-283-9475	*	*	*	*	CABLE, POWER, ELECTRICAL: F/line cord; 81349; CO-03HGF(3/14)0560	ft	20	*	*	*	*				
P	0		6145-985-7704	*	*	*	*	CABLE, POWER, ELECTRICAL: F/fan; 81349; CO-02MGF(2/16)0338	ft	10	*	*	*	*				
P	0		6145-889-1136	*	*	*	*	CABLE, TELEPHONE WM-61A/U: F/8 ft handset-headset extension cable	ft	8	*	*	*	*				
P	0		5995-889-1500	*	*	*	*	CABLE ASSEMBLY, POWER, ELECTRICAL CX-7453/U: 100 ft pwr cable assy	ea	1	*	*	*	*				

CS

TM 11-5895-224-15

SOURCE CD	MAINT. CD	REC. CODE	REPAIR PARTS FOR ORGANIZATIONAL MAINTENANCE										UNIT OF ISSUE	(5) QTY INC IN UN PK	(6) QTY INC IN UNIT	(7) 15 DAY ORG. MAINT. ALW.				(8) ILLUSTRATIONS	
			(2) FEDERAL STOCK NUMBER	(3) MODEL					(3) DESCRIPTION	(A) FIGURE NUMBER	(B) ITEM OR SYMBOL NUMBER										
				1	2	3	4	5				6				(A) 5-1	(B) 02-9	(C) 50-12	(D) 51-100-5		
			AN/MSC-32 (continued)																		
P	0		4940-752-2474	*	*	*	*	*			CABLE ASSEMBLY, POWER ELECTRICAL: Line cord; 80063; SM-D-350987	ea	1	*	*	*	*	2			
P	0		5995-889-0803	*	*	*	*	*			CABLE ASSEMBLY, TELEPHONE CX-4760A/U: 15 ft lg	ea	1	*	*	*	*	2			
P	0		5995-681-8440	*	*	*	*	*			CABLE ASSEMBLY, TELEPHONE CX-4566A/U: 250 ft lg	ea	1	*	*	*	*	3			
P	0		5995-752-2566	*	*	*	*	*			CABLE ASSEMBLY, TELEPHONE: F/LS-147C/FI and TA-312/PT; 4 ft lg; 80063; SM-D-383873-GR III	ea	5	*	*	*	2	2	3		
P	0		5995-889-0923	*	*	*	*	*			CABLE ASSEMBLY, TELEPHONE: F/SB-22/PT; 80063; SM-C-353715	ea	1	*	*	*	*	23			
P	0		5995-823-3016	*	*	*	*	*			CABLE ASSEMBLY, TELEPHONE: F/TTY; Black plug; 6 ft lg; 80063; SM-D-384145-GR I	ea	2	*	*	*	*	2	2		
P	0		5995-889-0608	*	*	*	*	*			CABLE ASSEMBLY, TELEPHONE: F/TTY; red plug; 80063 SM-D-384145-GR II	ea	2	*	*	*	*	2	2		
P	0		5940-254-2244	*	*	*	*	*			CAP, ELECTRICAL: F/U-106/U; 80063; SC-C-76202-1	ea	52	*	2	2	3	8, 9			
P	0		5910-713-8313	*				*			CAPACITOR, FIXED, PAPER DIELECTRIC: F/fan; 00656; P150F83	ea	2	*	*	*	*	2	34	C1	
P	0		5910-553-6096	*	*	*	*	*			CAPACITOR, FIXED, PAPER DIELECTRIC: F/fluorescent; 02777; 591B	ea	8	*	*	2	2				
P	0		5925-682-1061	*	*	*	*	*			CIRCUIT BREAKER: 90211; Q0-115	ea	3	*	*	2	2	41		CB1, CB2, CB5	
P	0		5925-523-5764	*	*	*	*	*			CIRCUIT BREAKER: 90211; A0-120	ea	3	*	*	2	2	41		CB3, CB4, CB6	
P	0		5925-682-1071	*	*	*	*	*			CIRCUIT BREAKER: 90211; Q0-250	ea	1	*	*	*	*	41		CB7	
P	0		5340-857-1424	*	*	*	*	*			CLIP, RETAINING: Holds cable in cradle clips; 06229; N-1	ea	39	*	2	2	3				
P	0		5340-857-1424	*	*	*	*	*			CLIP, RETAINING: Holds cable in cradle clips; 06229; N-1	ea	19	*	*	2	2				
P	0		5975-705-5841	*	*	*	*	*			CLIP, RETAINING: Holds cable in cradle clips; 06229; N-3	ea	6	*	*	*	2				
P	0		5975-705-5841	*	*	*	*	*			CLIP, RETAINING: Holds cable in cradle clips; 06229; N-3	ea	9	*	*	2	2				

SOURCE CD (1)	REPAIR PARTS FOR ORGANIZATIONAL MAINTENANCE											UNIT OF ISSUE (4)	(5) QTY INC IN UN PK	(6) QTY INC IN UNIT	(7) 15 DAY ORG. MAINT. ALW.				(8) ILLUSTRATIONS				
	MAINT. CD (2)	REC. CODE (3)	(2) FEDERAL STOCK NUMBER	(3) DESCRIPTION						(A) FIGURE NUMBER	(B) ITEM OR SYMBOL NUMBER												
				MODEL																			
				1	2	3	4	5	6														
P	O		2590-831-6944	*	*	*	*						AN/MSC-32 (continued)	ea		5	*	*	*		2		
P	O	R	6645-800-7094	*									CLOCK, AIRCRAFT, MECHANICAL: 80063; SC-C-539475	ea		1	*	*	*	*		13	
P	O	R	6645-303-4950	*	*	*	*						CLOCK, AIRCRAFT, MECHANICAL: 81349; MIL-C-7939A, type AT-11, AN/5743-2 (Note: When replacing retain mtg bkt for installing new clock.)	ea		1	*	*	*	*		13	
P	O	R	6645-526-4395	*			*						CLOCK, AIRCRAFT, MECHANICAL: 80063; SM-B-472589-5 (Note: When replacing retain mtg bkt for installing new clock.)	ea		1	*	*	*	*		13	
P	O		6605-892-5399	*	*	*	*	*					COMPASS, MAGNETIC: 81349; MIL-C-10436	ea		1	*	*	*	*			
P	O		5935-283-2950	*	*	*	*	*					CONNECTOR, PLUG, ELECTRICAL U-77/U: F/8 ft handset-headset extension cable assy.	ea		1	*	*	*	*			
P	O		5935-283-2884	*	*	*	*	*					CONNECTOR, PLUG, ELECTRICAL U-78/U: F/8 ft handset-headset extension cable assy	ea		1	*	*	*	*			
P	O		5935-045-9830	*	*	*	*	*					CONNECTOR, PLUG, ELECTRICAL U-185B/G: F/26 pr cable assys	ea		3	*	*	*	2	2		
P	O		5935-064-5731	*	*	*	*	*					CONNECTOR, PLUG, ELECTRICAL U-237/G: F/pwr cable assys	ea		3	*	*	*	2	2		
P	O		5935-646-5908	*	*	*	*	*					CONNECTOR, PLUG, ELECTRICAL: 74545; 9754	ea		4	*	*	*	2	2		
P	O		5935-646-5908	*	*	*	*	*						ea		3	*	*	*	2	2		
P	O		5935-192-1294	*	*	*	*	*					CONNECTOR, PLUG, ELECTRICAL: F/SB-22/PT Cable Assy; 81349; MS3108B-28-12P	ea		1	*	*	*	*			
P	O		5935-504-3637	*	*	*	*	*					CONNECTOR, PLUG, ELECTRICAL: 74545; 9755	ea		1	*	*	*	*			
P	O		5935-682-0381	*	*	*	*	*					CONNECTOR, RECEPTACLE, ELECTRICAL U-187/G	ea		2	*	*	*	*		2	
P	O		5935-064-5732	*	*	*	*	*					CONNECTOR, RECEPTACLE, ELECTRICAL U-238/G: Mtd in pwr ent box	ea		2	*	*	*	*		2	8

SOURCE CD	MAINT. CD	REC. CODE	REPAIR PARTS FOR ORGANIZATIONAL MAINTENANCE						(4) UNIT OF ISSUE	(5) QTY INC IN UN PK	(6) QTY INC IN UNIT	(7) 15 DAY ORG. MAINT. ALW.				(8) ILLUSTRATIONS		
			(2) FEDERAL STOCK NUMBER	(3) DESCRIPTION								(A) FIGURE NUMBER	(B) ITEM OR SYMBOL NUMBER					
				MODEL														
			1	2	3	4	5	6			(A) 1-5	(B) 6-20	(C) 21-50	(D) 51-100				
P	O		5935-665-5708	*	*	*	*	*	AN/MSC-32 (continued)	ea	1	*	*	*	*	13		
P	O		5935-259-3313	*	*	*	*	*	CONNECTOR, RECEPTACLE, ELECTRICAL: F/SB-22/PT; 81349; MS3102A-28-12S	ea	2	*	*	*	2	41	J4, J17	
P	O		5935-549-3562	*	*	*	*	*	CONNECTOR, RECEPTACLE, ELECTRICAL: Duplex; 74545;	ea	8	*	*	2	2	41	J3, J5, J6, J7, J14, J15, J16	
P	O		5935-594-3562					*		ea	2	*	*	*	2			
P	O		5935-359-6025	*	*	*	*	*	CONNECTOR, RECEPTACLE, ELECTRICAL: Simplex; 74545; 9210	ea	3	*	*	2	2	41	J8, J9, J11	
P	O		5935-359-6025					*		ea	1	*	*	*	*			
P	O		5935-199-0275	*	*	*	*	*	CONNECTOR, RECEPTACLE, ELECTRICAL: 74545; 9213	ea	4	*	*	2	2	41	J10, J12, J13	
P	O		5935-295-3129					*	CONNECTOR, RECEPTACLE, ELECTRICAL: Duplex; 74545; 5262	ea	10	*	*	2	2			
P	O		5995-752-2516	*	*	*	*	*	CORD ASSEMBLY, ELECTRICAL: 2 ft 6 in lg; black; 80063; SM-D-352593-GR III	ea	3	*	*	2	2	3		
P	O		5995-752-2515	*	*	*	*	*	CORD ASSEMBLY, ELECTRICAL: 2 ft 6 in lg; red; 80063; SM-D-352594-GR III	ea	3	*	*	2	2	3		
P	O		5995-752-2594	*	*	*	*	*	CORD ASSEMBLY, ELECTRICAL: 2 ft 6 in lg; white; 80063; SM-D-352595-GR III	ea	3	*	*	2	2	3		
P	O		5995-752-2593	*	*	*	*	*	CORD ASSEMBLY, ELECTRICAL: 2 ft 6 in lg; green; 80063; SM-D-352596-GR III	ea	4	*	*	2	2	3		
P	O		5995-752-2597	*	*	*	*	*	CORD ASSEMBLY, ELECTRICAL: 2 ft 6 in lg; gray; 80063; SM-D-352597-GR III	ea	1	*	*	*	*	3		
P	O		5410-792-6341	*	*	*	*	*	CURTAIN, BLACKOUT: Left hand; 80063; SM-C-352521-2	ea	1	*	*	*	*			
P	O		5410-792-6339	*	*	*	*	*	CURTAIN, BLACKOUT: Right hand; 80063; SM-C-352521-1	ea	1	*	*	*	*			
P	O		5120-408-1481	*	*	*	*	*	EXTRACTOR, ELECTRON TUBE: F/7 pin; 73917; TP-11-16	ea	1	*	*	*	*	14		
P	O		5120-293-2692	*	*	*	*	*	EXTRACTOR, ELECTRON TUBE: F/9 pin; 73917; TP-13-16	ea	1	*	*	*	*	14		

SOURCE CD (1)	MAINT. CD (2)	REC. CODE (3)	REPAIR PARTS FOR ORGANIZATIONAL MAINTENANCE						(4) UNIT OF ISSUE	(5) QTY INC IN UN PK	(6) QTY INC IN UNIT	(7) 15 DAY ORG. MAINT. ALW.				(8) ILLUSTRATIONS		
			(2) FEDERAL STOCK NUMBER	(3) DESCRIPTION								(A) 1-5	(B) 6-20	(C) 21-50	(D) 51-100	(A) FIGURE NUMBER	(B) ITEM OR SYMBOL NUMBER	
				MODEL														
				1	2	3	4	5										6
							AN/MS-32 (continued)											
P	O		6230-012-4520	*	*	*	FLXTURE, LIGHTING: (Spotlight) 08621; 20463	ea	2	*	*	*	*	16				
P	O		6210-752-2543	*	*	*	FLXTURE, LIGHTING: (Spotlight) 78674; 20447	ea	2	*	*	*	*	16				
P	O		5120-776-9917	*	*	*	GRIP, CABLE JAW: Approx 16 in lg; 95344; EQA-6-8P	ea	13	*	*	2	2	2				
P	O		5120-776-9918	*	*	*	GRIP, CABLE, JAW: Approx 12 in lg; 95344; EQA-26S	ea	12	*	*	2	2	2				
P	O		5120-251-4489	*	*	*	HAMMER, HAND: 79796; 15	ea	1	*	*	*	*	14				
P	O		4140-792-8395	*	*	*	IMPELLER, FAN: 82877; 23396-02	ea	2	*	*	*	*					
P	O		5935-283-1269	*	*	*	JACK, TELEPHONE: 80063; SC-D-19393	ea	7	*	*	*	2	42	J1 thru J7			
P	O		5935-228-4038	*	*	*	JACK, TELEPHONE: 81349; JJ-085	ea	18	*	*	2	2	42	J1 thru J15, J26, J27, J28			
P	O		5935-192-4826	*	*	*	JACK, TELEPHONE: 81349; JJ-086	ea	24	*	*	2	2	42	J1 thru J7, J16 thru J35			
P	O		2540-892-6243	*	*	*	LADDER, VEHICLE, BOARDING MX-3391/G	ea	1	*	*	*	2	15				
P	O		6240-538-8447	*	*	*	LAMP, FLUORESCENT: 08808; F20T12/CW	ea	8	*	2	3	5	41	DS8 thru DS15			
P	O		6240-299-5876	*	*	*	LAMP, GLOW NE-34	ea	1	*	*	*	2	41	DS7			
P	O		6240-179-1814	*	*	*	LAMP, GLOW NE-45	ea	9	*	2	2	3	10, 35				
P	O		6240-155-7786	*	*	*	LAMP, INCANDESCENT: F/Lantern; 08808; PR-2	ea	1	*	*	2	2					
P	O		6240-143-3070	*	*	*	LAMP, INCANDESCENT: 08808; 50W/RS	ea	4	*	2	2	3					
P	O		6210-274-5647	*	*	*	LAMPHOLDER: For night light; f/50 w bulb; 74545; 456	ea	1	*	*	*	*	13				
P	O		6250-109-1091	*	*	*	LAMPHOLDER: 77166; P823J	ea	1	*	*	*	*	41	XDS7			
P	O		6250-752-1233	*	*	*	LAMPHOLDER: 72619; 4-74-6	ea	9	*	*	2	2	41 35	XDS1 thru XDS6 XDS1, XDS2, XDS3			

SOURCE CD (1)	MAINT. CD (2)	REC. CODE (3)	REPAIR PARTS FOR ORGANIZATIONAL MAINTENANCE						(4) UNIT OF ISSUE	(5) QTY INC IN UN PK	(6) QTY INC IN UNIT	(7) 15 DAY ORG. MAINT. ALW.				(8) ILLUSTRATIONS		
			(2) FEDERAL STOCK NUMBER	(3) DESCRIPTION								(A) FIGURE NUMBER	(B) ITEM OR SYMBOL NUMBER					
				MODEL														
				1	2	3	4	5						6				
											(A) 1-5	(B) 0-9	(C) 05-1-2	(D) 5-100				
P	0		6250-299-6093	*	*	*	*	*	AN/MSC-32 (continued)	ea	8	*	*	*	2	41	XDS8 thru XDS15	
P	0		6250-174-4684	*	*	*	*	*	LAMPHOLDER: F/fluorescent; 08808; 78X491	ea	8	*	*	*	2	41	XDS8 thru XDS15	
P	0		6230-729-9614	*	*	*	*	*	LAMPHOLDER: F/fluorescent; incl starter socket; 08808; 78X736	ea	1	*	*	*	2			
P	0		5410-752-2525	*	*	*	*	*	LANTERN, ELECTRIC: 32572; 2106-7	ea	2	*	*	*	*	2		
P	0		6230-615-5384	*	*	*	*	*	LEAD, ELECTRICAL: 80063; SM-B-539592	ea	1	*	*	*	2	2		
P	0		6105-792-8384	*				*	LIGHT, EXTENSION: 81349; W-L-661, type 1, class 1	ea	2	*	*	*	2			
P	0		6105-561-6321	*	*				MOTOR, ALTERNATING CURRENT: 82877; 23396-01	ea	2	*	*	*	2			
P	0		6105-999-4814		*			*	MOTOR, ALTERNATING CURRENT: 16748; A8265M1	ea	1	*	*	*	*			
P	0		5940-223-5293	*	*	*	*	*	MOTOR, ALTERNATING CURRENT: 24453; KH37KG712X	ea	52	*	2	2	3	8, 9		
P	0		8130-656-1090	*	*	*	*	*	POST BINDING U-106/U	ea	2	*	*	*	*			
P	0		5410-793-2021						REEL, CABLE RC-435/U	ea								
P	0		5975-656-5260	*	*	*	*	*	REPAIR KIT, ELECTRONIC EQUIPMENT SHELTER MX-680/G: (Note: To be requisitioned for immediate use only, order direct from depot stock.)	ea	2	*	*	2	2	6		
P	0		6230-474-4497	*	*	*	*	*	ROD, GROUND MX-148/G	ea	1	*	*	*	*	13		
P	0		6210-754-8134	*	*	*	*	*	SHADE, LAMP: 89285; 365P	ea	8	*	*	2	2			
P	0		6250-299-2884	*	*	*	*	*	SHIELD LIGHT: F/fluorescent; 80063; SM-C-349983	ea	8	*	2	2	3			
P	0		5410-792-6336	*	*	*	*	*	STARTER, FLUORESCENT LAMP: 71183; FS-2	ea	6	*	*	2	2	2		
P	0		5930-752-3082	*	*	*	*	*	STRAP ASSEMBLY, TIE DOWN: 98313; FDC-1575101-1	ea	1	*	*	*	*	41	S1	
P	0		5930-615-7896	*	*	*	*	*	SWITCH, SENSITIVE: 91929; BZ-2RQ-181-P4	ea	3	*	*	2	2	41	S1, S2, S3	
P	0		5930-075-7231					*	SWITCH, TOGGLE: 81349; MS25098-22	ea	3	*	*	2	2	41	S1, S2, S3	
P	0							*	SWITCH, TOGGLE: 08808; 5051-1	ea	3	*	*	2	2	41	S1, S2, S3	

SOURCE CD	MAINT. CD	REC. CODE	REPAIR PARTS FOR ORGANIZATIONAL MAINTENANCE						UNIT OF ISSUE	QTY INC IN UN PK	QTY INC IN UNIT	15 DAY ORG. MAINT. ALW.				ILLUSTRATIONS		
			(2) FEDERAL STOCK NUMBER	(3) DESCRIPTION								(A)	(B)	(7)		(A)	(B)	
				MODEL								FIGURE NUMBER	ITEM OR SYMBOL NUMBER	(1)	(2)	(3)	(4)	
				1	2	3	4	5				6			1-5	6-20	21-50	51-100
P	0		5930-548-5150	*	*	*	*		AN/MSC-32 (continued)	ea	2	*	*	*	2	41	S5, S6	
P	0		5930-636-4014	*	*	*	*		SWITCH, TOGGLE: 73586; 3036	ea	4	*	*	2	2	41	S2, S3, S4, S7	
P	0		5930-636-4014				*		SWITCH, TOGGLE: 08808; 5521-1	ea	3	*	*	2	2			
P	0		5410-792-6335	*	*	*	*		TIE DOWN PLATE ASSEMBLY: 98313; FDC-1225M5	ea	6	*	*	*	2			
P	0		5950-705-9105	*	*	*	*		TRANSFORMER, CURRENT: 93993; 3CT-35B	ea	1	*	*	*	*	41	T1	
P	0		6625-883-4272	*	*	*	*		VOLTMETER: 81349; MR36W150ACVVR	ea	1	*	*	*	*	41	M1	

SECTION IV. REPAIR PARTS, DS, GS, AND DEPOT MAINTENANCE

SOURCE CD (A)	(1)			(2)	(3)	(4)	(5)	(6)	(7)						(8)	(9)	(10)													
	MAINT. CD (B)	REC. CODE (C)	FEDERAL STOCK NUMBER						DESCRIPTION	UNIT OF ISSUE	QTY INC IN UN PK	QTY INC IN UNIT	30 DAY MAINT. ALW.						1 YR. ALW. PER 100 EQUIP. CNTGTY PL.	DEPOT MAINT. ALW. PER 100 EQUIP.	(A) FIGURE NUMBER	(B) ITEM OR SYMBOL NUMBER								
													MODEL										DS			GS				
													1	2			3	4					5	6	1-20 (A)	21-50 (B)	51-100 (C)	1-20 (A)	21-50 (B)	51-100 (C)
			5895-021-2090		OPERATIONS CENTRAL AN/MSC-32 (This item is nonexpendable.)  SHELTER, ELECTRICAL EQUIPMENT S-184/MSC-32, S-184A, B, C, D/MSC-32  NOTE: Model column 1 refers to S-184/MSC-32; column 2 refers to S-184A/MSC-32; column 3 refers to S-184B/MSC-32; column 4 refers to S-184C/MSC-32; column 5 refers to S-184D/MSC-32.																									
P	O		6625-892-5315	*	*	*	*	*	AMMETER: 81349; MR36W050SPECR	ea	1	*	*	*	*	*	*	5	5	41	M2									
P	O		4210-727-8111	*	*	*	*	*	AXE, PICKHEAD: 02461; 276	ea	1	*	*	*	*	*	*	5	5	14										
P	O		5110-293-2339					*	AXE: 81349; GGG-A-926, type 1, class 1, design B																					
P	O		6250-804-3449	*	*	*	*	*	BALLAST, LAMP: F/fluorescent; 08808; 89G457D	ea	8	*	2	2	*	2	2	27	15	36										
P	O		4210-383-7127	*	*	*	*	*	BRACKET: F/2-1/2 lb fire extinguisher; 33525; PRB-2-1/2	ea	1	*	*	*	*	*	*	4	5	11										
P	O		4210-268-9729	*	*	*	*	*	BRACKET: F/5 lb fire extinguisher; 33525; RB-1	ea	1	*	*	*	*	*	*	4	5	14										
P	O		7920-178-8315	*	*	*	*	*	BRUSH, DUSTING, BENCH: 80063; SC-C-539469	ea	1	*	*	*	*	*	*	8	3	14										
P	O		6145-752-2473	*	*	*	*	*	CABLE, POWER, ELECTRICAL WT-26/U: For power cable assys	ft	115	*	*	*	*	*	*	406	1150											
P	O		6145-283-9475	*	*	*	*	*	CABLE POWER, ELECTRICAL: F/line cord; 81349; CO-03HGF(3/14)0560	ft	20	*	*	*	*	*	*	83	200											
P	O		6145-985-7704	*	*	*	*	*	CABLE, POWER, ELECTRICAL: F/fan; 81349; CO-02MGF(2/16)0338	ft	10	*	*	*	*	*	*	46	100											



SOURCE CD S	(1) REPAIR PARTS FOR DIRECT SUPPORT, GENERAL SUPPORT, AND DEPOT MAINTENANCE			IND CD	(3) DESCRIPTION	(4) UNIT OF ISSUE	(5) QTY INC IN UN PK	(6) QTY INC IN UNIT	(7) 30 DAY MAINT. ALW.						(8) 1 YR. ALW. PER 100 EQUIP. CNTGCY PL	(9) DEPOT MAINT. ALW. PER 100 EQUIP.	(10) ILLUSTRATIONS							
	MAINT. CD S	REC. CODE C	(2) FEDERAL STOCK NUMBER						(3) MODEL								DS			GS			(A) FIGURE NUMBER	(B) ITEM OR SYMBOL NUMBER
									1	2	3	4	5	6			1-20 S	21-50 S	51-100 S	1-20 S	21-50 S	51-100 S		
P	O		6145-889-1136	*	*	*	*	*	AN/MSC-32 (continued)	ft	8	*	*	*	*	*	40	80						
P	H		6145-577-8480	*	*	*	*	*	CABLE, TELEPHONE WM-61A/U: F/8 ft handset-headset extension cable	ft	265				*	*	*	885	2650					
P	O		5995-889-1500	*	*	*	*	*	CABLE TELEPHONE WM-130/G: F/26 pr cable assys	ft	1	*	*	*	*	*	8	6						
P	O		4940-752-2474	*	*	*	*	*	CABLE ASSEMBLY, POWER, ELECTRICAL CX-7453/U: 100 ft lg pwr cable assy	ea	1	*	*	*	*	*	5	2	2					
P	O		5995-889-0803	*	*	*	*	*	CABLE ASSEMBLY, POWER ELECTRICAL: Line cord; 80063; SM-D-350987	ea	1	*	*	*	*	*	5	2	2					
P	O		5995-681-8440	*	*	*	*	*	CABLE ASSEMBLY, TELEPHONE CX-4760A/U: 15 ft lg	ea	1	*	*	*	*	*	5	2	3					
P	O		5995-752-2566	*	*	*	*	*	CABLE ASSEMBLY, TELEPHONE CX-4566A/U: 250 ft lg	ea	5	*	2	2	*	2	2	27	30	3				
P	O		5995-889-0923	*	*	*	*	*	CABLE ASSEMBLY, TELEPHONE: F/LS-147C/PI and TA-312/PT; 4 ft lg; 80063; SM-D-383873-GR III	ea	1	*	*	*	*	*	8	6	23					
P	O		5995-823-3016	*	*	*	*	*	CABLE ASSEMBLY, TELEPHONE: F/TTY; black plug; 6 ft lg; 80063; SM-D-384145-GR I	ea	2	*	*	2	*	2	2	13	12	2				
P	O		5995-889-0608	*	*	*	*	*	CABLE ASSEMBLY, TELEPHONE: F/TTY; red plug; 80063; SM-D-384145-GR II	ea	2	*	*	2	*	2	2	13	12	2				
P	O		5940-254-2244	*	*	*	*	*	CAP, ELECTRICAL: F/U-106/U; 80063; SC-C-76202-1	ea	52	2	3	5	2	2	2	59	260	8, 9				
P	O		5910-713-8313	*		*			CAPACITOR, FIXED, PAPER DIELECTRIC: F/fan; 00656; P150F83	ea	2	*	*	2	*	2	2	13	12	34	C1			

CS

TM 11-5895-224-15

SOURCE CD (3)	(1)		REPAIR PARTS FOR DIRECT SUPPORT, GENERAL SUPPORT, AND DEPOT MAINTENANCE										(4)	(5)	(6)	(7)						(8)	(9)	(10)					
	MAINT. CD (a)	REC. CODE (c)	(2) FEDERAL STOCK NUMBER	(3) MODEL						(3) DESCRIPTION	UNIT OF ISSUE	QTY INC IN UN PK				QTY INC IN UNIT	DS			GS				1 YR. ALW. PER 100 EQUIP. CNTGCTY P.L.	DEPOT MAINT. ALW. PER 100 EQUIP.	(a) FIGURE NUMBER	(b) ITEM OR SYMBOL NUMBER		
				1	2	3	4	5	6								IND CD	1-20 (a)	21-50 (b)	51-100 (c)	1-20 (a)							21-50 (b)	51-100 (c)
P	O		5910-553-6096	*	*	*	*	*					AN/MSC-32 (continued)	ea	8	2	2	3	2	2	2	40	48						
P	O		5925-682-1061	*	*	*	*	*					CAPACITOR, FIXED, PAPER DIELECTRIC: F/fluorescent; 02777; 591B	ea	3	*	2	2	*	2	2	18	18	41	CB1, CB2, CB5				
P	O		5925-523-5764	*	*	*	*	*					CIRCUIT BREAKER: 90211; Q0-115	ea	3	*	2	2	*	2	2	18	18	41	CB3, CB4, CB6				
P	O		5925-682-1071	*	*	*	*	*					CIRCUIT BREAKER: 90211; Q0-250	ea	1	*	*	*	*	*	*	8	6	41	CB7				
P	O		5340-857-1424	*	*	*	*						CLIP, RETAINING: Holds cable in cradle clips; 06229; N-1	ea	39	2	3	5	2	2	2	59	390						
P	O		5340-857-1424	*	*	*	*						CLIP, RETAINING: Holds cable in cradle clips; 06229; N-3	ea	19	2	2	3	2	2	2	33	190						
P	O		5975-705-5841	*	*	*	*						CLIP, RETAINING: Holds cable in cradle clips; 06229; N-5	ea	6	*	*	2	*	2	2	13	60						
P	O		5975-705-5841	*	*	*	*						CLIP, RETAINING: Holds cable in cradle clips; 06229; N-5	ea	9	*	2	2	*	2	2	18	90						
P	O		2590-831-6944	*	*	*	*						CLIP, RETAINING: Holds cable in cradle clips; 06229; N-5	ea	5	*	*	2	*	2	2	12	50						
P	O	R	6645-800-7094	*									CLOCK, AIRCRAFT, MECHANICAL: 80063; SC-C-539475	ea	1	*	*	*	*	*	*	4	5	13					
P	O	R	6645-303-4950	*	*	*							CLOCK, AIRCRAFT, MECHANICAL: 81349; MIL-C-7939A, type AT-11, AN/5743-2 (Note: When replacing retain mtg bkt for installing new clock.)	ea	1	*	*	*	*	*	*	4	5	13					
P	O	R	6645-526-4395	*			*						CLOCK, AIRCRAFT, MECHANICAL: 80063; SM-B-472589-5 (Note: When replacing retain mtg bkt for installing new clock.)	ea	1	*	*	*	*	*	*	4	5	13					
P	O		6605-892-5399	*	*	*	*						COMPASS, MAGNETIC: 81349; MIL-C-10436	ea	1	*	*	*	*	*	*	4	5						

SOURCE CD	MAINT. CD	REC. CODE	REPAIR PARTS FOR DIRECT SUPPORT, GENERAL SUPPORT, AND DEPOT MAINTENANCE													UNIT OF ISSUE	QTY INC IN UN PK	QTY INC IN UNIT	30 DAY MAINT. ALW.						1 YR. ALW. PER 100 EQUIP. CNTGTY PL	DEPOT MAINT. ALW. PER 100 EQUIP.	ILLUSTRATIONS	
			FEDERAL STOCK NUMBER	MODEL						DESCRIPTION	IND CD	DS			GS				FIGURE NUMBER	ITEM OR SYMBOL NUMBER								
				1	2	3	4	5	6			1-20	21-50	51-100	1-20						21-50	51-100						
				(a)	(b)	(c)	(d)	(e)	(f)			(g)	(h)	(i)	(j)						(k)	(l)						
			AN/MS-32 (continued)																									
P	O		5935-283-2950	*	*	*	*	*	*		CONNECTOR, PLUG, ELECTRICAL U-77/U: F/8 ft handset-headset extension cable assy	ea	1	*	*	*	*	*	*	8	5							
P	O		5935-283-2884	*	*	*	*	*	*		CONNECTOR, PLUG, ELECTRICAL U-78/U: F/8 ft handset-headset extension cable assy	ea	1	*	*	*	*	*	*	8	5							
P	O		5935-045-9830	*	*	*	*	*	*		CONNECTOR, PLUG, ELECTRICAL U-185B/G: F/26 pr cable assys	ea	3	*	2	2	*	2	2	18	15							
P	O		5935-064-5731	*	*	*	*	*	*		CONNECTOR, PLUG, ELECTRICAL U-237/G: F/pwr cable assys	ea	3	*	2	2	*	2	2	18	15							
P	O		5935-646-5908	*	*	*	*	*	*		CONNECTOR, PLUG, ELECTRICAL: 74545; 9754	ea	4	*	2	2	*	2	2	19	20							
P	O		5935-646-5908	*	*	*	*	*	*		CONNECTOR, PLUG, ELECTRICAL: 74545; 9754	ea	3	*	2	2	*	2	2	18	15							
P	O		5935-192-1294	*	*	*	*	*	*		CONNECTOR, PLUG, ELECTRICAL: F/SB-22/PT cable assy; 81349; MS3108B-28-12P	ea	1	*	*	*	*	*	*	8	5							
P	O		5935-504-3637	*	*	*	*	*	*		CONNECTOR, PLUG, ELECTRICAL: 74545; 9755	ea	1	*	*	*	*	*	*	8	5							
P	O		5935-682-0381	*	*	*	*	*	*		CONNECTOR, RECEPTACLE, ELECTRICAL U-187/G	ea	2	*	*	2	*	2	2	13	12							
P	O		5935-064-5732	*	*	*	*	*	*		CONNECTOR, RECEPTACLE, ELECTRICAL U-238/G: Mtd in pwr ent box	ea	2	*	*	2	*	2	2	13	12	8						
P	O		5935-665-5708	*	*	*	*	*	*		CONNECTOR, RECEPTACLE, ELECTRICAL F/SB-22/PT; 81349; MS3102A-28-12S	ea	1	*	*	*	*	*	*	8	5	13						
P	O		5935-259-3313	*	*	*	*	*	*		CONNECTOR, RECEPTACLE, ELECTRICAL 74545; 7210B	ea	2	*	*	2	*	2	2	13	12	41	J4, J17					
P	O		5935-549-3562	*	*	*	*	*	*		CONNECTOR, RECEPTACLE, ELECTRICAL Duplex; 74545; 9200	ea	8	2	2	3	2	2	2	40	48	41	J3, J5, J6, J7, J14, J15, J16					
P	O		5935-549-3562	*	*	*	*	*	*		CONNECTOR, RECEPTACLE, ELECTRICAL Duplex; 74545; 9200	ea	2	*	*	2	*	2	2	13	12	41	J3, J5, J6, J7, J14, J15, J16					

SOURCE CD (1)	(I)		REPAIR PARTS FOR DIRECT SUPPORT, GENERAL SUPPORT, AND DEPOT MAINTENANCE										(4) UNIT OF ISSUE	(5) QTY INC IN UN PK	(6) QTY INC IN UNIT	(7) 30 DAY MAINT. ALW.						(8) 1 YR. ALW. PER 100 EQUIP. CNTGTY PLI		(9) DEPOT MAINT. ALW. PER 100 EQUIP.		(10) ILLUSTRATIONS	
	MAINT. CD (2)	REC. CODE (3)	(2) FEDERAL STOCK NUMBER	(3) MODEL						(3) DESCRIPTION	DS					GS			FIGURE NUMBER (A)	ITEM OR SYMBOL NUMBER (B)							
				1	2	3	4	5	6		IND CD	1-20 (A)				21-50 (B)	51-100 (C)	0-1 (A)			05-12 (B)	51-100 (C)					
																							ILLUSTRATIONS				
P	O		5935-359-6025	*	*	*	*						AN/MSC-32 (continued)	ea	3	*	2	2	*	2	2	18	18	41	J8, J9, J11		
P	O		5935-359-6025	*	*	*	*						CONNECTOR, RECEPTACLE, ELECTRICAL Simplex; 74545; 9210	ea	1	*	*	*	*	*	*	4	6	41	J8, J9, J11		
P	O		5935-199-0275	*	*	*	*						CONNECTOR, RECEPTACLE, ELECTRICAL 74545; 9213	ea	4	*	2	2	*	2	2	19	24	41	J10, J12, J13		
P	O		5935-295-3129	*	*	*	*						CONNECTOR, RECEPTACLE, ELECTRICAL Duplex; 74545; 5262	ea	10	2	2	3	2	2	2	46	60				
P	O		5995-752-2516	*	*	*	*	*					CORD ASSEMBLY, ELECTRICAL: 2 ft 6 in lg; black; 80063; SM-D-352593-GR III	ea	3	*	2	2	*	2	2	18	18	3			
P	O		5995-752-2515	*	*	*	*	*					CORD ASSEMBLY, ELECTRICAL: 2 ft 6 in lg; red; 80063; SM-D-352594-GR III	ea	3	*	2	2	*	2	2	18	18	3			
P	O		5995-752-2594	*	*	*	*	*					CORD ASSEMBLY, ELECTRICAL: 2 ft 6 in lg; white; 80063; SM-D-352595-GR III	ea	3	*	2	2	*	2	2	18	18	3			
P	O		5995-752-2593	*	*	*	*	*					CORD ASSEMBLY, ELECTRICAL: 2 ft 6 in lg; green; 80063; SM-D-352596-GR III	ea	4	*	2	2	*	2	2	19	24	3			
P	O		5995-752-2597	*	*	*	*	*					CORD ASSEMBLY, ELECTRICAL: 2 ft 6 in lg; gray; 80063; SM-D-352597-GR III	ea	1	*	*	*	*	*	*	4	6	3			
P	O		5410-792-6341	*	*	*	*	*					CURTAIN, BLACKOUT: Left hand; 80063; SM-C-352521-2	ea	1	*	*	*	*	*	*	4	3				
P	O		5410-792-6339	*	*	*	*	*					CURTAIN, BLACKOUT: Right hand; 80063; SM-C-352521-1	ea	1	*	*	*	*	*	*	4	3				
P	O		5120-408-1481	*	*	*	*	*					EXTRACTOR, ELECTRON TUBE: F/7 pin; 73917; TP-11-16	ea	1	*	*	*	*	*	*	4	5	14			

SOURCE CD	(1)			REPAIR PARTS FOR DIRECT SUPPORT, GENERAL SUPPORT, AND DEPOT MAINTENANCE												(4)	(5)	(6)	(7)						(8)		(9)		(10)	
	MAINT. CD	REC. CODE		(2) FEDERAL STOCK NUMBER	(3) MODEL						(3) DESCRIPTION	UNIT OF ISSUE	QTY INC IN UN PK	QTY INC IN UNIT	30 DAY MAINT. ALW.				1 YR. ALW. PER 100 EQUIP.	DEPOT MAINT. ALW. PER 100 EQUIP.	FIGURE NUMBER	ITEM OR SYMBOL NUMBER								
					IND CD										DS								GS							
					1	2	3	4	5	6													(A)	(B)	(C)	(A)	(B)	(C)		
P	0			5120-293-2692	*	*	*	*	*				AN/MSC-32 (continued)	ea		1	*	*	*	*	*	*	4	5	14					
P	0			6230-012-4520	*	*	*	*	*				EXTRACTOR, ELECTRON TUBE: F/9 pin; 73917; TP-13-16	ea		2	*	*	*	*	*	*	10	4	16					
P	0			6210-752-2543					*				FIXTURE, LIGHTING: (Spotlight) 08621; 20463	ea		2	*	*	*	*	*	*	10	4	16					
P	0			5120-776-9917	*	*	*	*	*				FIXTURE, LIGHTING: (Spotlight) 78674; 20447	ea		13	2	2	3	2	2	2	40	130	2					
P	0			5120-776-9918	*	*	*	*	*				GRIP, CABLE JAW: Approx 16 in lg; 95344; EQA-6-8P	ea		12	2	2	3	2	2	2	40	120	2					
P	0			5120-251-4489	*	*	*	*	*				GRIP, CABLE JAW: Approx 12 in lg; 95344; EQA-26S	ea		1	*	*	*	*	*	*	5	5	14					
P	0			4140-792-8395	*			*					HAMMER, HAND: 79796; 15	ea		2	*	*	*	*	*	*	5	6						
P	0			5935-263-1269	*	*	*	*	*				IMPELLER, FAN: 82877; 23396-02	ea		7	*	*	2	*	2	2	15	35	42		J1 thru J7			
P	0			5935-228-4038	*	*	*	*	*				JACK, TELEPHONE: 80063; SC-D-19393	ea		18	2	2	3	2	2	2	33	90	42		J1 thru J15, J26, J27, J28			
P	0			5935-192-4826	*	*	*	*	*				JACK, TELEPHONE: 81349; JJ-086	ea		24	2	2	3	2	2	2	40	120	42		J1 thru J7, J16 thru J35			
P	0			2540-892-6243	*	*	*	*	*				LADDER, VEHICLE, BOARDING MX-3391/G	ea		1	*	*	2	*	2	2	12	10	15					
P	0			6240-538-8447	*	*	*	*	*				LAMP, FLUORESCENT: 08808; F20T12/CW	ea		8	2	4	8	2	2	2	101	400	41		DS8 thru DS15			
P	0			6240-299-5876	*	*	*	*	*				LAMP, GLOW NE-34	ea		1	*	*	2	*	2	2	12	50	41		DS7			
P	0			6240-179-1814	*	*	*	*	*				LAMP, GLOW NE-45	ea		9	2	3	5	2	2	2	59	450	10, 35					
P	0			6240-155-7786	*	*	*	*	*				LAMP, INCANDESCENT: F/lantern; 08808; PR-2	ea		1	*	2	2	*	2	2	19	50						

SOURCE CD (1)	MAINT. CD (2)	REC. CODE (3)	REPAIR PARTS FOR DIRECT SUPPORT, GENERAL SUPPORT, AND DEPOT MAINTENANCE										(4) UNIT OF ISSUE	(5) QTY INC IN UN PK	(6) QTY INC IN UNIT	(7) 30 DAY MAINT. ALW.						(8) 1 YR. ALW. PER 100 EQUIP. CNT/GCY PL	(9) DEPOT MAINT ALW. PER 100 EQUIP.	(10) ILLUSTRATIONS	
			(2) FEDERAL STOCK NUMBER	(3) MODEL						(3) DESCRIPTION	DS					GS			(A) FIGURE NUMBER	(B) ITEM OR SYMBOL NUMBER					
				1	2	3	4	5	6		IND CD	(A)				(B)	(C)	(A)			(B)			(C)	
																									1-20
			AK/MSC-32 (continued)																						
P	O		6243-143-3070	*	*	*	*	*	*	*			ea	4	2	3	5	2	2	2	59	200			
P	O		6210-874-5647	*	*	*	*	*	*	*			ea	1	*	*	*	*	*	*	4	5	13		
P	O		6250-109-1091	*	*	*	*	*	*	*			ea	1	*	*	*	*	*	*	4	5	41	XDS7	
P	O		6250-792-1233	*	*	*	*	*	*	*			ea	9	*	2	2	*	2	2	19	45	41	XDS1 thru XDS6 XDS1, XDS2, XDS3	
P	O		6250-899-6093	*	*	*	*	*	*	*			ea	8	*	*	2	*	2	2	16	40	41	XDS8 thru XDS15	
P	O		6250-174-4684	*	*	*	*	*	*	*			ea	8	*	*	2	*	2	2	16	40	41	XDS8 thru XDS15	
P	O		6230-729-9614	*	*	*	*	*	*	*			ea	1	*	*	2	*	2	2	12	10			
P	O		5410-752-2525	*	*	*	*	*	*	*			ea	2	*	*	*	*	*	*	10	20	2		
P	O		6230-615-5384	*	*	*	*	*	*	*			ea	1	*	*	2	*	2	2	12	10	2		
P	H		5410-973-2936										ea												
P	F		5965-752-6011	*	*	*	*	*	*	*			ea	1	*	*	*	*	*	*	8	5			
P	O		6105-792-8384	*			*						ea	2	*	*	2	*	2	2	13	6			
P	O		6105-561-6321	*	*								ea	2	*	*	2	*	2	2	13	6			

(1)		REPAIR PARTS FOR DIRECT SUPPORT, GENERAL SUPPORT, AND DEPOT MAINTENANCE											(10)										
SOURCE CD (A)	MAINT. CD (B)	REC. CODE (C)	(2) FEDERAL STOCK NUMBER	(3) MODEL						(3) DESCRIPTION	(4) UNIT OF ISSUE	(5) QTY INC IN UN PK	(6) QTY INC IN UNIT	(7) 30 DAY MAINT. ALW.						(8) 1 YR. ALW. PER 100 EQUIP. CNTGTY PL.	(9) DEPOT MAINT. ALW. PER 100 EQUIP.	(A) FIGURE NUMBER	(B) ITEM OR SYMBOL NUMBER
				MODEL										DS			GS						
				1	2	3	4	5	6					IND CD	(A) 1-20	(B) 21-50	(C) 51-100	(A) 1-20	(B) 21-50			(C) 51-100	
P	O		6105-999-4814					*		AN/MSC-32 (continued)	ea	1	*	*	*	*	*	8	3				
P	O		5940-223-5293	*	*	*	*	*		MOTOR, ALTERNATING CURRENT: 24453; KH37KG712X	ea	52	2	3	6	2	2	2	71	260	8, 9		
P	O		8130-656-1090	*	*	*	*	*		POST BINDING U-106/U	ea	2	*	*	*	*	*	10	4				
P	F		5410-771-3354							REPAIR KIT, ELECTRONIC EQUIPMENT SHELTER MK-681/G: Note to be requisitioned for immediate use only, order direct from depot stock.	ea												
P	O		5975-656-5260	*	*	*	*	*		REEL, CABLE RC-435/U	ea	2	*	2	2	*	2	2	19	30	6		
P	O		6230-474-4497	*	*	*	*	*		ROD, GROUND MX-148/G	ea	1	*	*	*	*	*	5	5	13			
P	O		6210-754-8134	*	*	*	*	*		SHADE, LAMP: 89285; 365P	ea	8	*	2	2	*	2	2	27	40			
P	O		6250-299-2884	*	*	*	*	*		SHIELD LIGHT: F/fluorescent; 80063; SM-C-349983	ea	8	2	3	5	2	2	2	59	80			
P	O		5410-792-6336	*	*	*	*	*		STARTER, FLUORESCENT LAMP: 71183; FS-2	ea	6	*	2	2	*	2	2	27	60	2		
P	O		5930-752-3082	*	*	*	*	*		STRAP ASSEMBLY, TIE DOWN: 98313; FDC-1575101-1	ea	1	*	*	2	*	*	8	5	41	S1		
P	O		5930-615-7896	*	*	*	*	*		SWITCH, SENSITIVE: 91929; EZ-2RQ-181-P4	ea	3	2	2	2	*	2	2	18	15	41	S1, S2, S3	
P	O		5930-075-7231					*		SWITCH, TOGGLE: 81349; MS25098-22	ea	3	2	2	2	*	2	2	18	15	41	S1, S2, S3	
P	O		5930-548-5150	*	*	*	*	*		SWITCH, TOGGLE: 08808; 5051-1	ea	2	*	2	2	*	2	2	13	10	41	S5, S6	
P	O		5930-636-4014	*	*	*	*	*		SWITCH, TOGGLE: 73586; 3036	ea	4	2	2	2	*	2	2	18	20	41	S2, S3, S4, S7	
P	O		5930-636-4014					*		SWITCH, TOGGLE: 08808; 5521-1	ea	3	2	2	2	*	2	2	16	15	41	S2, S3, S4, S7	

SOURCE CD (1)	MAINT. CD (2)	REC. CODE (3)	REPAIR PARTS FOR DIRECT SUPPORT, GENERAL SUPPORT, AND DEPOT MAINTENANCE										(4)	(5)	(6)	(7)						(8)	(9)	(10)					
			(2) FEDERAL STOCK NUMBER	(3) MODEL						(3) DESCRIPTION	UNIT OF ISSUE	QTY INC IN UN PK				QTY INC IN UNIT	DS			GS				YR. ALW. PER 100 EQUIP. CNTGTY PL.	DEPOT MAINT. ALW. PER 100 EQUIP.	(A) FIGURE NUMBER	(B) ITEM OR SYMBOL NUMBER		
				1	2	3	4	5	6								IND CD	(A)	(B)	(C)	(A)							(B)	(C)
P	0		5410-792-6335	*	*	*	*	*	*			AN/MS-32 (continued)	ea		6	*	2	2	*	2	2	13	30						
P	0		5950-705-9105	*	*	*	*	*	*			TRANSFORMER, CURRENT: 93993; 3CT-35B	ea		1	*	*	2	*	*	*	8	3	41	T1				
P	0		6625-883-4272	*	*	*	*	*	*			VOLTMETER: 81349; MR36W150ACVVR	ea		1	*	*	*	*	*	*	5	5	41	M1				



SECTION V. FEDERAL STOCK NUMBER INDEX

INDEX — FEDERAL STOCK NUMBER CROSS REFERENCE TO FIGURE AND ITEM NUMBER OR REFERENCE SYMBOL					
STOCK NO.	FIGURE NO.	ITEM NO. REF. SYMBOL	STOCK NO.	FIGURE NO.	ITEM NO. REF. SYMBOL
5910-713-8313	34	C1			
5925-523-5764	41	CB3, CB4, CB6			
5925-682-1061	41	CB1, CB2, CB5			
5925-682-1071	41	CB7			
5930-075-7231	41	S1, S2, S3			
5930-548-5150	41	S5, S6			
5930-615-7896	41	S1, S2, S3			
5930-636-4014	41	S2, S3, S4, S7			
5930-752-3082	41	S1			
5935-192-4826	42	J1 thru J7 J16 thru J35			
5935-199-0275	41	J10, J12, J13			
5935-228-4038	42	J1 thru J15 J26, J27, J28			
5935-259-3313	41	J4, J17			
5935-283-1269	42	J1 thru J7			
5935-359-6025	41	J8, J9, J11			
5935-549-3562	41	J3, J5, J6, J7, J14, J15, J16			
5950-705-9105	41	T1			
6240-299-5876	41	DS7			
6240-538-8447	41	DS8 thru DS15			
6250-109-1091	41	XDS7			
6250-174-4684	41	XDS8 thru XDS15			
6250-299-6093	41	XDS8 thru XDS15			
6250-752-1233	35 41	XDS1 thru XDS3 XDS1 thru XDS6			
6625-883-4272	41	M1			
6625-892-5315	41	M2			

By Order of the Secretary of the Army:

HAROLD K. JOHNSON  
General, United States Army,  
Chief of Staff.

Official:

KENNETH G. WICKHAM,  
Major General, United States Army,  
The Adjutant General.

Distribution:

Active Army:

USASA (2)	USAES (2)	USARMIS (2)
CNGB (1)	USA Tng Cens (2)	Units org under fol TOE:
OCC-E (7)	WRAMC (1)	(2 copies each)
Dir of Trans (1)	Army Pic Cen (2)	11-45
CofEngrs (1)	USACDCEC (10)	11-46
TSG (1)	Instls (2) except	11-57
CofSptS (1)	Ft Hancock (4)	11-85
USAARENBD (2)	Ft Gordon (10)	11-86
USACDC Agcys (1)	Ft Huachuca (13)	11-87
USAMC (5)	WSMR (5)	11-97
USCONARC (5)	Ft Carson (25)	11-98
ARADCOM (5)	Ft Knox (12)	11-116
ARADCOM Rgn (2)	Gen Dep (2)	11-117
OS Maj Comd (4)	Sig Sec Gen Dep (5)	11-127
LOGCOMD (2)	Sig Dep (12)	11-155
USAMICOM (4)	A Dep (2) except	11-157
USASTRATCOM (4)	LBAD (14)	11-158
USAESC (70)	SAAD (30)	11-225
MDW (1)	TOAD (14)	11-226
Armies (2) except	LEAD (7)	11-247
Seventh (5)	NAAD (5)	11-327
Corps (2)	SVAD (5)	11-357
USAC (3)	ATAD (10)	11-500 (AA-AC)
Svc Colleges (2)	Sig FLDMS (2)	11-587
USASESS (5)	AMS (1)	11-592
USAADS (2)	USAERDAA (2)	11-597
USAAMS (2)	USAERDAW (13)	31-105
USAARMS (2)	USACRREL (2)	
USAIS (2)	MAAG (2)	

NG: State AG (3); units—same as Active Army except allowance is one copy.

USAR: None.

For explanation of abbreviations used, see AR 320-50.

Change

No. 6

HEADQUARTERS

DEPARTMENT OF THE ARMY

Washington, D. C., 30 September 1969

**Operator's, Organizational, DS, GS, and Depot Maintenance Manual  
Including Repair Parts and Special Tools Lists  
OPERATIONS CENTRAL AN/MSC-32**

TM 11-5895-224-15, 15 May 1961, is changed as follows:

The title of this manual is changed as shown above.

**NOTE**

The parenthetical reference to a previous change (example: page 1 of C 5) indicates that pertinent material was published in that change.

Page 3 (page 1 of C 5). Make the following changes:  
Paragraph 1.1. Delete and substitute:

**1.1. Indexes of Publications**

a. DA Pam 310-4. Refer to the latest issue of DA Pam 310-4 to determine whether there are new editions, changes, or additional publications pertaining to the equipment.

b. DA Pam 310-7. Refer to DA Pam 310-7 to

determine whether there are modification work orders (MWO's) pertaining to the equipment.

Paragraph 2. Delete subparagraph *d* and substitute:

*d. Reporting of Equipment Publication Improvements.* The reporting of errors, omissions, and recommendations for improving this publication by the individual user is encouraged. Reports should be submitted on DA Form 2028 (Recommended Changes to Publications) and forwarded direct to Commanding General, U. S. Army Electronics Command, ATTN: AMSEL-ME-NMP-AD, Fort Monmouth, N. J., 07703 Page 58, appendix I (page 3 of C 5). Delete appendix 1 and substitute.

## APPENDIX I REFERENCES

The following references are applicable for the operator and repairman of Operations Central AN/MSC-32:

DA Pam 310-4	Index of Technical Manuals, Technical Bulletins, Supply Manuals (types 7, 8, and 9), Supply Bulletins, and Lubrication Orders.
DA Pam 310-7	U. S. Army Equipment Index of Modification Work Orders.
SB 11-6	Dry Battery Supply Data.
SB 11-573	Painting and Preservation Supplies Available for Field Use for Electronics Command Equipment.

SM SIG 7 & 8 TA-125/GT	Terminal Box TA-125/GT.
TB 746-10	Field Instructions for Painting and Preserving Electronics Command Equipment,
TB SIG 354	Maintenance and Repair Procedures for S-141/G-, S-144/G-, S-280/G-, and S-318/G- Type Shelters.
TM 9-213	Painting Instructions for Field Use.
TM 11-2138	Terminal Box TA-125/GT; Telephone Repeating Coil Assembly TA-145/GT; Maintenance Kit MX-842/GT; and Switchboard Signal TA-123/GT.
TM 11-5410-206-12P	Operator and Organizational Maintenance Repair Parts and Special Tools List and Maintenance Allocation Chart: Shelter, Electrical Equipment S-141/G.
TM 11-5410-206-35P	DS, GS, and Depot Maintenance Repair Parts and Special Tool Lists: Shelter, Electrical Equipment S-141/G.
TM 11-5805-201-12	Organizational Maintenance Manual: Telephone Set TA-312/PT.
TM 11-5805-201-20P	Organizational Maintenance Repair Parts and Special Tool Lists: Telephone Set TA-312/PT.
TM 11-5805-201-35	DS, GS, and Depot Maintenance Manual Including Repair Parts and Special Tool Lists: Telephone Set TA-312/PT.
TM 11-5805-201-35P	Field and Depot Maintenance Repair Parts and Special Tool Lists: Telephone Set TA-312/PT.
TM 11-5805-246-10	Operator's Manual: Terminal, Telegraph TH-5/TG.
TM 11-5805-246-20	Organizational Maintenance Manual: Terminal, Telegraph TH-5/TG.
TM 11-5805-246-20P	Organizational Maintenance Repair Parts and Special Tools Lists: Terminal, Telegraph TH-5/TG and TH-5A/TG.
TM 11-5805-246-35	DS, GS, and Depot Maintenance Manual: Terminal, Telegraph TH-5/TG.
TM 11-5805-246-35P	DS, GS, and Depot Maintenance Repair Parts and Special Tool Lists: Terminals, Telegraph TH-5/TG and TH-5A/TG.
TM 11-5805-262-12	Operator's and Organizational Maintenance Manual: Switchboards, Telephone, Manual SB-22/PT and SB-22A/PT.
TM 11-5805-262-20P	Organizational Maintenance Repair Parts and Special Tool Lists: Switchboards, Telephone, Manual SB-22/PT and SB-22A/PT.
TM 11-5805-262-35	DS, GS, and Depot Maintenance Manual: Switchboards, Telephone, Manual SB-22/PT and SB-22A/PT.
TM 11-5805-262-35P	DS, GS, and Depot Maintenance Repair Parts and Special Tool Lists: Switchboards, Telephone, Manual SB-22/PT and SB-22A/PT.
TM 11-5815-206-ESC	Equipment Serviceability Criteria: Teletypewriter Set AN/PGC-1 and Teletypewriters TT-4A/TG, TT-4B/TG, TT-4C/TG, and TT-335/TG.
TM 11-5815-206-12	Organizational Maintenance Manual: Teletypewriter Set AN/PGC-1 and Teletypewriters TT-4A/TG, TT-4B/TG, TT-4C/TG, TT-335/TG, and TT-537/G.

**TM 11-5815-206-20P** Organizational Maintenance Repair Parts and Special Tool Lists: Teletypewriter Set AN/PGC-1 and Teletypewriters TT-4A/TG, TT-4B/TG, TT-4C/TG and TT-335/TG.

**TM 11-5815-206-35** DS, GS, and Depot Maintenance Manual: Teletypewriter Set AN/PGC-1 and Teletypewriters TT-4A/TG, TT-4B/TG, TT-4C/TG, TT-335/TG, and TT-537/G.

**TM 11-5815-206-35P/1** DS, GS, and Depot Maintenance Repair Parts and Special Tool Lists: Teletypewriter Set AN/PGC-1 Including Teletypewriters TT-4A/TG, TT-4B/TG, TT-4C/TG, and TT-335/TG.

**TM 11-5815-206-35P/2** DS, GS, and Depot Maintenance Repair Parts and Special Tool Lists: Teletypewriter Set AN/PGC-1 Including Teletypewriters TT-4A/TG, TT-4B/TG, TT-4C/TG, and TT-335/TG.

**TM 11-5815-238-12** Organizational Maintenance Manual Including Repair Parts and Special Tools List: Teletypewriter Sets AN/GGC-3 and AN/GGC-3A and Teletypewriter Reperforator - Transmitters TT-76/GGC, TT-76A/GGC, TT-76B/GGC, and TT-76C/GGC.

**TM 11-5815-238-35** DS, GS, and Depot Maintenance Manual: Teletypewriter Sets AN/GGC-3 and AN/GGC-3A and Teletypewriter Reperforator-Transmitters TT-76/GGC, TT-76A/GGC, TT-76B/GGC, and TT-76C/GGC.

**TM 11-5815-238-35P** DS, GS, and Depot Maintenance Repair Parts and Special Tool Lists: Teletypewriter Sets AN/GGC-3 and AN/GGC-3A, Reperforator - Transmitters, Teletypewriter TT-76/GGC, TT-76A/GGC, TT-76B/GGC, and TT-76C/GGC.

**TM 11-5830-221-12** Operator's and Organizational Maintenance Manual: Intercommunication Stations LS-147A/FI, LS-147B/FI, LS-147C/FI, and LS-147D/FI.

**TM 11-5830-221-20P** Organizational Maintenance Repair Parts and Special Tool Lists: Intercommunication Stations LS-147A/FI, LS-147B/FI, LS-147C/FI, and LS-147D/FI

**TM 11-5830-221-35** Field and Depot Maintenance Manual: Intercommunication Stations LS-147A/FI, LS-147B/FI, LS-147C/FI, and LS-147D/FI.

**TM 11-5830-221-35P** Field and Depot Maintenance Repair Parts and Special Tool Lists: Intercommunication Stations LS-147A/FI, LS-147B/FI, LS-147C/FI, and LS-147D/FI.

**TM 11-5965-224-15P** Operator, Organizational, Field and Depot Maintenance Repair Parts and Special Lists and Maintenance Allocation Chart: Handsets H-60/PT and H-165/U.

**TM 11-5965-206-15P** Operator, Organizational, Field and Depot Maintenance Repair Parts and Special Tool Lists: Headset-Microphone H-91/U, H-91A/U; Headset-Headset H-144/U, H-144A/U, H-144B/U, H-144C/U, and Headset-Microphone H-210/G.

**TM 11-5965-271-50** Depot Maintenance Manual: Handsets TS-9-(\*), TS-10-(\*), TS-11-(\*), TS-12-F, TS-13-(\*), TS-14-(\*), TS-15-(\*), H-22-B/U, H-23-(\*)/U, and H-60/PT.

**TM 11-6110-201-15P** Operator, Organizational, DS, GS, and Depot Maintenance Repair Parts and Special Tool Lists: Distribution Boxes J-1077/U and J-1077A/U.

Page 69, appendix III, section II. Make the following changes:

(Page 12 of C 5). Federal stock number column, change "5805-257-3602" to 5807-715-6171. Description column, change "SWITCHBOARD, TELEPHONE, MANUAL SB-22/PT (Less cover)" to SWITCHBOARD, TELEPHONE MANUAL SB-22A/PT (Less cover).

(Page 15 of C 5). Federal stock number "5960-762-0185". Delete item in its entirety.

(Page 17 of C 5). Federal stock number "5807-715-6175". Rec. code column, add: R.

Page 71, appendix IV, section I, paragraph A4-5 (page 21 of C 5).

Make the following changes:

Code no., change "77166" to 81091.

Code no., change "78674" to 08621.

Code no., change "89285" to 06857. Manufacturer, change "Benjamin Electric Mfg. Co." to Benjamin Thomas Industries, Inc.

Section III. Reference Federal stock number. Change Federal supply code for the following items.

Page	Federal stock number	Item	Description column
29 of C 5	6210-752-2543	FIXTURE, LIGHTING	Delete: 78674
			Substitute: 08621
	6250-109-1091	LAMPHOLDER	Delete: 77166
			Substitute: 81091
39 of C 5	6230-474-4497	SHADE, LAMP	Delete: 89285
			Substitute: 06859

Section IV. Reference Federal stock number. Change Federal supply code for the following items.

Page	Federal stock number	Item	Description column
37 of C 5	6210-752-2543	FIXTURE, LIGHTING	Delete: 78674
			Substitute: 08621
38 of C 5	6250-109-1091	LAMPHOLDER	Delete: 77166
			Substitute: 81091
39 of C 5	6230-474-4497	SHADE, LAMP	Delete: 89285
			Substitute: 06859

**By Order of the Secretary of the Army**

**Official:**

**KENNETH G. WICKHAM**  
**Major General, United States Army**  
**The Adjutant General**

**W. C. WESTMORELAND**  
**General, United States Army**  
**Chief of Staff**

**Distribution:**

**Active Army:**

USASA (2)	Army Dep (2) except
CNGB (1)	LBAD (14)
ACSC-E (2)	SAAD (30)
Dir of Trans (1)	TOAD (14)
Co of Engrs (1)	LEAD (7)
TSG (1)	SHAD (3)
C of Spt S (1)	NAAD (5)
USAARENBD (2)	SVAD (5)
USACDC Agcy (1)	CHAD (3)
USAMC (1)	ATAD (40)
USCONARC (5)	GENDEPS (2)
ARADCOM (5)	Sig Sec GENDEPS (5)
ARADCOM Rgn (2)	Sig Dep (12)
OS Maj Comd (4)	Sig FLDMS (2)
LOGCOMD (2) except	TOPOCOM (1)
1st LOGCOMD (10)	USAERDAA (2)
8th LOGCOMD (10)	USAERDAW (13)
USAMICOM (4)	USACRREL (2)
USATECOM (2)	MAAG (2)
USASTRATCOM (4)	USARMIS (2)
USAESC (70)	USMACV (50)
MDW (1)	Units org under fol TOE
Armies (2) except	(2 cys each unit):
Seventh USA (5)	11-45
Corps (2)	11-46
1st Cal Div (5)	11-57
Svc Colleges (2)	11-85
USASCS (5)	11-86
USASESS (5)	11-87
USAADS (2)	11-97
USA FA Sch (2)	11-98
USAARMS (2)	11-116
USAIS (2)	11-117
USAES (2)	11-127
USAINTS (3)	11-155
USATC Armor (2)	11-157
USATC Inf (2)	11-158
USASTC (2)	11-225
WRAMC (1)	11-226
Army Pic Cen (2)	11-247
USACDCEC (10)	11-327
Instl (2) except	11-357
Fort Gordon (16)	11-500 (AA-AC)
Fort Huachuca (10)	11-587
Fort Carson (25)	11-592
Fort Knox (12)	11-597
WSMR (5)	31-105

NG: State AG (3): units — same as Active Army except allowance is one copy each unit.

USAR: None.

For explanation of abbreviations used, see AR 320-50.



CHANGE }  
No. 5 }

HEADQUARTERS  
DEPARTMENT OF THE ARMY  
WASHINGTON, D. C., 30 August 1967

**Organizational, DS, GS, and Depot Maintenance Manual**

**Including Repair Parts List**

**OPERATIONS CENTRAL AN/MS-32**

TM 11-5895-224-15, 15 May 1961, is changed as follows:  
Title is changed as shown above.

*Note.* The parenthetical reference to previous changes (example: "page 1 of C 3") indicates that pertinent material was published in that change.

Page 3. Add the following "Note" below the title of chapter 1:

*Note.* Shelters, Electrical Equipment S-184A/MS-32, S-184B/MS-32, S-184C/MS-32, and S-184D/MS-32 are similar to Shelter, Electrical Equipment S-184/MS-32. Information in this manual applies to all shelter facilities unless otherwise specified.

Paragraph 1 (page 1 of C 3). Delete paragraph 1.1 and substitute:

**1.1 Index of Publications**

Refer to the latest issue of DA Pam 310-4 to determine whether there are new editions, changes, or additional publications pertaining to the equipment.

Page 3, paragraph 2 (changed by C 4, 14 Jan 65). Delete paragraph 2 and substitute:

**2. Forms and Records**

*a. Reports of Maintenance and Unsatisfactory Equipment.* Use equipment forms and rec-

ords in accordance with instructions in TM 38-750.

*b. Report of Packaging and Handling Deficiencies.* Fill out and forward DD Form 6 (Report of Packaging and Handling Deficiencies) as prescribed in AR 700-58 (Army), NAVSUP Publication 378 (Navy), AFR 71-4 (Air Force), and MCO P4610-5 (Marine Corps).

*c. Discrepancy in Shipment Report (DISREP) (SF361).* Fill out and forward Discrepancy in Shipment Report (DISREP) (SF361) as prescribed in AR 55-38 (Army), NAVSUP Pub 459 (Navy), AFM 75-34 (Air Force), and MCO P4610.19 (Marine Corps).

*d. Reporting of Equipment Manual Improvements.* DA Form 2028 (Recommended Changes to DA Publications) will be used for reporting discrepancies and recommendations for improving this equipment publication. The form will be completed by the individual using the manual and forwarded direct to Commanding General, U.S. Army Electronics Command, ATTN: AMSEL-ME-NMP-AD, Fort Monmouth, N. J., 07703.

\*This change supersedes C 4, 14 January 1965, and TM 11-5895-224-25P, 5 January 1965.

Page 58, appendix I (changed by C 4, 14 Jan 65). Delete and substitute:

## APPENDIX I

### REFERENCES

The following references are applicable for the operator and repairman of Operations Central AN/MSC-32:

AR 810-1	Index of Administrative Publications.
AR 750-10	Maintenance of Supplies and Equipment Material Readiness (Serviceability of Unit Equipment).
DA Pam 310-4	Index of Technical Manuals, Technical Bulletins, Supply Manuals (Types 7, 8, and 9), Supply Bulletins, and Lubrication Orders.
DA Pam 310-7	Modification Work Orders.
MWO 11-5815-282-30/1	Modification of Teletypewriter Reperforator Transmitter TT-76/GGC, TT-76A/GGC, TT-76B/GGC, TT-178/FG, TT-178A/FG, TT-179/FG, TT-179A/FG, and TT-181/FG to Permit External Control of the Clutch Magnet of Communication Security Equipment.
SB 11-6	Dry Battery Supply Data.
SB 11-513	Multimeter AN/URM-105.
SB 11-540	Multimeter AN/URM-105 and TS-352/U.
TB SIG 354	Maintenance and Repair Procedures for Lightweight Field and Mobile Shelters of Aluminum Stressed Skin Foam-Core Construction (Covering S-141/G and S-144/G Type Shelters).
TM 9-213	Painting Instructions for Field Use.
TM 11-5410-206-12P	Operator and Organizational Maintenance Repair Parts and Special Tools List and Maintenance Allocation Chart: Shelter, Electrical Equipment S-141/G.
TM 11-5805-201-12	Organizational Maintenance Manual: Telephone Set TA-312/PT.
TM 11-5805-201-20P	Organizational Maintenance Repair Parts and Special Tool Lists: Telephone Set TA-312/PT.
TM 5805-201-35P	Field and Depot Maintenance Repair Parts and Special Tool Lists: Telephone Set TA-312/PT.
TM 11-5805-246-10	Operator's Manual: Terminal, Telegraph TH-5/TG.
TM 11-5805-246-20	Organizational Maintenance Manual: Terminal, Telegraph TH-5/TG.
TM 5805-246-20P	Organizational Maintenance Repair Parts and Special Tools Lists: Terminal, Telegraph TH-5/TG and TH-5A/TG.
TM 11-5805-246-35	DS, GS, and Depot Maintenance Manual: Terminal, Telegraph TH-5/TG.
TM 11-5805-246-35P	DS, GS, and Depot Maintenance Repair Parts and Special Tool Lists: Terminals, Telegraph TH-5/TG and TH-5A/TG.
TM 11-5805-257-12P	Operator and Organizational Maintenance Repair Parts and Special Tools List and Maintenance Allocation Chart: Generators, Ringing, Hand G-42/PT and G-42A/PT.

- TM 11-5805-262-12 Operator's and Organizational Maintenance Manual: Switchboards, Telephone, Manual SB-22/PT and SB-22A/PT.
- TM 11-5805-262-20P Organizational Maintenance Repair Parts and Special Tool Lists: Switchboards, Telephone, Manual SB-22/PT and SB-22A/PT.
- TM 11-5805-262-35 Field and Depot Maintenance Manual: Switchboards, Telephone, Manual SB-22/PT and SB-22A/PT.
- TM 11-5805-262-35P DS, GS, and Depot Maintenance Repair Parts and Special Tool Lists: Switchboards, Telephone, Manual SB-22/PT and SB-22A/PT.
- TM 11-5815-206-ESC Operator and Organizational Maintenance Manual: Teletypewriter Set AN/PGC-1 and Teletypewriters TT-4A/TG, TT-4B/TG, TT-4C/TG, and TT-335/TG.
- TM 11-5815-206-20P Organizational Maintenance Repair Parts and Special Tool Lists: Teletypewriter Set AN/PGC-1 and Teletypewriters TT-4A/TG, TT-4B/TG, TT-4C/TG, and TT-335/TG.
- TM 11-5815-206-35 Field and Depot Maintenance Manual: Teletypewriter Set AN/PGC-1 and Teletypewriters TT-4A/TG, TT-4B/TG, TT-4C/TG, and TT-335/TG.
- TM 11-5815-206-35P/1 DS, GS, and Depot Maintenance Repair Parts and Special Tool Lists: Teletypewriter Set AN/PGC-1 Including Teletypewriters TT-4A/TG, TT-4B/TG, TT-4C/TG, and TT-335/TG.
- TM 11-5815-206-35P/2 DS, GS, and Depot Maintenance Repair Parts and Special Tool Lists: Teletypewriter Set AN/PGC-1 Including Teletypewriters TT-4A/TG, TT-4B/TG, TT-4C/TG, and TT-335/TG.
- TM 11-5815-238-12 Organizational Maintenance Manual Including Repair Parts and Special Tools List: Teletypewriter Sets AN/GGC-3 and AN/GGC-3A and Teletypewriter Reperforator-Transmitters TT-76/GGC, TT-76A/GGC, TT-76B/GGC, and TT-76C/GGC.
- TM 11-5815-238-35 DS, GS, and Depot Maintenance Manual: Teletypewriter Sets AN/GGC-3 and AN/GGC-3A and Teletypewriter Reperforator-Transmitters TT-76/GGC, TT-76A/GGC, TT-76B/GGC, and TT-76C/GGC.
- TM 11-5815-238-35P DS, GD, and Depot Maintenance Repair Parts and Special Tool Lists: Teletypewriter Sets AN/GGC-3 and AN/GGC-3A, Reperforator-Transmitters, Teletypewriter TT-76/GGC, TT-76A/GGC, TT-76B/GGC, and TT-76C/GGC.
- TM 11-5830-221-12 Operator's and Organizational Maintenance Manual: Intercommunication Stations LS-147A/FI, LS-147B/FI, LS-147C/FI, and LS-147D/FI.
- TM 11-5830-221-20P Organizational Maintenance Repair Parts and Special Tool Lists: Intercommunication Stations LS-147A/FI, LS-147B/FI, LS-147C/FI, and LS-147D/FI.
- TM 11-5830-221-35 Field and Depot Maintenance Manual: Intercommunication Stations LS-147A/FI, LS-147B/FI, LS-147C/FI, and LS-147D/FI.
- TM 11-5830-221-35P Field and Depot Maintenance Repair Parts and Special Tool Lists: Intercommunication Stations LS-147A/FI, LS-147B/FI, LS-147C/FI, and LS-147D/FI.
- TM 11-5895-223-15 Organizational, DS, GS, and Depot Maintenance Manual: Operations Center, Communications AN/MS-31 Including Repair Parts List.
- TM 11-5965-207-12P Operator's, Organizational Maintenance Repair Parts and Special Tools List and Maintenance Allocation Chart: Handset-Headsets H-81/U and H-81A/U.
- TM 5965-207-35P Field and Depot Maintenance Repair Parts and Special Tools List: Handset-Headsets H-81/U and H-81A/U.

- TM 11-5965-224-15P Operator, Organizational, Field and Depot Maintenance Repair Parts and Special Tool Lists and Maintenance Allocation Chart: Handsets H-60/PT and H-165/U.
- TM 11-5965-271-50 Depot Maintenance Manual: Handsets TS-9-(\*), TS-10-(\*), TS-11-(\*), TS-12-F, TS-13-(\*), TS-14-(\*), TS-15-(\*), H-22-B/U, H-23-(\*)/U, and H-60/PT.
- TM 11-6110-201-15P Operator, Organizational, Field and Depot Maintenance Repair Parts and Special Tool Lists and Maintenance Allocation Chart: Distribution Boxes J-1077/U and J-1077A/U.
- TM 11-6625-203-12 Operator and Organizational Maintenance: Multimeter AN/URM-105 Including Multimeter ME-77/U.
- TM 11-6625-203-20P Organizational Maintenance Repair Parts and Special Tools List: Multimeter AN/URM-105.
- TM 11-6625-203-35 Field and Depot Maintenance Manual: Multimeter AN/URM-105 Including Multimeter ME-77/U.
- TM 11-6625-203-45P Field (Fourth Echelon) and Depot Maintenance Repair Parts and Special Tool Lists: Multimeter AN/URM-105.
- TM 88-750 Army Equipment Record Procedures.

Page 62, appendix II (as changed by C 4, 14 Jan 65). Delete and substitute:

## APPENDIX II

### MAINTENANCE ALLOCATION

---

#### Section I. INTRODUCTION

##### A2-1. General

This appendix provides a summary of the maintenance operations covered in the equipment literature for Operations Central AN/ MSC-32. It authorizes categories of maintenance for specific maintenance functions on repairable items and components and the tools and equipment required to perform each function. This appendix may be used as an aid in planning maintenance operations.

##### A2-2. Explanation of Format for Maintenance Allocation Chart

*a. Group Number.* Group numbers correspond to the reference designation prefix assigned in accordance with ASA Y32.16, Electrical and Electronics Reference Designations. They indicate the relation of listed items to the next higher assembly.

*b. Component Assembly Nomenclature.* This column lists the item names of component units, assemblies, subassemblies, and modules on which maintenance is authorized.

*c. Maintenance Function.* This column indicates the maintenance category at which performance of the specific maintenance function is authorized. Authorization to perform a function at any category also includes authorization to perform that function at higher categories. The codes used represent the various maintenance categories as follows:

Code	Maintenance category
C.....	Operator/Crew
O.....	Organizational Maintenance
F.....	Direct Support Maintenance
H.....	General Support Maintenance
D.....	Depot Maintenance

*d. Tools and Equipment.* The numbers appearing in this column refer to specific tools and equipment which are identified by these numbers in section III.

*e. Remarks.* Self explanatory.

##### A2-3. Explanation of Format for Tool and Test Equipment Requirements

The columns in the tool and test equipment requirements chart are as follows:

*a. Tools and Equipment.* The numbers in this column coincide with the numbers used in the tools and equipment column of the MAC. The numbers indicate the applicable tool for the maintenance function.

*b. Maintenance Category.* The codes in this column indicate the maintenance category normally allocated the facility.

*c. Nomenclature.* This column lists tools, test, and maintenance equipment required to perform the maintenance functions.

*d. Federal Stock Number.* This column lists the Federal stock number.

*e. Tool Number.* Not used.

SECTION II. MAINTENANCE ALLOCATION CHART

GROUP NUMBER	COMPONENT ASSEMBLY NOMENCLATURE	MAINTENANCE FUNCTIONS										TOOLS AND EQUIPMENT	REMARKS				
		INSPECT	TEST	SERVICE	ADJUST	ALIGN	CALIBRATE	INSTALL	REPLACE	REPAIR	OVERHAUL			REBUILD			
	OPERATIONS CENTRAL AG/MSC-34	C		C											3	Preventive maintenance	
			C	C											6	Operational Test in accordance with component maintenance allocation (MAC)	
			F												6		
					O										6	Adjust in accordance with component MAC	
					H										6	Repair in accordance with component MAC	
										C					6		
										O					5,6		
										F					4,5,6		
										H					4,5,6	By component	
											H				2,4,5,6	Shelter facility only	
1A	SHELTER, ELECTRICAL EQUIPMENT S-184, 184A, B, C, D/MSC-32	C		C											3	Preventive maintenance	
				O											1	Continuity of light, power and signal circuits	
				H											1,2	All tests	
															3	Light, power and signal circuits	
										O					6		
										F					6	By component MAC	
1A1	BLOWER, EXHAUST		O												3	Operational	
															3	Replace motor and impeller	
1A2	FIRE EXTINGUISHER															#	Corps of engineers

TM 11-5895-224-15

C5

MAINTENANCE ALLOCATION CHART

GROUP NUMBER	COMPONENT ASSEMBLY NOMENCLATURE	MAINTENANCE FUNCTIONS										TOOLS AND EQUIPMENT	REMARKS		
		INSPECT	TEST	SERVICE	ADJUST	ALIGN	CALIBRATE	INSTALL	REPLACE	REPAIR	OVERHAUL			REBUILD	
	AN/MS-32 (continued)														
1A3	HEATER, ELECTRICAL 1500 WATTS									#					USAMEC responsibility
1A4	CABLE ASSEMBLIES 26 PAIR		F							F			3		Replace connector
1A5	DISTRIBUTION BOX J-1077A/U									#					TM 11-6110-201-15P
1A6	INTERCOMMUNICATION STATION LS-147C/FI									#					TM 11-5830-221-12
1A7	SHELTER, ELECTRICAL EQUIPMENT S-141/G									#					TM 11-5410-206-12P
1B	SWITCHBOARD, TELEPHONE SB-22A/PT									#					TM 11-5805-262-12
1C	TELEPHONE SET TA-312/PT									#					TM 11-5805-201-12
1D	TELETYPEWRITER SET AN/GGC-3A; TELETYPEWRITER REPERFORATOR TT-76, A, B/GGC									#					TM 11-5815-238-12
1E	TELETYPEWRITER SET AN/PGC-1; TELETYPEWRITER TT-4 A, B, C/TG									#					TM 11-5815-206-12
1F	TERMINAL, TELEGRAPH TH-5/TG									#					TM 11-5805-246-20
	#Indicates that maintenance guidance will be found in documents referenced in remarks column.														

## SECTION III. TOOL AND TEST EQUIPMENT REQUIREMENTS

10

TOOLS AND EQUIPMENT	MAINTENANCE CATEGORY	NOMENCLATURE	FEDERAL STOCK NUMBER	TOOL NUMBER
		AN/MSC-32 (continued)		
1	O,F,H,D	MULTIMETER TS-352/U (TO BE REPLACED BY AN/USM-223)	6625-581-2036	
2	H,D	OHMMETER ZM-21A/U	6625-246-5880	
3	O,F	TOOL EQUIPMENT TE-123	5180-408-1881	
4	H,D	TOOL KIT, ELECTRONIC EQUIPMENT SHELTER TK-144/G	5180-987-4369	
5	F,H,D	TOOL KIT, GENERAL MECHANIC	5180-754-0641	
6	O,F,H,D	TOOLS AND TEST EQUIPMENT ASSOCIATED COMPONENTS. F END ITEM		
		NOTE: DEPOT MAY USE ANY OTHER EQUIPMENT REQUIRED TO OVERHAUL OR REBUILD THIS EQUIPMENT		

TM 11-5895-224-15

CS



Page 68, appendix III (as changed by C 4, 14 Jan 65). Delete and substitute:

## APPENDIX III

### BASIC ISSUE ITEMS

#### Section I. INTRODUCTION

#### A3-1. General

This appendix lists items for Operations Central AN/MS-32, the component items comprising it, and the items which accompany it, or are required for installation, operation, or operator's maintenance.

#### A3-2. Explanation of Columns

An explanation of the columns in section II is given below.

##### a. Source, Maintenance, and Recoverability Codes, Column 1.

- (1) *Source code, column 1a.* Not used.
- (2) *Maintenance code, column 1b.* Not used.
- (3) *Recoverability code, column 1c.* The information in this column indicates whether unserviceable items should be returned for recovery or salvage. Recoverability code and its explanation is as follows:

*Note.* When no code is indicated in the recoverability column, the part will be considered expendable.

Code	Explanation
R.....	Applies to repair parts and assemblies that are economically repairable at DSU and GSU activities and are normally furnished by supply on an exchange basis.

*b. Federal Stock Number, Column 2.* The Federal stock number for the item is indicated in this column.

*c. Description, Column 3.* The Federal item name, a five-digit manufacturer's code, a part

number, and when required, the model designator (\*), which indicates different models of the end equipment, are included in this column.

*d. Unit of Issue, Column 4.* The unit used as a basis of issue (e.g. ea, pr, ft, yd, etc) is noted in this column.

*e. Quantity Incorporated in Unit pack, Column 5.* Not used.

*f. Quantity Incorporated in Unit, Column 6.* The total quantity of the item used in the equipment is given in this column.

*g. Quantity Authorized, Column 7.* The total quantity of an item required to be on hand and necessary for the operation and maintenance of the equipment is given in this column.

*h. Illustration, Column 8.*

(1) *Figure number, column 8a.* The number of the illustration in which the item is shown is indicated in this column.

(2) *Item or symbol number, column 8b.* Not used.

#### A3-3. Batteries

Dry batteries shown are used with the equipment but are not considered part of the equipment. They will not be preshipped automatically but are to be requisitioned in quantities necessary for the particular organization, in accordance with SB 11-6.

## SECTION II. BASIC ISSUE ITEMS LIST

SOURCE CD (1)	MAINT. CD (2)	REC. CODE (3)	(2) FEDERAL STOCK NUMBER						(3) DESCRIPTION	(4) UNIT OF ISSUE	(5) QTY INC IN UNIT PACK	(6) QTY INC IN UNIT	(7) QTY AUTH	(8) ILLUSTRATIONS	
														MODEL	
			1	2	3	4	5	6							
			5895-021-2090						OPERATIONS CENTRAL AN/MSC-32 (This item is nonexpendable.)						
									TECHNICAL MANUAL TM 11-5895-224-15	ea		1			
									Requisition through pinpoint account number if assigned; otherwise through nearest Adjutant General facility.						
									NOTE: A quantity of 1 technical manual is packed with each equipment. Where a valid need exists, additional copies may be requisitioned and kept on hand.						
									TECHNICAL BULLETIN TB SIG-354	ea		1			
									Requisition through pinpoint account number if assigned; otherwise through nearest Adjutant General facility.						
									NOTE: For maintainable equipments listed below, only one each technical manual is authorized.						
	R		5965-682-2769						HANDSET-HEADSET H-144/U	ea	1	1			
	R		5815-503-2760						REPERFORATOR-TRANSMITTER, TELETYPEWRITER TT-76/GGC	ea	1	1			
									OR						
	R		5815-553-6061						REPERFORATOR-TRANSMITTER TT-76A, B, C/GGC	ea	1	1			
	R		5410-752-9621						SHELTER, ELECTRICAL EQUIPMENT S-184/MSC-32; S-184A, B, C, D/MSC-32 (S-141/G Shelter modified)	ea	1	1			
	R		5805-257-3602						SWITCHBOARD, TELEPHONE, MANUAL SB-22/PT (Less cover)	ea	1	1			
	R		5805-543-0012						TELEPHONE SET TA-312/PT	ea	4	4			
	R		5815-198-4438						TELETYPEWRITER TT-4A/TG	ea	2	2			
	R		5805-246-8734						TERMINAL, TELEGRAPH TH-5/TG	ea	3	3			

SOURCE CD (1)	MAINT. CD (2)	REC. CODE (3)	BASIC ISSUE ITEMS LIST						(4) UNIT OF ISSUE	(5) QTY INC IN UNIT PACK	(6) QTY INC IN UNIT	(7) QTY AUTH	(8) ILLUSTRATIONS		
			(2) FEDERAL STOCK NUMBER	(3) DESCRIPTION									(a) FIGURE NUMBER	(a) ITEM OR SYMBOL NUMBER	
				MODEL											
1	2	3	4	5	6										
							AN/MSC-32 (continued)								
							SHELTER, ELECTRICAL EQUIPMENT S-184/MSC, S-184A, B, C, D/MSC-32 (S-141/G SHELTER MODIFIED)								
							NOTE: Model column 1 refers to S-184/MSC-32; column 2 refers to S-184A/MSC-32; column 3 refers to S-184B/MSC-32; column 4 refers to S-184C/MSC-32; column 5 refers to S-184D/MSC-32								
							4210-727-8111 * * * * AXE, PICKHEAD: 02461; 276	ea		1	1	14			
							5110-293-2339 * * * * AXE: 81349; GGG-A-926, type 1, class 1, design B	ea		1	1	14			
							7520-753-4807 * * * * BASKET, WASTEPAPER: 85838; 36	ea		3	3	12			
							7502-292-9493 * * * * BASKET, WASTEPAPER: 81349; RR-B-181, type II, style B, gray	ea		3	3				
							6135-120-1020 * * * * BATTERY, DRY BA-30	ea			4				
							7920-178-8315 * * * * BRUSH DUSTING, BENCH: 80063; SC-C-539469	ea		1	1	14			
							5995-823-2715 * * * * CABLE ASSEMBLY AND REEL: Consists of CX-4566A/G, 250 ft lg, and Reel RC-435/U	ea		1	1	3			
							5410-752-2435 * * * * CABLE ASSEMBLY AND REEL: Consists of CX-7453/U, 100 ft lg, and Reel RC-435/U	ea		1	1	3			
							5995-752-2548 * * * * CABLE ASSEMBLY, POWER ELECTRICAL CX-7705/U: 15 ft lg power stub	ea		1	1	2			
							4940-752-2474 * * * * CABLE ASSEMBLY, POWER ELECTRICAL: Line cord; 80063; SM-D-350987	ea		1	1	2			
							5995-823-2620 * * * * CABLE ASSEMBLY, SPECIAL PURPOSE: F/headset; 80063; SM-C-382135	ea		1	1	2			
							5995-889-0803 * * * * CABLE ASSEMBLY, TELEPHONE CX-4760A/U: 15 ft lg	ea		1	1	2			

SOURCE CD (1)	MAINT. CD (2)	REC. CODE (3)	BASIC ISSUE ITEMS LIST						(4) UNIT OF ISSUE	(5) QTY INC IN UNIT PACK	(6) QTY INC IN UNIT	(7) QTY AUTH	(8) ILLUSTRATIONS		
			(2) FEDERAL STOCK NUMBER	(3) DESCRIPTION									(A) FIGURE NUMBER	(B) ITEM OR SYMBOL NUMBER	
				MODEL											
1	2	3	4	5	6										
							AN/MSC-32 (continued)								
			*	*	*	*	CABLE ASSEMBLY, TELEPHONE: F/LS-147C/FI and TA-312/PT; 4 ft lg; 80063; SM-D-383873-GR III	ea		5	5	3			
			*	*	*	*	CABLE ASSEMBLY, TELEPHONE: F/SB-22/PT; 80063; SM-C-353715	ea		1	1	23			
			*	*	*	*	CABLE ASSEMBLY, TELEPHONE: F/TTY; black plug; 6 ft lg; 80063; SM-D-384145-GR I	ea		2	2	2			
			*	*	*	*	CABLE ASSEMBLY, TELEPHONE: F/TTY; ref plug; 6 ft lg; 80063; SM-D-384145-GR II	ea		2	2	2			
			*	*	*	*	CHAIR, FOLDING: 80063; SC-D0539471	ea		3	3	15			
			*	*	*	*	CHAIR, ROTARY (NOTE: When replacing chair remove and retain mounting bracket for installation on new chair.)	ea		1	1	12			
	R		*				CLOCK, AIRCRAFT, MECHANICAL: 80063; SC-C-539475	ea		1	1	13			
	R		*	*	*	*	CLOCK, AIRCRAFT, MECHANICAL: 81349; MIL-C-7939A, type AT-11, AN/5743-2 (NOTE: When replacing retain mtg bkt for installing new clock.)	ea		1	1	13			
	R		*			*	CLOCK, AIRCRAFT MECHANICAL: 80063; SM-B-472589-5 (NOTE: When replacing retain mtg bkt for installing new clock.)	ea		1	1	13			
			*	*	*	*	COMPASS, MAGNETIC: 81349; MIL-C-10436	ea		1	1				
			*	*	*	*	CORD ASSEMBLY, ELECTRICAL: 2 ft 6 in lg; black; 80063; SM-D-352593-GR III	ea		3	3	3			
			*	*	*	*	CORD ASSEMBLY, ELECTRICAL: 2 ft 6 in lg; red; 80063; SM-D-352594-GR III	ea		3	3	3			
			*	*	*	*	CORD ASSEMBLY, ELECTRICAL: 2 ft 6 in lg; white; 80063; SM-D-352595-GR III	ea		3	3	3			
			*	*	*	*	CORD ASSEMBLY, ELECTRICAL: 2 ft 6 in lg; green; 80063; SM-D-352596-GR III	ea		4	4	3			

SOURCE CD (1)	(2)			BASIC ISSUE ITEMS LIST						(4)	(5)	(6)	(7)	(8)					
	MAINT. CD (2)	REC. CODE (3)	(2) FEDERAL STOCK NUMBER	(3) DESCRIPTION										UNIT OF ISSUE	QTY INC IN UNIT PACK	QTY INC IN UNIT	QTY AUTH	ILLUSTRATIONS	
				MODEL														(A) FIGURE NUMBER	(B) ITEM OR SYMBOL NUMBER
			1	2	3	4	5	6											
									AN/MSC-32 (continued)										
			5995-752-2597	*	*	*	*	*	CORD ASSEMBLY, ELECTRICAL: 2 ft 6 inlg; gray; 80063; SM-D-597-GR III	ea		1	1	3					
			7210-753-3043	*	*	*	*	*	CUSHION, CHAIR: 80063; SM-C-350214	ea		3	3	7					
		R	6110-649-8146	*	*	*	*	*	DISTRIBUTION BOX J-1077A/U	ea		1	1	13					
			5960-262-0185	*	*	*	*	*	ELECTRON TUBE: 81349; 5726/6AL5W	ea		6	2						
			5960-262-0152	*	*	*	*	*	ELECTRON TUBE: 81349; 6AU6WA	ea		1	1						
			5960-188-0880	*	*	*	*	*	ELECTRON TUBE: 81349; 6X4W	ea		1	1						
			5960-669-6861	*	*	*	*	*	ELECTRON TUBE: 81349; 6005/6AQ5W	ea		1	1						
			5960-166-7663	*	*	*	*	*	ELECTRON TUBE: 81349; 12AU7	ea		1	2						
			5960-166-7664	*	*	*	*	*	ELECTRON TUBE: 81349; 12AX7	ea		1	1						
		R	4210-383-7128	*	*	*	*	*	EXTINGUISHER, FIRE: 2-1/2 lb; 33525; 2-1/2T2	ea		1	1	11					
		R	4120-383-7129	*	*	*	*	*	EXTINGUISHER, FIRE: 5 lb; 80063; SC-D-539482	ea		1	1	14					
			5120-408-1481	*	*	*	*	*	EXTRACTOR, ELECTRON TUBE: F/7 pin; 73917; TP-11-16	ea		1	1	14					
			5120-293-2692	*	*	*	*	*	EXTRACTOR, ELECTRON TUBE: F/9 pin; 73917; TP-13-16	ea		1	1	14					
			6545-822-3166	*	*	*	*	*	FIRST AID KIT: 80063; SM-C-349935	ea		1	1	14					
			6545-922-1200	*	*	*	*	*	FIRST AID KIT	ea		1	1	14					
			6645-663-9032					*	FIRST AID KIT: 81349; GG-K-392, type 2, size 1	ea		1	1						
			5920-356-2188	*	*	*	*	*	FUSE, CARTRIDGE: 81349; FO2GR125A	ea		1	5						
			5920-636-3047	*	*	*	*	*	FUSE, CARTRIDGE: 1 amp; 75915; 313.001	ea		1	5						
			5920-280-9328	*	*	*	*	*	FUSE, CARTRIDGE: 81349; FO2D1R50B	ea		1	5						
			5920-224-5269	*	*	*	*	*	FUSE, CARTRIDGE: 1.6 amp; 75915; 313.016	ea		1	5						

(1)			BASIC ISSUE ITEMS LIST						(4)	(5)	(6)	(7)	(8)		
SOURCE CD (a)	MAINT. CD (b)	REC. CODE (c)	(2) FEDERAL STOCK NUMBER	(3) DESCRIPTION						UNIT OF ISSUE	QTY INC IN UNIT PACK	QTY INC IN UNIT	QTY AUTH	ILLUSTRATIONS	
				MODEL										(a) FIGURE NUMBER	(b) ITEM OR SYMBOL NUMBER
				1	2	3	4	5	6						
			5920-581-4144	*	*	*	*	*	AN/MSC-32 (continued)	ea					
			5120-776-9917	*	*	*	*	*	FUSE, CARTRIDGE: 2 amp; 71400; MDX-2 (2 mtd in equip)	ea		2	7		
			5120-776-9918	*	*	*	*	*	GRIP, CABLE, JAW: approx 16 in lg; 95344; EQA-6-8P	ea		13	13	2	
			5120-776-9918	*	*	*	*	*	GRIP, CABLE, JAW: approx 12 in lg; 95344; EQA-26S	ea		12	12	2	
			5120-251-4489	*	*	*	*	*	HAMMER, HAND: 79796; 15	ea		1	1	14	
			5120-793-2027	*	*	*	*	*	HANDLE, HAMMER: 79796; AW30	ea		1	1	14	
	R		4520-224-7909	*	*	*	*	*	HEATER SPACE, ELECTRICAL: 80063; SC-D-539485	ea		2	2	12	
	R		5830-752-5357	*	*	*	*	*	INTERCOMMUNICATION STATION LS-147C/FI	ea		1	1	13	
			2540-892-6243	*	*	*	*	*	LADDER, BOARDING, VEHICLE MX-3391/G	ea		1	1	15	
			6240-538-8447	*	*	*	*	*	LAMP, FLUORESCENT: 08808; F20T12CW	ea		8	2	4	
			6240-249-5876	*	*	*	*	*	LAMP, GLOW NE-34	ea		1	1	4	
			6240-179-1814	*	*	*	*	*	LAMP, GLOW NE-45	ea		6	2	4	
			6240-223-9100	*	*	*	*	*	LAMP, GLOW NE-51	ea		3	1		
			6240-155-8706	*	*	*	*	*	LAMP, INCANDESCENT: 81349; M815571-2, type TB-14	ea		1	1		
			6240-892-6102	*	*	*	*	*	LAMP, INCANDESCENT: 08808; 1007/5DC	ea		1	1		
			6240-143-3084	*	*	*	*	*	LAMP, INCANDESCENT: 08808; 15T7/DC (mtd in equip)	ea		1	1		
			6240-143-3060	*	*	*	*	*	LAMP, INCANDESCENT: 08808; 686DC-120	ea		1	1		
			6240-196-4501	*	*	*	*	*	LAMP, INCANDESCENT: 80063; SC-D-84552-6	ea		1	1		
			6240-143-3070	*	*	*	*	*	LAMP, INCANDESCENT: 08808; 50W/RS	ea		3	3	4	
			6240-155-7786	*	*	*	*	*	LAMP, INCANDESCENT: 08808; PR-2 (Mtd in lantern)	ea		1	1	4	
			6230-729-9614	*	*	*	*	*	LANTERN, ELECTRICAL: 32572; 2106-7	ea		1	1	14	

SOURCE CD (1)	MAINT. CD (2)	REC. CODE (3)	BASIC ISSUE ITEMS LIST						(4) UNIT OF ISSUE	(5) QTY INC IN UNIT PACK	(6) QTY INC IN UNIT	(7) QTY AUTH	(8) ILLUSTRATIONS		
			(2) FEDERAL STOCK NUMBER	(3) DESCRIPTION									(A) FIGURE NUMBER	(B) ITEM OR SYMBOL NUMBER	
				MODEL											
1	2	3	4	5	6										
							AN/MS-C-32 (continued)								
							5410-752-2525 * * * * *	ea		2	2	2			
							6230-615-5384 * * * * *	ea		1	1	2			
							7510-240-1526 * * * * *	ea		4	4	11			
							7510-436-5210 * * * * *	ea		4	4	11			
							7510-275-7212 * * * * *	ea		4	4	11			
							7510-174-3205 * * * * *	ea		4	4	11			
							7510-264-4612 * * * * *	ea		4	4	11			
							5120-293-3603 * * * * *	ea		1	1				
							5975-224-5260 * * * * *	ea		2	2	14			
							5120-752-9675 * * * * *	ea		1	1				
							6130-076-3545 * * * * *	ea		12	1				
							6130-076-3546 * * * * *	ea		6	1				
							7520-162-6178 * * * * *	ea		1	1	14			
							6210-752-8134 * * * * *	ea		8	8	7			
							6250-299-2884 * * * * *	ea		8	6	4			
							5410-792-6336 * * * * *	ea		6	6	2			
							5210-221-1882 * * * * *	ea		1	1				
		R					5805-503-3337 * * * * *	ea		12	2				
							5805-715-6175 * * * * *	ea		1	1				

(1)			BASIC ISSUE ITEMS LIST						(4)	(5)	(6)	(7)	(8)		
SOURCE CD (a)	MAINT. CD (b)	REC. CODE (c)	(2) FEDERAL STOCK NUMBER	(3) DESCRIPTION						UNIT OF ISSUE	QTY INC IN UNIT PACK	QTY INC IN UNIT	QTY AUTH	ILLUSTRATIONS	
				MODEL										(A) FIGURE NUMBER	(B) ITEM OR SYMBOL NUMBER
				1	2	3	4	5	6						
			7530-223-7966	*	*	*	*	*		AN/MSC-32 (continued)					
										ACCESSORIES, TOOLS, AND TEST EQUIPMENT					
			7511-511-6690	*	*	*	*	*		PAPER, RECORDING, TELETYPEWRITER: 81349; UU-P-547C, type 1, class 1	ea		1	1	
			7530-634-6237	*	*	*	*	*		RIBBON, PRINTING, TELETYPEWRITER: 81349; DDD-R-311D, type 1, grade A, class 1	ea		1	1	
										TAPE TELETYPEWRITER: 31349; UU-T-120	ea		1	4	
										NO BASIC ISSUE ITEMS ARE MOUNDED IN OR ON THIS EQUIPMENT					



Page 71. Add appendix IV after appendix III.

## APPENDIX IV

### ORGANIZATIONAL, DS, GS, AND DEPOT REPAIR PARTS

---

#### Section 1. INTRODUCTION

##### A4-1. General

This appendix contains a list of repair parts required for the performance of organizational maintenance and a list covering the corresponding requirements for direct support, general support, and depot maintenance for Operations Central AN/MS-32.

*Note.* No special tools, tests, and support equipment are required.

##### A4-2. Explanation of Sections

This repair parts list is divided into four principal parts:

*a. Prescribed Load Allowance List (PLA), Section II.* The PLA is a consolidated listing of repair parts allocated for initial stockage at organizational maintenance. This is a mandatory minimum stockage allowance.

*b. Repair Parts, Organizational Maintenance, Section III.* Repair parts authorized for organizational maintenance is included in this section.

*c. Repair Parts, DS, GS, and Depot Maintenance, Section IV.* This chart lists repair parts authorized for maintenance performance at direct support, general support, and depot.

*d. Federal Stock Number Index, Section V.* This is a cross-reference index of Federal stock numbers to illustrations by figure and item number.

##### A4-3. Explanation of Columns

An explanation of the columns in sections II through IV is given below.

*a. Source, Maintenance, and Recoverability Codes, Column 1, Sections III and IV.*

- (1) *Source code, column 1a.* The selection status and source for the listed item is noted here. Source code and its explanation is as follows:

Code	Explanation
P-----	Applies to repair parts that are stocked in or supplied from the GSA/DSA, or Army system, and authorized for use at indicated maintenance categories.

- (2) *Maintenance code, column 1b.* The lowest category of maintenance authorized to install the listed item is noted here.

Code	Explanation
O-----	Organizational Maintenance
F-----	Direct Support Maintenance
H-----	General Support Maintenance

- (3) *Recoverability code, column 1c.* The information in this column indicates whether unserviceable items should be returned for recovery or salvage. Recoverability code and its explanation is as follows:

*Note.* When no code is indicated in the recoverability column, the part will be considered expendable.

Code	Explanation
R-----	Applies to repair parts and assemblies which are economically repairable at DSU and GSU activities and normally are furnished by supply on an exchange basis.

## CHAPTER 2

### INSTALLATION AND PREOPERATIONAL PROCEDURES

---

#### Section I. INSTALLATION, CONNECTION, AND TESTING OF INSTALLED EQUIPMENT

##### 9. General

a. When an AN/MS-32 is received, uncrate and check it ( para 10 ) ; then perform the tests given in paragraph 17. When an S-184/MS-32 is received, perform the procedures outlined in ( 1 ) through (4) below.

- (1) Uncrate and check the equipment (para 10).
- (2) Install and interconnect the following equipment:
  - (a) SB-22(\*)/PT (para 11).
  - (b) TA-312/PT (para 12).
  - (c) TH-5/TG's (para 13).
  - (d) TT-76(\*)/GGC (para 14).
  - (e) TT4 (\*)/TG's (para 15).
- (3) Store the TA-125/GT ( para **16a** ) and the J-1077A/U (para 16b); check the LS-147 ( \* ) /FI connections (para 16c).
- (4) Check the equipment (para 17).

b. The signal duct contains all the wiring required to connect the equipment to the external line circuits. All wiring is appropriately marked and prepared for connection. The signal schematic-wiring diagram (fig. 42) SUPplements the information given in the connection procedures. The power duct contains power receptacles appropriately marked for each piece of equipment that requires ac power.

c. A tool kit (para 5b and fig. 2) is used for equipment installation and connection.

Note. Ground (para 20) and connect the power (para 21) to the shelter before using the lights or the convenience receptacles.

##### 10. Uncrating and Checking

a. *Uncrating Shelter (fig. 22).*

- (1) Remove the panels of the crate by re-

moving the bolts. First remove the front and rear panels; then remove the top and side panels.

- (2) Remove the four lag screws that secure the base of the crate to the shelter.
- (3) Remove the sling assembly (fig. 26) from its package on the floor of the shelter (fig. 15).
- (4) Use a device capable of lifting 3,000 pounds to remove the shelter from the base of the crate. Attach the sling assembly to the lifting eyes on the top corners of the shelter (para: 19a) and raise the shelter off the base of the crate.
- (5) *Remove* the base of the crate and lower the shelter.
- (6) Remove the sling assembly from the shelter and the lifting device.

b. *Checking Shelter Contents.* Check the the contents of the shelter against the packing list. If the packing list is not available, use the table of components ( para 5) to check the equipment that *probably* was packed.

#### II. Installation and Connection of SB-22(\*)/PT

a. Remove the front cover of the SB-22 ( \* ) /PT (TM 11-5805-262-12) .

b. Remove headset-handset (H-81/U or H-144/U) from the front cover and store the cover.

c. Open the rear cover of the SB-22 ( \* ) /PT and install four Batteries BA-30 in the battery case.

this column are arranged in alphabetical order.

- (4) Locate the applicable illustration in this manual and note the figure number and item number. Use the repair parts listing and locate the figure and/or item number as noted on the illustration.

b. When the Federal stock number is known, use the repair part listing to find the repair part and the figure and item numbers as noted in the Federal stock number index.

#### A4-5. Federal Supply Codes

This paragraph lists the Federal supply code and the associated manufacturer's name.

Code no.	Manufacturer
00656	AEROVOX Corp.
02461	American Logging Tool Co.
02777	Hopkins Engineering Co.
06229	Electrovert, Inc.
08600	Bridgeport Hardware Mfg. Corp.
08621	Swivelier Co., Inc.
08808	General Electric Co., Lamp Glass-Dept.
16748	Delco Appliance Div of General Motors Corp.

Code no.	Manufacturer
24453	General Electric Distributing Corp.
32572	Justrite Mfg. Co.
38525	Kidde Walter and Co., Inc.
71183	Bryant Electric Co.
71400	Bussmann Mfg., Division of McGraw-Edison Co.
72619	Dialight Corp.
72658	G. C. Electronics Co.
73586	Circle F Industries
78917	Kellems Co.
74545	Hubbell Harvey, Inc.
75915	Littlefuse, Inc.
77166	Pass and Seymour, Inc.
78674	Swivelier Co., Inc.
79796	Woodings Verona Tool Works
80063	Army Electronics Command Procurement and Production Directorate
81349	Military Specifications
82877	Rotron Mfg. Co., Inc.
85838	Erie Art Metal Co., Inc.
86794	Roe Justus and Sons
89285	Benjamin Electric Mfg. Co.
90211	Square D Co.
91929	Honeywell, Inc., Micro Switch Division
93993	Midwest Electric Products, Inc.
95344	Economy Cable Grip Co.
98313	Davis Aircraft Products, Inc.

SECTION II. PRESCRIBED LOAD ALLOWANCE LIST

(1) FEDERAL STOCK NUMBER	(2) DESCRIPTION	MODEL DESIGNATOR	(3) 15-DAY ORG. MAINT. ALLOWANCE				(4) QTY INC IN UN PK
			(A)	(B)	(C)	(D)	
			1-5	6-20	21-50	51-100	
	SHELTER, ELECTRICAL EQUIPMENT S-184/MSC-32, S-184A, B, C, D/MSC-32  NOTE: Model column 1 refers to S-184/MSC-32; column 2 refers to S-184A/MSC-32; column 3 refers to S-184B/MSC-32; column 4 refers to S-184C/MSC-32; column 5 refers to S-184D/MSC-32						
2540-892-6243	LADDER, VEHICLE, BOARDING MX-3391/G	* * * * *	*	*	*	2	
2590-831-6944	CLIP, RETAINING: Holds cable in cradle clips; 06229; N-5	* * * * *	*	*	*	2	
5120-776-9917	GRIP, CABLE JAW: Approx 16 in lg; 95344; EQA-6-8P	* * * * *	*	*	2	2	
5120-776-9918	GRIP, CABLE, JAW: Approx 12 in lg; 95344; EQA-26S	* * * * *	*	*	2	2	
5340-857-1424	CLIP, RETAINING: Holds cable in cradle clips; 06229; N-1	* * * * *	*	2	2	3	
5340-857-1424		* * * * *	*	*	2	2	
5410-792-6335	TIE DOWN PLATE ASSEMBLY: 98313; FDC-1225M5	* * * * *	*	*	*	2	
5410-792-6336	STRAP ASSEMBLY, TIE DCWN: 98313; FDC-1575101-1	* * * * *	*	*	2	2	
5910-553-6096	CAPACITOR, FLXED, PAPER DIELECTRIC: F/fluorescent; 02777; 591B	* * * * *	*	*	2	2	
5910-713-8313	CAPACITOR, FIXED, PAPER DIELECTRIC: F/fan; 00656; P150F83	* * * * *	*	*	*	2	
5925-523-5764	CIRCUIT BREAKER: 90211; Q0-120	* * * * *	*	*	2	2	
5925-682-1061	CIRCUIT BREAKER: 90211; Q0-115	* * * * *	*	*	2	2	
5930-075-7231	SWITCH, TOGGLE: 08808; 5051-1	* * * * *	*	*	2	2	
5930-548-5150	SWITCH, TOGGLE: 73586; 3036	* * * * *	*	*	*	2	
5930-615-7896	SWITCH, TOGGLE: 81349; MS25098-22	* * * * *	*	*	2	2	
5930-636-4014	SWITCH, TOGGLE: 08808; 5521-1	* * * * *	*	*	2	2	
5935-045-9830	CONNECTOR, PLUG, ELECTRICAL U-185B/G: F/26 pr cable assys	* * * * *	*	*	2	2	
5935-064-5731	CONNECTOR, PLUG, ELECTRICAL U-237/G: F/pwr cable assys	* * * * *	*	*	2	2	
5935-064-5732	CONNECTOR, RECEPTACLE, ELECTRICAL U-238/G: Mtd in pwr ent box	* * * * *	*	*	*	2	
5935-192-4826	JACK, TELEPHONE: 81349; JJ-086	* * * * *	*	*	2	2	
5935-199-0275	CONNECTOR, RECEPTACLE, ELECTRICAL: 74545; 9213	* * * * *	*	*	2	2	
5935-228-4038	JACK, TELEPHONE: 81349; JJ-085	* * * * *	*	*	2	2	
5935-259-3313	CONNECTOR, RECEPTACLE, ELECTRICAL: 74545; 7210B	* * * * *	*	*	*	2	

PRESCRIBED LOAD ALLOWANCE									
(1) FEDERAL STOCK NUMBER	(2) DESCRIPTION	(3) 15-DAY ORG. MAINT. ALLOWANCE				(4) QTY INC IN UN PK			
		(A)	(B)	(C)	(D)				
		1-5	6-20	21-50	51-100				
		MODEL DESIGNATOR							
	AN/MS-C-32 (continued)								
5935-283-1269	JACK, TELEPHONE: 80063; SC-D-19393	* * * * *	*	*	*	2			
5935-295-3129	CONNECTOR, RECEPTACLE, ELECTRICAL: Duplex; 74545; 5262	* * * * *	*	*		2	2		
5935-359-6025	CONNECTOR, RECEPTACLE, ELECTRICAL: Simplex; 74545; 9210	* * * * *	*	*		2	2		
5935-549-3562	CONNECTOR, RECEPTACLE, ELECTRICAL: Duplex; 74545; 9200	* * * * *	*	*		2	2		
5935-594-3562		* * * * *	*	*	*		2		
5935-646-5908	CONNECTOR, PLUG, ELECTRICAL: 74545; 9754	* * * * *	*	*		2	2		
5935-682-0381	CONNECTOR, RECEPTACLE, ELECTRICAL U-187/G	* * * * *	*	*	*		2		
5940-223-5293	POST BINDING U-106/U	* * * * *	*	2	2		3		
5940-254-2244	CAP, ELECTRICAL: F/U-106/U; 80063; SC-C-76202-1	* * * * *	*	2	2		3		
5975-656-5260	ROD, GROUND MX-148/G	* * * * *	*	*		2	2		
5975-705-5841	CLIP, RETAINING: Holds cable in cradle clips; 06229; N-3	* * * * *	*	*	*		2		
5975-705-5841		* * * * *	*	*		2	2		
5995-752-2515	CORD ASSEMBLY, ELECTRICAL: 2 ft 6 in lg; red; 80063; SM-D-352594-GR III	* * * * *	*	*		2	2		
5995-752-2516	CORD ASSEMBLY, ELECTRICAL: 2 ft 6 in lg; black; 80063; SM-D-352593-GR III	* * * * *	*	*		2	2		
5995-752-2566	CABLE ASSEMBLY, TELEPHONE: F/LS-147C/FI and TA-312/PT; 4 ft lg; 80063; SM-D-383873-GR III	* * * * *	*	*		2	2		
5995-752-2593	CORD ASSEMBLY, ELECTRICAL: 2 ft 6 in lg; green; 80063; SM-D-352596-GR III	* * * * *	*	*		2	2		
5995-752-2594	CORD ASSEMBLY, ELECTRICAL: 2 ft 6 in lg; white; 80063; SM-D-352595-GR III	* * * * *	*	*		2	2		
5995-823-3016	CABLE ASSEMBLY, TELEPHONE: F/TTY; black plug; 6 ft lg; 80063; SM-D-384145-GR I	* * * * *	*	*	*		2		
5995-889-0608	CABLE ASSEMBLY, TELEPHONE: F/TTY; red plug; 80063; SM-D-384145-GR II	* * * * *	*	*	*		2		
6105-561-6321	MOTOR ALTERNATING CURRENT: 16748; A8265M1	* * * * *	*	*	*		2		
6105-792-8384	MOTOR, ALTERNATING CURRENT: 82877; 23396-01	* * * * *	*	*	*		2		
6210-754-8134	SHIELD LIGHT: F/fluorescent; 80063; SM-C-349983	* * * * *	*	*		2	2		
6230-615-5384	LIGHT, EXTENSION: 81349; W-L-661, type 1, class 1	* * * * *	*	*	*		2		
6230-729-9614	LANTERN, ELECTRIC: 32572; 2106-7	* * * * *	*	*	*		2		

PRESCRIBED LOAD ALLOWANCE									
(1) FEDERAL STOCK NUMBER	(2) DESCRIPTION	(3) 15-DAY ORG. MAINT. ALLOWANCE				(4) QTY INC IN UN PK			
		MODEL DESIGNATOR							
		(A) 1-5	(B) 6-20	(C) 21-50	(D) 51-100				
	AN/MSC-32 (continued)								
6240-143-3070	LAMP, INCANDESCENT: 08808; 50W/RS	*	*	*	*	*	2	2	3
6240-155-7786	LAMP, INCANDESCENT: F/lantern; 08808; PR-2	*	*	*	*	*	*	2	2
6240-179-1814	LAMP, GLOW NE-45	*	*	*	*	*	2	2	3
6240-299-5876	LAMP, GLOW NE-34	*	*	*	*	*	*	*	2
6240-538-8447	LAMP, FLUORESCENT: 08808; F20T12/CW	*	*	*	*	*	2	3	5
6250-174-4684	LAMPHOLDER: F/fluorescent; incl starter socket; 08808; 78X736	*	*	*	*	*	*	*	2
6250-299-2884	STARTER, FLUORESCENT LAMP: 71183; FS-2	*	*	*	*	*	2	2	3
6250-299-6093	LAMPHOLDER: F/fluorescent; 08808; 78X491	*	*	*	*	*	*	*	2
6250-752-1233	LAMPHOLDER: 72619; 4-74-6	*	*	*	*	*	*	2	2
6250-804-3449	BALLAST, LAMP: F/fluorescent; 08808; 89G457D	*	*	*	*	*	*	2	2

SECTION III. REPAIR PARTS FOR ORGANIZATIONAL MAINTENANCE

SOURCE CD	MAINT. CD	REC. CODE	(2) FEDERAL STOCK NUMBER						(3) DESCRIPTION	(4) UNIT OF ISSUE	(5) QTY INC IN PK	(6) QTY INC IN UNIT	(7) 15 DAY ORG. MAINT. ALW.				(8) ILLUSTRATIONS	
			MODEL										(A) FIGURE NUMBER	(a) ITEM OR SYMBOL NUMBER				
			1	2	3	4	5	6							(A) 5-1	(B) 6-20	(C) 21-50	(D) 51-100
			5895-021-2090						OPERATIONS CENTRAL AN/MSC-32 (This item is nonexpendable.)  SHELTER, ELECTRICAL EQUIPMENT S-184/MSC-32, S-184A, B, C, D/MSC-32  NOTE: Model column 1 refers to S-184/MSC-32; column 2 refers to S-184A/MSC-32; column 3 refers to S-184B/MSC; column 4 refers to S-184C/MSC-32; column 5 refers to S-184D/MSC-32.									
P	0		6625-892-5315	*	*	*	*	*	AMMETER: 81349; MR36W05OSPECR	ea	1	*	*	*	*	41	M2	
P	0		4210-727-8111	*	*	*	*	*	AXE, PICKHEAD: 02461; 276	ea	1	*	*	*	*	14		
P	0		5110-293-2339					*	AXE: 81349; GGG-A-926, type 1, class 1, design B	ea	1	*	*	*	*	14		
P	0		6250-804-3449	*	*	*	*	*	BALLAST, LAMP: F/fluorescent; 08808; 89G457D	ea	8	*	*	2	2	36		
P	0		4210-383-7127	*	*	*	*	*	BRACKET: F/2-1/2 lb fire extinguisher; 33525; PRB-2-1/2	ea	1	*	*	*	*	11		
P	0		4210-268-9729	*	*	*	*	*	BRACKET: F/5 lb fire extinguisher; 33525; RB-1	ea	1	*	*	*	*	14		
P	0		7920-178-8315	*	*	*	*	*	BRUSH, DUSTING, BENCH: 80063; SC-C-539469	ea	1	*	*	*	*	14		
P	0		6145-752-2473	*	*	*	*	*	CABLE, POWER, ELECTRICAL WT-26/U: For power cable assys	ft	115	*	*	*	*			
P	0		6145-283-9475	*	*	*	*	*	CABLE, POWER, ELECTRICAL: F/line cord; 81349; CO-03HGF(3/14)0560	ft	20	*	*	*	*			
P	0		6145-985-7704	*	*	*	*	*	CABLE, POWER, ELECTRICAL: F/fan; 81349; CO-02MGF(2/16)0338	ft	10	*	*	*	*			
P	0		6145-889-1136	*	*	*	*	*	CABLE, TELEPHONE WM-61A/U: F/8 ft handset-headset extension cable	ft	8	*	*	*	*			
P	0		5995-889-1500	*	*	*	*	*	CABLE ASSEMBLY, POWER, ELECTRICAL CX-7453/U: 100 ft pwr cable assy	ea	1	*	*	*	*			

SOURCE CD (1)	MAINT. CD (2)	REC. CODE (3)	REPAIR PARTS FOR ORGANIZATIONAL MAINTENANCE						(4) UNIT OF ISSUE	(5) QTY INC IN UN PK	(6) QTY INC IN UNIT	(7) 15 DAY ORG. MAINT. ALW.				(8) ILLUSTRATIONS	
			(2) FEDERAL STOCK NUMBER	(3) MODEL								(3) DESCRIPTION	(A) FIGURE NUMBER	(B) ITEM OR SYMBOL NUMBER			
				1	2	3	4	5							6		
																(A) 5-1	(B) 02-9
P	O		4940-752-2474	*	*	*	*		AN/MS-32 (continued)	ea	1	*	*	*	*	2	
P	O		5995-889-0803	*	*	*	*		CABLE ASSEMBLY, POWER ELECTRICAL: Line cord; 80063; SM-D-350987	ea	1	*	*	*	*	2	
P	O		5995-681-8440	*	*	*	*		CABLE ASSEMBLY, TELEPHONE CX-4760A/U: 15 ft lg	ea	1	*	*	*	*	3	
P	O		5995-752-2566	*	*	*	*		CABLE ASSEMBLY, TELEPHONE: F/LS-147C/FI and TA-312/PT; 4 ft lg; 80063; SM-D-383873-GR III	ea	5	*	*	2	2	3	
P	O		5995-889-0923	*	*	*	*		CABLE ASSEMBLY, TELEPHONE: F/SB-22/PT; 80063; SM-C-353715	ea	1	*	*	*	*	23	
P	O		5995-823-3016	*	*	*	*		CABLE ASSEMBLY, TELEPHONE: F/TTY; Black plug; 6 ft lg; 80063; SM-D-384145-GR I	ea	2	*	*	*	2	2	
P	O		5995-889-0608	*	*	*	*		CABLE ASSEMBLY, TELEPHONE: F/TTY; red plug; 80063 SM-D-384145-GR II	ea	2	*	*	*	2	2	
P	O		5940-254-2244	*	*	*	*		CAP, ELECTRICAL: F/U-106/U; 80063; SC-C-76202-1	ea	52	*	2	2	3	8, 9	
P	O		5910-713-8313	*		*			CAPACITOR, FIXED, PAPER DIELECTRIC: F/fan; 00656; P150P83	ea	2	*	*	*	2	34	C1
P	O		5910-553-6096	*	*	*	*		CAPACITOR, FIXED, PAPER DIELECTRIC: F/fluorescent; 02777; 591B	ea	8	*	*	2	2		
P	O		5925-682-1061	*	*	*	*		CIRCUIT BREAKER: 90211; Q0-115	ea	3	*	*	2	2	41	CB1, CB2, CB5
P	O		5925-523-5764	*	*	*	*		CIRCUIT BREAKER: 90211; A0-120	ea	3	*	*	2	2	41	CB3, CB4, CB6
P	O		5925-682-1071	*	*	*	*		CIRCUIT BREAKER: 90211; Q0-250	ea	1	*	*	*	*	41	CB7
P	O		5340-857-1424	*	*	*	*		CLIP, RETAINING: Holds cable in cradle clips; 06229; N-1	ea	39	*	2	2	3		
P	O		5340-857-1424	*	*	*	*		CLIP, RETAINING: Holds cable in cradle clips; 06229; N-3	ea	19	*	*	2	2		
P	O		5975-705-5841	*	*	*	*		CLIP, RETAINING: Holds cable in cradle clips; 06229; N-3	ea	6	*	*	*	2		
P	O		5975-705-5841	*	*	*	*		CLIP, RETAINING: Holds cable in cradle clips; 06229; N-3	ea	9	*	*	2	2		



SOURCE CD (2)	(1)			REPAIR PARTS FOR ORGANIZATIONAL MAINTENANCE												(8)				
	MAINT. CD (5)	REC. CODE (C)	(2) FEDERAL STOCK NUMBER	(3) DESCRIPTION						(4) UNIT OF ISSUE	(5) QTY INC IN UN PK	(6) QTY INC IN UNIT	(7) 15 DAY ORG. MAINT. ALW.				(A) FIGURE NUMBER	(B) ITEM OR SYMBOL NUMBER		
				MODEL									(A)	(B)	(C)	(D)				
				1	2	3	4	5	6											
P	O		2590-831-6944	*	*	*	*				AN/MSC-32 (continued)	ea		5	*	*	*	2		
P	O	R	6645-800-7094	*							CLOCK, AIRCRAFT, MECHANICAL: 80063; SC-C-539475	ea		1	*	*	*	*	13	
P	O	R	6645-303-4950	*	*	*	*				CLOCK, AIRCRAFT, MECHANICAL: 81349; MIL-C-7939A, type AT-11, AN/5743-2 (Note: When replacing retain mtg bkt for installing new clock.)	ea		1	*	*	*	*	13	
P	O	R	6645-526-4395			*					CLOCK, AIRCRAFT, MECHANICAL: 80063; SM-B-472589-5 (Note: When replacing retain mtg bkt for installing new clock.)	ea		1	*	*	*	*	13	
P	O		6605-892-5399	*	*	*	*	*			COMPASS, MAGNETIC: 81349; MIL-C-10436	ea		1	*	*	*	*		
P	O		5935-283-2950	*	*	*	*	*			CONNECTOR, PLUG, ELECTRICAL U-77/U: F/8 ft handset-headset extension cable assy.	ea		1	*	*	*	*		
P	O		5935-283-2884	*	*	*	*	*			CONNECTOR, PLUG, ELECTRICAL U-78/U: F/8 ft handset-headset extension cable assy	ea		1	*	*	*	*		
P	O		5935-045-9830	*	*	*	*	*			CONNECTOR, PLUG, ELECTRICAL U-185B/G: F/26 pr cable assys	ea		3	*	*	*	2	2	
P	O		5935-064-5731	*	*	*	*	*			CONNECTOR, PLUG, ELECTRICAL U-237/G: F/pwr cable assys	ea		3	*	*	*	2	2	
P	O		5935-646-5908	*	*	*	*				CONNECTOR, PLUG, ELECTRICAL: 74545; 9754	ea		4	*	*	*	2	2	
P	O		5935-646-5908					*				ea		3	*	*	*	2	2	
P	O		5935-192-1294	*	*	*	*	*			CONNECTOR, PLUG, ELECTRICAL: F/SB-22/PT Cable Assy; 81349; MS3108B-28-12P	ea		1	*	*	*	*		
P	O		5935-504-3637					*			CONNECTOR, PLUG, ELECTRICAL: 74545; 9755	ea		1	*	*	*	*		
P	O		5935-682-0381	*	*	*	*	*			CONNECTOR, RECEPTACLE, ELECTRICAL U-187/G	ea		2	*	*	*	*	2	
P	O		5935-064-5732	*	*	*	*	*			CONNECTOR, RECEPTACLE, ELECTRICAL U-238/G: Mtd in pwr ent box	ea		2	*	*	*	*	2	8

SOURCE CD (3)	MAINT. CD (8)	REC. CODE (9)	REPAIR PARTS FOR ORGANIZATIONAL MAINTENANCE						(4) UNIT OF ISSUE	(5) QTY INC IN UN PK	(6) QTY INC IN UNIT	(7) 15 DAY ORG. MAINT. ALW.				(8) ILLUSTRATIONS	
			(2) FEDERAL STOCK NUMBER	(3) DESCRIPTION								(A) FIGURE NUMBER	(B) ITEM OR SYMBOL NUMBER				
				MODEL													
			1	2	3	4	5	6			(A) 5-1	(B) 02-9	(C) 05-12	(D) 00-15			
P	0		5935-665-5708	*	*	*	*	*	AN/MSC-32 (continued)	ea	1	*	*	*	*	13	
									CONNECTOR, RECEPTACLE, ELECTRICAL: F/SB-22/PT; 81349; MS3102A-28-12S								
P	0		5935-259-3313	*	*	*	*	*	CONNECTOR, RECEPTACLE, ELECTRICAL: 74545; 7210B	ea	2	*	*	*	*	41	J4, J17
P	0		5935-549-3562	*	*	*	*	*	CONNECTOR, RECEPTACLE, ELECTRICAL: Duplex; 74545;	ea	8	*	*	2	2	41	J3, J5, J6, J7, J14, J15, J16
P	0		5935-594-3562	*	*	*	*	*	CONNECTOR, RECEPTACLE, ELECTRICAL: Simplex; 74545;	ea	2	*	*	*	*	2	
P	0		5935-359-6025	*	*	*	*	*	CONNECTOR, RECEPTACLE, ELECTRICAL: Simplex; 74545; 9210	ea	3	*	*	2	2	41	J8, J9, J11
P	0		5935-359-6025	*	*	*	*	*	CONNECTOR, RECEPTACLE, ELECTRICAL: 74545; 9213	ea	1	*	*	*	*		
P	0		5935-199-0275	*	*	*	*	*	CONNECTOR, RECEPTACLE, ELECTRICAL: Duplex; 74545; 5262	ea	4	*	*	2	2	41	J10, J12, J13
P	0		5935-295-3129	*	*	*	*	*	CORD ASSEMBLY, ELECTRICAL: 2 ft 6 in lg; black; 80063; SM-D-352593-GR III	ea	10	*	*	2	2		
P	0		5995-752-2516	*	*	*	*	*	CORD ASSEMBLY, ELECTRICAL: 2 ft 6 in lg; red; 80063; SM-D-352594-GR III	ea	3	*	*	2	2	3	
P	0		5995-752-2515	*	*	*	*	*	CORD ASSEMBLY, ELECTRICAL: 2 ft 6 in lg; white; 80063; SM-D-352595-GR III	ea	3	*	*	2	2	3	
P	0		5995-752-2594	*	*	*	*	*	CORD ASSEMBLY, ELECTRICAL: 2 ft 6 in lg; green; 80063; SM-D-352596-GR III	ea	3	*	*	2	2	3	
P	0		5995-752-2593	*	*	*	*	*	CORD ASSEMBLY, ELECTRICAL: 2 ft 6 in lg; gray; 80063; SM-D-352597-GR III	ea	4	*	*	2	2	3	
P	0		5995-752-2597	*	*	*	*	*	CURTAIN, BLACKOUT: Left hand; 80063; SM-C-352521-2	ea	1	*	*	*	*		
P	0		5410-792-6341	*	*	*	*	*	CURTAIN, BLACKOUT: Right hand; 80063; SM-C-352521-1	ea	1	*	*	*	*		
P	0		5120-408-1481	*	*	*	*	*	EXTRACTOR, ELECTRON TUBE: F/7 pin; 73917; TP-11-16	ea	1	*	*	*	*	14	
P	0		5120-293-2692	*	*	*	*	*	EXTRACTOR, ELECTRON TUBE: F/9 pin; 73917; TP-13-16	ea	1	*	*	*	*	14	

SOURCE CD	MAINT. CD	REC. CODE	(1) REPAIR PARTS FOR ORGANIZATIONAL MAINTENANCE						(4) UNIT OF ISSUE	(5) QTY INC IN UN PK	(6) QTY INC IN UNIT	(7) 15 DAY ORG. MAINT. ALW.				(8) ILLUSTRATIONS	
			(2) FEDERAL STOCK NUMBER	(3) DESCRIPTION								(A) FIGURE NUMBER	(B) ITEM OR SYMBOL NUMBER				
				MODEL													
			1	2	3	4	5	6			(A) 1-5	(B) 6-10	(C) 11-50	(D) 51-100			
P	0		6230-012-4520	*	*	*	*	*	AN/MS-32 (continued)	ea	2	*	*	*	*	16	
P	0		6210-752-2543	*	*	*	*	*	FLXTURE, LIGHTING: (Spotlight) 08621; 20463	ea	2	*	*	*	*	16	
P	0		5120-776-9917	*	*	*	*	*	GRIP, CABLE JAW: Approx 16 in lg; 95344; EQA-6-8P	ea	13	*	*	2	2	2	
P	0		5120-776-9918	*	*	*	*	*	GRIP, CABLE, JAW: Approx 12 in lg; 95344; EQA-268	ea	12	*	*	2	2	2	
P	0		5120-251-4489	*	*	*	*	*	HAMMER, HAND: 79796; 15	ea	1	*	*	*	*	14	
P	0		4140-792-8395	*	*	*	*	*	IMPELLER, FAN: 82877; 23396-02	ea	2	*	*	*	*		
P	0		5935-283-1269	*	*	*	*	*	JACK, TELEPHONE: 80063; SC-D-19393	ea	7	*	*	*	2	42	J1 thru J7
P	0		5935-228-4038	*	*	*	*	*	JACK, TELEPHONE: 81349; JJ-085	ea	18	*	*	2	2	42	J1 thru J15, J26, J27, J28
P	0		5935-192-4826	*	*	*	*	*	JACK, TELEPHONE: 81349; JJ-086	ea	24	*	*	2	2	42	J1 thru J7, J16 thru J35
P	0		2540-892-6243	*	*	*	*	*	LADDER, VEHICLE, BOARDING MK-3391/G	ea	1	*	*	*	2	15	
P	0		6240-538-8447	*	*	*	*	*	LAMP, FLUORESCENT: 08808; F20T12/CW	ea	8	*	2	3	5	41	DS8 thru DS15
P	0		6240-299-5876	*	*	*	*	*	LAMP, GLOW NE-34	ea	1	*	*	*	2	41	DS7
P	0		6240-179-1814	*	*	*	*	*	LAMP, GLOW NE-45	ea	9	*	2	2	3	10, 35	
P	0		6240-155-7786	*	*	*	*	*	LAMP, INCANDESCENT: F/lantern; 08808; PR-2	ea	1	*	*	2	2		
P	0		6240-143-3070	*	*	*	*	*	LAMP, INCANDESCENT: 08808; 50W/RS	ea	4	*	2	2	3		
P	0		6210-274-5647	*	*	*	*	*	LAMPHOLDER: For night light; f/50 w bulb; 74545; 456	ea	1	*	*	*	*	13	
P	0		6250-109-1091	*	*	*	*	*	LAMPHOLDER: 77166; P823J	ea	1	*	*	*	*	41	XDS7
P	0		6250-752-1233	*	*	*	*	*	LAMPHOLDER: 72619; 4-74-6	ea	9	*	*	2	2	41 35	XDS1 thru XDS6 XDS1, XDS2, XDS3

SOURCE CD	(1)		REPAIR PARTS FOR ORGANIZATIONAL MAINTENANCE					(4) UNIT OF ISSUE	(5) QTY INC IN UN PK	(6) QTY INC IN UNIT	(7) 15 DAY ORG. MAINT. ALW.				(8) ILLUSTRATIONS			
	MAINT. CD	REC. CODE	(2) FEDERAL STOCK NUMBER	(3) DESCRIPTION							(A) 5-1	(B) 6-20	(C) 05-12	(D) 51-100	(A) FIGURE NUMBER	(B) ITEM OR SYMBOL NUMBER		
				MODEL														
				1	2	3	4										5	6
P	O		6250-299-6093	*	*	*	*	*	AM/MSC-32 (continued)	ea	8	*	*	*	2	41	XDS8 thru XDS15	
P	O		6250-174-4684	*	*	*	*	*	LAMPHOLDER: F/fluorescent; incl starter socket; 08808; 78X736	ea	8	*	*	*	2	41	XDS8 thru XDS15	
P	O		6230-729-9614	*	*	*	*	*	LANTERN, ELECTRIC: 32572; 2106-7	ea	1	*	*	*	2			
P	O		5410-752-2525	*	*	*	*	*	LEAD, ELECTRICAL: 80063; SM-B-539592	ea	2	*	*	*	*	2		
P	O		6230-615-5384	*	*	*	*	*	LIGHT, EXTENSION: 81349; W-L-661, type 1, class 1	ea	1	*	*	*	2	2		
P	O		6105-792-8384	*		*			MOTOR, ALTERNATING CURRENT: 82877; 23396-01	ea	2	*	*	*	2			
P	O		6105-561-6321	*	*				MOTOR, ALTERNATING CURRENT: 16748; A8265M1	ea	2	*	*	*	2			
P	O		6105-999-4814					*	MOTOR, ALTERNATING CURRENT: 24453; KH37KG712X	ea	1	*	*	*	*			
P	O		5940-223-5293	*	*	*	*	*	POST BINDING U-106/U	ea	52	*	2	2	3	8, 9		
P	O		8130-656-1090	*	*	*	*	*	REEL, CABLE RC-435/U	ea	2	*	*	*	*			
P	O		5410-793-2021						REPAIR KIT, ELECTRONIC EQUIPMENT SHELTER MX-680/G: (Note: To be requisitioned for immediate use only, order direct from depot stock.)	ea								
P	O		5975-656-5260	*	*	*	*	*	ROD, GROUND MX-148/G	ea	2	*	*	2	2	6		
P	O		6230-474-4497	*	*	*	*	*	SHADE, LAMP: 89285; 365P	ea	1	*	*	*	*	13		
P	O		6210-754-8134	*	*	*	*	*	SHIELD LIGHT: F/fluorescent; 80063; SM-C-349983	ea	8	*	*	2	2			
P	O		6250-299-2884	*	*	*	*	*	STARTER, FLUORESCENT LAMP: 71183; FS-2	ea	8	*	2	2	3			
P	O		5410-792-6336	*	*	*	*	*	STRAP ASSEMBLY, TIE DOWN: 98313; FDC-1575101-1	ea	6	*	*	2	2	2		
P	O		5930-752-3082	*	*	*	*	*	SWITCH, SENSITIVE: 91929; BZ-2RQ-181-P4	ea	1	*	*	*	*	41	S1	
P	O		5930-615-7896	*	*	*	*	*	SWITCH, TOGGLE: 81349; MS25098-22	ea	3	*	*	2	2	41	S1, S2, S3	
P	O		5930-075-7231					*	SWITCH, TOGGLE: 08808; 5051-1	ea	3	*	*	2	2	41	S1, S2, S3	

SOURCE CD	(C)		REPAIR PARTS FOR ORGANIZATIONAL MAINTENANCE						UNIT OF ISSUE	(5) QTY INC IN UN PK	(6) QTY INC IN UNIT	(7) 15 DAY ORG. MAINT. ALW.				(8) ILLUSTRATIONS	
	MAINT. CD	REC. CODE	(2) FEDERAL STOCK NUMBER	(3) DESCRIPTION								(A) FIGURE NUMBER	(B) ITEM OR SYMBOL NUMBER				
				MODEL													
				1	2	3	4	5						6			
										(A)	(B)	(C)	(D)				
P	0		5930-548-5150	*	*	*	*		AN/MSC-32 (continued)	ea	2	*	*	*	2	41	S5, S6
P	0		5930-636-4014	*	*	*	*		SWITCH, TOGGLE: 73586; 3036	ea	4	*	*	2	2	41	S2, S3, S4, S7
P	0		5930-636-4014	*	*	*	*	*	SWITCH, TOGGLE: 08808; 5521-1	ea	3	*	*	2	2		
P	0		5410-792-6335	*	*	*	*	*	TIE DOWN PLATE ASSEMBLY: 98313; FDC-1225M5	ea	6	*	*	*	2		
P	0		5950-705-9105	*	*	*	*	*	TRANSFORMER, CURRENT: 93993; 3CT-35B	ea	1	*	*	*	*	41	T1
P	0		6625-883-4272	*	*	*	*	*	VOLTMETER: 81349; MR36W150ACVVR	ea	1	*	*	*	*	41	M1

SECTION IV. REPAIR PARTS, DS, GS, AND DEPOT MAINTENANCE

SOURCE CD	MAINT. CD	REC. CODE	(1) REPAIR PARTS FOR DIRECT SUPPORT, GENERAL SUPPORT, AND DEPOT MAINTENANCE							(4) UNIT OF ISSUE	(5) QTY INC IN UN PK	(6) QTY INC IN UNIT	(7) 30 DAY MAINT. ALW.						(8) 1 YR. ALW. PER 100 EQUIP. CNTG CY PL.	(9) DEPOT MAINT. ALW. PER 100 EQUIP.	(10) ILLUSTRATIONS																
			(2) FEDERAL STOCK NUMBER	(3) MODEL									(3) DESCRIPTION	DS			GS				(A) FIGURE NUMBER	(B) ITEM OR SYMBOL NUMBER															
				1	2	3	4	5	6					IND CD	1-20	21-50	51-100	1-20					21-50	51-100													
			5895-021-2090																																		
P	0		6625-892-5315	*	*	*	*	*			ea	1	*	*	*	*	*	*		5	5	41			M2												
P	0		4210-727-8111	*	*	*	*				ea	1	*	*	*	*	*	*		5	5	14															
P	0		5110-293-2339						*																												
P	0		6250-804-3449	*	*	*	*	*			ea	8	*	2	2	*	2	2		27	15	36															
P	0		4210-383-7127	*	*	*	*	*			ea	1	*	*	*	*	*	*		4	5	11															
P	0		4210-268-9729	*	*	*	*	*			ea	1	*	*	*	*	*	*		4	5	14															
P	0		7920-178-8315	*	*	*	*	*			ea	1	*	*	*	*	*	*		8	3	14															
P	0		6145-752-2473	*	*	*	*	*			ft	115	*	*	*	*	*	*		406	1150																
P	0		6145-283-9475	*	*	*	*	*			ft	20	*	*	*	*	*	*		83	200																
P	0		6145-985-7704	*	*	*	*	*			ft	10	*	*	*	*	*	*		46	100																

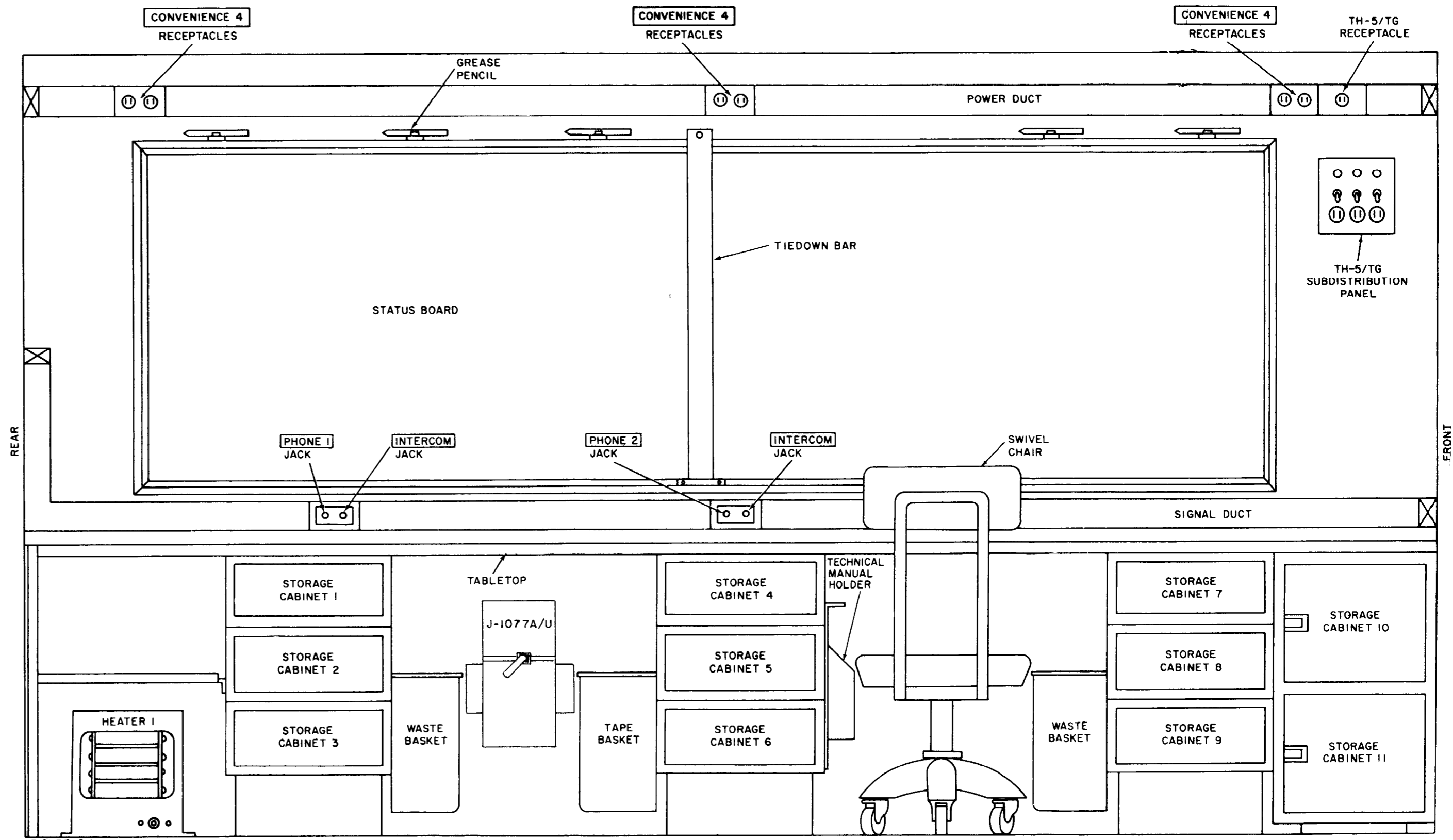

FIGURE 12.1

EL7QU001

Figure 12.1. Operations Central AN/MS-32, roadside wall, elevation drawing (Modified Shelter).

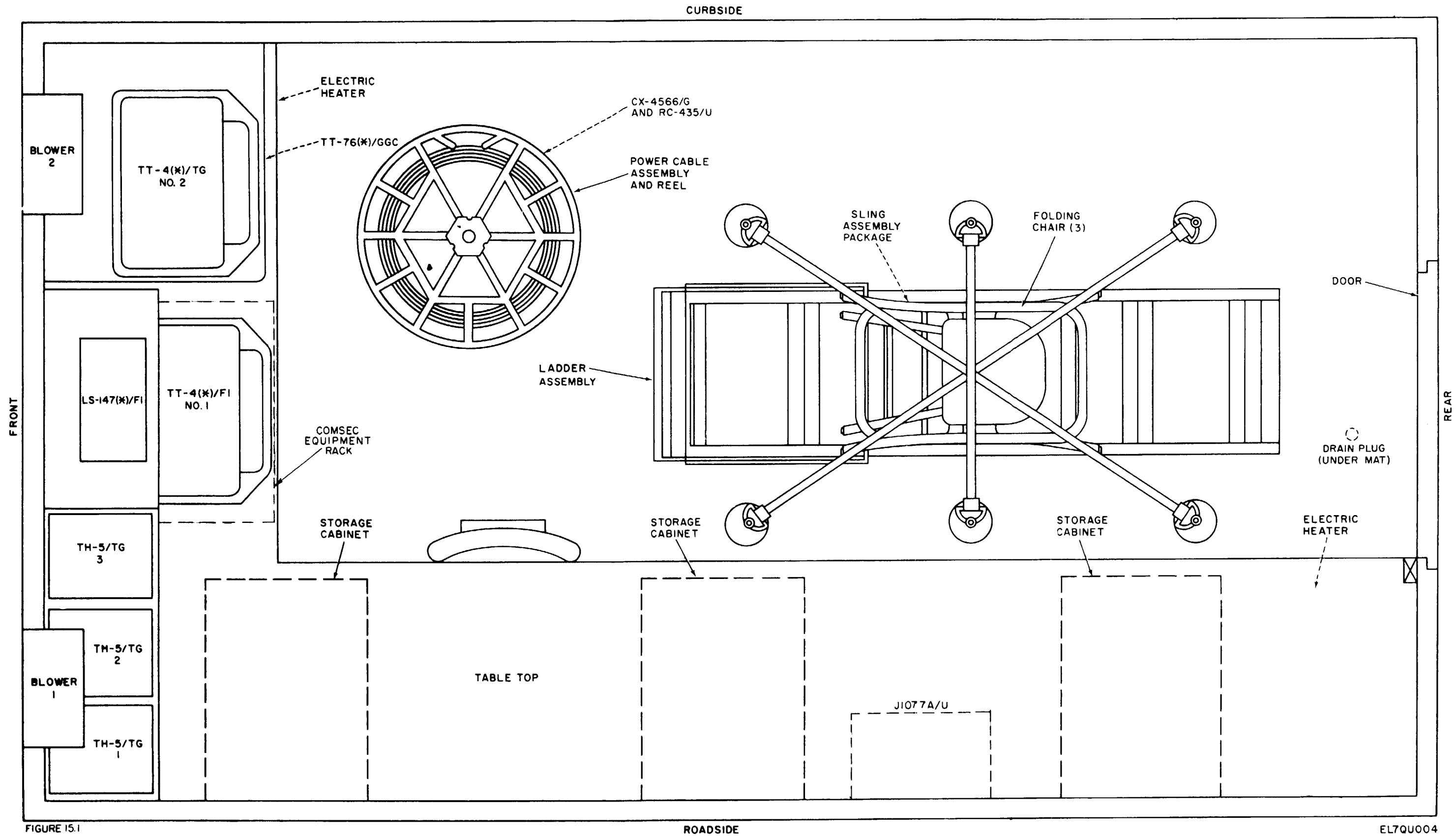
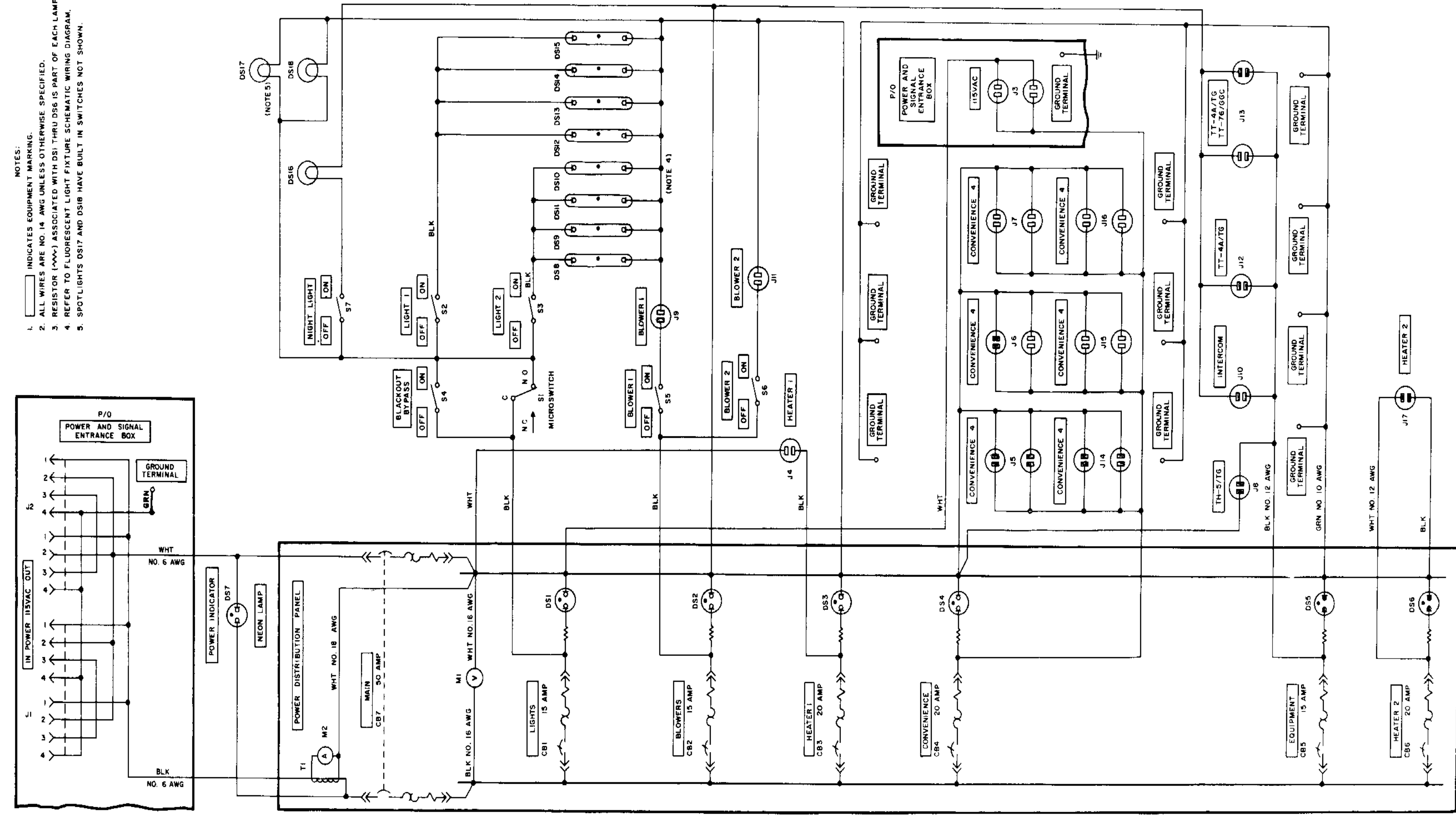

FIGURE 15.1

EL7QU004

Figure 15. Operations Central AN/MS-32 floor plan (Modified Shelter).





- NOTES:
1. [Symbol] INDICATES EQUIPMENT MARKING.
  2. ALL WIRES ARE NO. 14 AWG UNLESS OTHERWISE SPECIFIED.
  3. RESISTOR (---) ASSOCIATED WITH DS1 THRU DS6 IS PART OF EACH LAMP FIXTURE.
  4. REFER TO FLUORESCENT LIGHT FIXTURE SCHEMATIC WIRING DIAGRAM.
  5. SPOTLIGHTS DS17 AND DS18 HAVE BUILT IN SWITCHES NOT SHOWN.

Figure 41. Operations Central AN/MS-32 power schematic-wiring diagram.

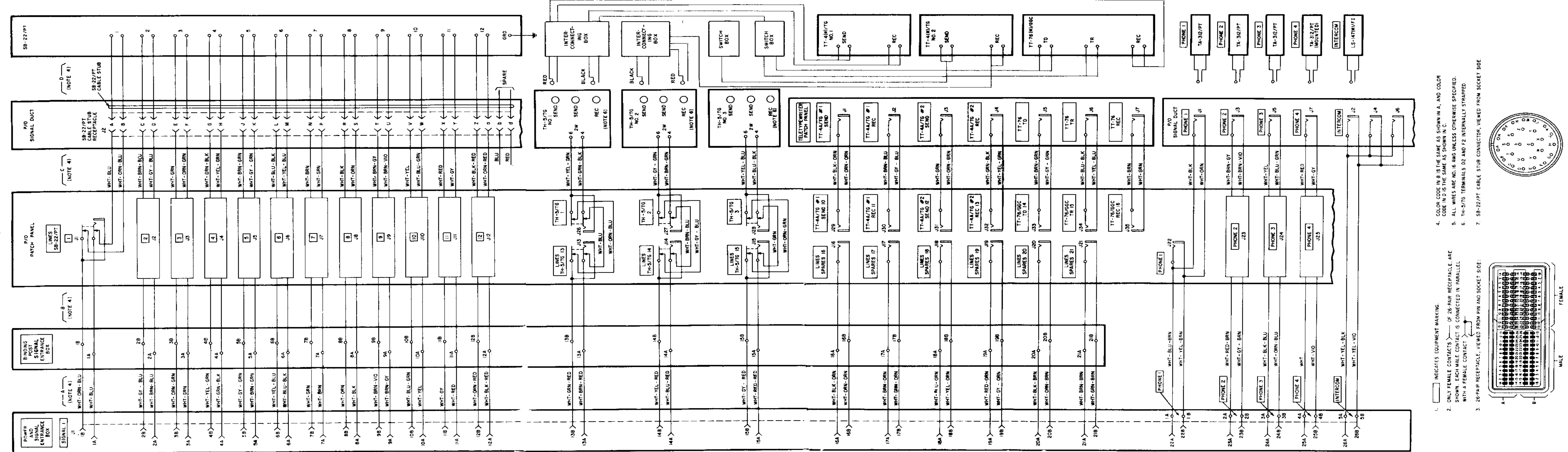

1. [ ] INDICATES EQUIPMENT MARKING.
2. ONLY FEMALE CONTACTS OF 26-PAIR RECEPTACLE ARE SHOWN. EACH MALE CONTACT IS CONNECTED IN PARALLEL WITH A FEMALE CONTACT.
3. 26-PAIR RECEPTACLE, VIEWED FROM PIN AND SOCKET SIDE:
4. COLOR CODE IN B IS THE SAME AS SHOWN IN A, AND COLOR CODE IN D IS THE SAME AS SHOWN IN C.
5. ALL WIRES ARE NO. 16 AWG UNLESS OTHERWISE SPECIFIED.
6. TH-5/TG TERMINALS D2 AND F2 INTERNALLY STRAPPED.
7. SB-22/PT CABLE STUB CONNECTOR, VIEWED FROM SOCKET SIDE.

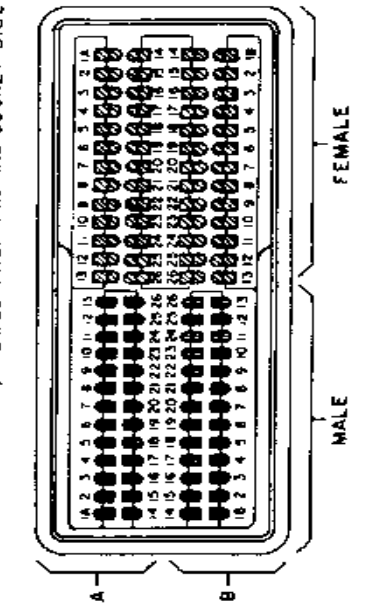
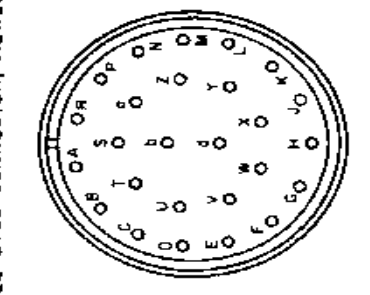

Figure 42.1. Operations Central AN/MSC-32, Signal Shelter Schematic-wiring diagram (Modified Shelter).

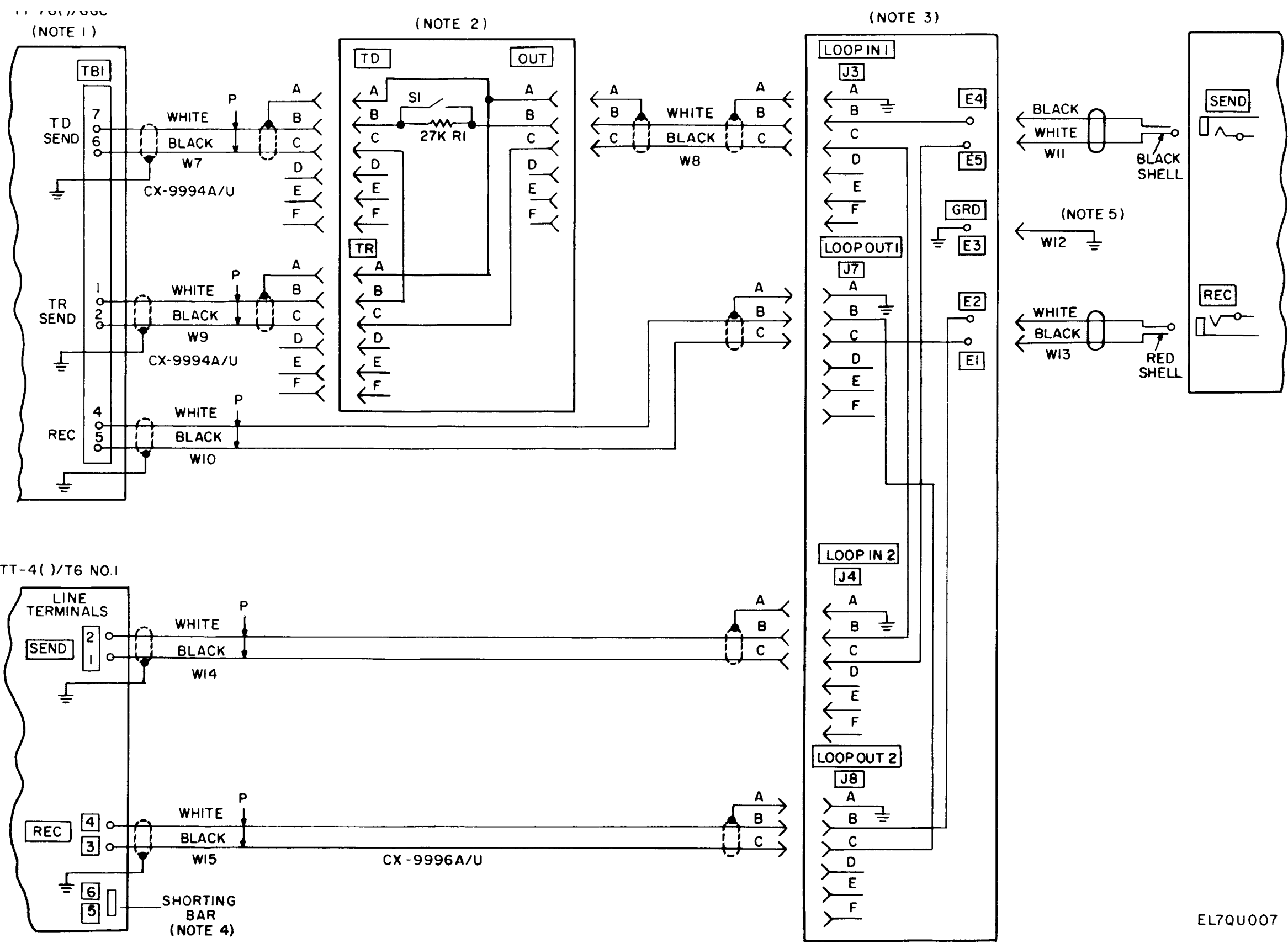
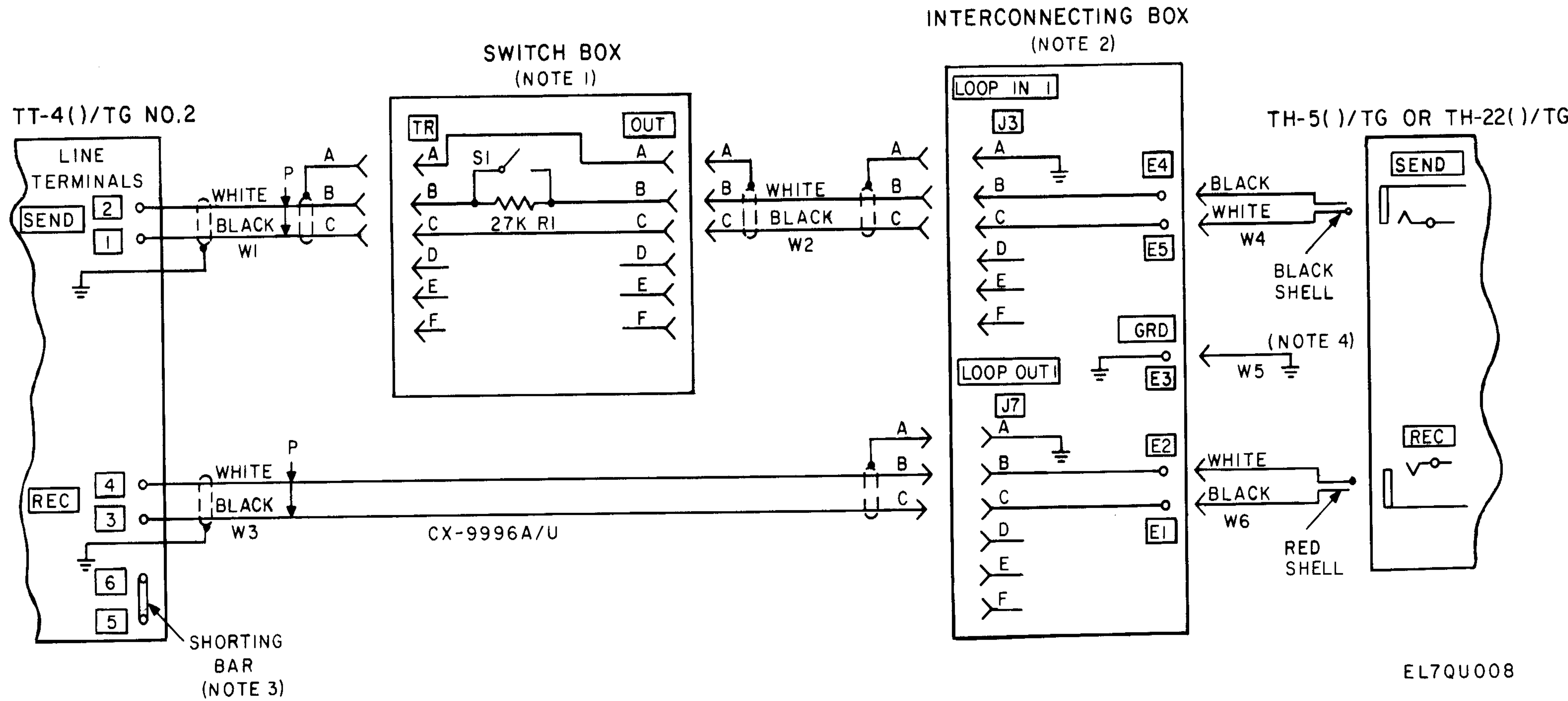

Figure 43. Modification of TT-76/GGC and TT-4/TG No. 1 cabling-schematic diagram.



EL7QU008

Figure 44. Modification of TT-4/TG No. 2 cabling-schematic diagram.

By Order of the Secretary of the Army:

Official:

ROBERT M. JOYCE  
*Brigadier General, United States Army*  
*The Adjutant General*

E. C. MEYER  
*General, United States Army*  
*Chief of Staff*

Distribution:

To be distributed in accordance with Special List.

CHANGE }  
No. 7 }

HEADQUARTERS,  
DEPARTMENT OF THE ARMY  
WASHINGTON, D. C., 20 February 1974

**Operator's, Organizational, Direct Support, General Support,  
and Depot Maintenance Manual  
Including Repair Parts and Special Tools Lists  
OPERATIONS CENTRAL AN/MSC-32**

TM 11-5895-224-15, 15 May 1961, is changed as follows:

Page 3, paragraph 2. Delete paragraph 2 and substitute:

**2. Forms and Records**

a. *Reports of Maintenance and Unsatisfactory Equipment.* Maintenance forms, records, and reports which are to be used by maintenance personnel at all maintenance levels are listed in and prescribed by TM 38-750.

b. *Report of Packaging and Handling Deficiencies.* Fill out and forward DD Form 6 (Report of Packaging and Handling Deficiencies) as prescribed in AR 700-58 (Army)/NAVSUP PUB 378 (Navy)/AFR 71-4 (Air Force)/MCO P4030.29 (Marine Corps), and DSAR 4145.8.

c. *Discrepancy in Shipment Report (DISREP) (SF 361).* Fill out and forward Discrepancy in Shipment Report (DISREP) (SF 361) as prescribed in AR 55-38 (Army)/NAVSUPINST 4610.33/AFM 75-18/MCO P4610.19A (Marine Corps), and DSAR 4500.15.

After paragraph 2 add:

**2.1. Reporting of Errors**

The reporting of errors, omissions, and recommendations for improving this publication by the individual user is encouraged. Reports should be submitted on DA Form 2028, Recommended Changes to Publications, and forwarded direct to Commander, US Army Electronics Command, ATTN: AMSEL-MA-C, Fort Monmouth, NJ 07703.

Page 4. After paragraph 4, add:

**4.1. Items Comprising an Operable Operations Central AN/MSC-32**

FSN	QTY	Nomenclature, part No., and mfr code	Fig. No.	Usable on code
5895-021-2090		Operations Central AN/MSC-32 consisting of: NOTE The part number is followed by the applicable cable 5-digit Federal supply code for manufacturers (FSCM) identified in SB 708-42 and used to identify manufacturer, distributor, or Government agency, etc.		
5965-682-2769	1	Handset-Headset H-144/U		
5815-503-2760	1	Reperforator-Transmitter, Teletypewriter TT-76/GCC or Reperforator-Transmitter, Teletypewriter TT-76A, B, C/GCC (FSN 5815-553-6061)		
5807-715-6171	1	Switchboard, Telephone, Manual SB-22/PT (Less cover)		
5805-543-0012	4	Telephone Set TA-312/PT	24	
5815-198-4438	2	Teletypewriter TT-4A/TG		

FSN	QTY	Nomenclature, part No., and mfr code	Fig. No.	Usable on code
5805-246-8734	3	Terminal, Telegraph TH-5/TG		
5410-752-9621	1	Shelter, Electrical Equipment S-184/MSC-32; S-184A, B, C, D/MSC-32 (S-141/G Shelter modified) which includes: NOTE In the usable on code column, number 1 refers to S-184/MSC-32, number 2 refers to S-184A/MSC-32, number 3 refers to S-184B/MSC-32; number 4 refers to S-184C/MSC-32; number 5 refers to S-184D/MSC-32.		
7520-753-4807	3	Basket, Wastepaper: 36; 85838	12	1, 2, 3, 4
7502-292-9493	3	Basket, Wastepaper: type II, style B gray; RR-B-181; 81349		5
6135-120-1020		Battery, Dry BA-30 NOTE Dry batteries shown are used with the equipment but are not considered part of the equipment. They will not be preshipped automatically but are to be requisitioned in quantities necessary for the particular organization, in accordance with SB 11-6.		1, 2, 3, 4, 5
7920-178-8315	1	Brush Dusting, Bench: SC-C-539469; 80063	14	1, 2, 3, 4, 5
5995-823-2715	1	Cable Assembly and Reel: Consists of CX-4566A/G, 250 ft lg, and Reel RC-435/U	3	1, 2, 3, 4, 5
5410-752-2435	1	Cable Assembly and Reel: Consists of CX-7453/U, 100 ft lg, and Reel RC-435/U	3	1, 2, 3, 4, 5
5995-752-2548	1	Cable Assembly, Power Electrical CX-7705/U: 15 ft lg power stub	2	1, 2, 3, 4, 5
4940-752-2474	1	Cable Assembly, Power Electrical: Line cord; SM-D-350987; 80063	2	1, 2, 3, 4, 5
5995-823-2620	1	Cable Assembly, Special Purpose: F/headset, SM-C-382135; 80063	2	1, 2, 3, 4, 5
5995-889-0803	1	Cable Assembly, Telephone CX-4760A/U: 15 ft lg	2	1, 2, 3, 4, 5
5995-752-2566	5	Cable Assembly, Telephone: F/LS-147C/FI and TA-312/PT; 4 ft lg; SM-D-383873-GR III; 80063	3	1, 2, 3, 4, 5
5995-889-0923	1	Cable Assembly, Telephone: F/SB-22/PT; SM-C-353715; 80063	23	1, 2, 3, 4, 5
5995-823-3016	2	Cable Assembly, Telephone: F/TTY; black plug; 6 ft lg; SM-D-384145-GR I; 80063	2	1, 2, 3, 4, 5
5995-889-0608	2	Cable Assembly, Telephone: F/TTY; ref plug; 6 ft lg; SM-D-384145-GR II; 80063	2	1, 2, 3, 4, 5
7105-943-3868	3	Chair, Folding: SC-D0539471; 80063	15	1, 2, 3, 4, 5
7110-273-8798	1	Chair, Rotary: (When replacing chair remove and retain mounting bracket for installation on new chair)	12	1, 2, 3, 4, 5
6645-800-7094	1	Clock, Aircraft, Mechanical: SC-C-539475; 80063	13	1
6645-303-4950	1	Clock, Aircraft, Mechanical: MIL-C-7939A, type AT-11, AN/5743-2; 81349; (When replacing retain mtg bkt for installing new clock)	13	2, 3, 5
6645-526-4395	1	Clock, Aircraft Mechanical: SM-B-472589-5; 80063, (When replacing retain mtg bkt for installing new clock)	13	4
6605-892-5399	1	Compass, Magnetic: MIL-C-10436; 81349	1	1, 2, 3, 4, 5
5995-752-2516	3	Cord Assembly, Electrical: 2 ft 6 in. lg; black; SM-D-352593-GR III; 80063	3	1, 2, 3, 4, 5
5995-752-2515	3	Cord Assembly, Electrical: 2 ft 6 in. lg; red; SM-D-352594-GR III; 80063	3	1, 2, 3, 4, 5
5995-752-2594	3	Cord Assembly, Electrical: 2 ft 6 in. lg; white; SM-D-352595-GR III; 80063	3	1, 2, 3, 4, 5
5995-752-2593	4	Cord Assembly, Electrical: 2 ft 6 in. lg; green; SM-D-352596-GR III; 80063	3	1, 2, 3, 4, 5
5995-752-2597	1	Cord Assembly, Electrical: 2 ft 6 in. lg; gray; SM-D-352597-GR III; 80063	3	1, 2, 3, 4, 5
7210-753-3043	3	Cushion, Chair: SM-C-350214; 80063	7	1, 2, 3, 4, 5
6110-649-8146	1	Distribution Box: J-1077A/U	13	1, 2, 3, 4, 5
5120-408-1481	1	Extractor, Electron Tube: F/7 pin; TP-11-16; 73917	14	1, 2, 3, 4, 5
5120-293-2692	1	Extractor, Electron Tube: F/9 pin; TP-13-16; 73917	14	1, 2, 3, 4, 5

FSN	QTY	Nomenclature, part No., and mfr code	Fig. No.	Usable on code
5120-776-9917	13	Grip, Cable, Jaw: approx 16 in. lg; EQA-6-8P; 95344	2	1, 2, 3, 4, 5
5120-776-9918	12	Grip, Cable, Jaw: approx 12 in. lg; EQA-26S; 95344	2	1, 2, 3, 4, 5
4520-224-7909	2	Heater, Space, Electrical: SC-D-539485; 80063	1	1, 2, 3, 4, 5
5830-752-5357	1	Intercommunication Station: LS-147C/FI	13	1, 2, 3, 4, 5
2540-892-6243	1	Ladder, Boarding, Vehicle; MX-3391/G	15	1, 2, 3, 4, 5
6230-729-9614	1	Lantern, Electrical: 21067; 32572	14	1, 2, 3, 4, 5
5410-752-2525	2	Lead, Electrical: SM-B-539592; 80063	2	1, 2, 3, 4, 5
6230-615-5384	1	Light, Extension: W-L-661, type 1, class 1; 81349	2	1, 2, 3, 4, 5
7510-240-1526	4	Pencil, Grease: Black	11	1, 2, 3, 4, 5
7510-436-5210	4	Pencil, Grease: Blue	11	1, 2, 3, 4, 5
7510-275-7212	4	Pencil, Grease: Green	11	1, 2, 3, 4, 5
7510-174-3205	4	Pencil, Grease: Red	11	1, 2, 3, 4, 5
7510-264-4662	4	Pencil, Grease: Yellow	11	1, 2, 3, 4, 5
5120-293-3603	1	Pin Straightener, Electron Tube: 8655; 72653		1, 2, 3, 4, 5
5120-752-9675	1	Screwdriver: 2143-6; 08600		1, 2, 3, 4, 5
7520-162-6178	1	Sharpener, Pencil: SC-C-539503; 80063	14	1, 2, 3, 4, 5
6210-752-8134	8	Shield, Light: SM-C-349983; 80063	7	1, 2, 3, 4, 5
5410-792-6336	6	Strap Assembly, Tie Down: FDC-1575101-1; 98313	2	1, 2, 3, 4, 5
5210-221-1882	1	Tape, Measuring: SV100G/0572; 86794		1, 2, 3, 4, 5
5805-503-3337	12	Telephone Circuit, Line Jack TA-222/PT		1, 2, 3, 4, 5
5805-715-6175	1	Telephone Circuit, Trunk Jack TA-326/PT		1, 2, 3, 4, 5
		ACCESSORIES		
7530-223-7966	1	Paper, Recording, Teletypewriter: UU-P-547C, type 1, class 1; 81349		1, 2, 3, 4, 5
7511-511-6690	1	Ribbon, Printing, Teletypewriter: DDD-R-311D, type 1, grade A, class 1; 81349		1, 2, 3, 4, 5
7530-634-6237	1	Tape, Teletypewriter: UU-T-120; 81349		1, 2, 3, 4, 5

## 4.2. Expendable Consumable Items

A list of expendable consumable items required for operation appears in table 1-1.

Table 1-1. Expendable Consumable Supplies and Material

The supplies and material listed in this table are required for operation of this equipment and are authorized to be requisitioned by SB 700-50. The FSN for the applicable unit of issue required can be found in appropriate supply catalogs. The FSCM is used as an element in item identification to designate manufacturer or distributor or Government agency, etc., and is identified in SB 708-42.

Item	Description	Ref. No. and FSCM	FSC
1	Pencil, Grease, Red		7510
2	Pencil, Grease, Black		7510
3	Pencil, Grease, Blue		7510
4	Pencil, Grease, Green		7510
5	Pencil, Grease, Yellow		7510
6	Paper, Recording, Teletypewriter, type 1, class 1	UU-P-547C; 81349	7530
7	Ribbon, Printing, Teletypewriter, type 1, grade A, class 1	DDD-R-311D; 81349	7511
8	Tape, Teletypewriter	UU-T-120; 81349	7530



## APPENDIX III BASIC ISSUE ITEMS LIST (BIIL) AND ITEMS TROOP INSTALLED OR AUTHORIZED LIST (ITIAL)

### Section I. INTRODUCTION

#### **A3-1. Scope.**

This appendix lists only basic issue items required by the crew/operator for installation, operation, and maintenance of Operations Center AN/MSC-32.

#### **A3-2. General.**

This Basic Issue Items and Items Troop Installed or Authorized List is divided into the following sections:

*a. Basic Issue Items List—Section II.* A list, in alphabetical sequence, of items which are furnished with, and which must be turned in with the end item.

*b. Items Troop Installed or Authorized List—Section III.* Not applicable.

#### **A3-3. Explanation of Columns.**

The following provides an explanation of columns found in the tabular listings:

*a. Illustration.* This column is divided as follows:

(1) *Figure number.* Indicates the figure number of the illustration in which the item is shown.

(2) *Item number.* Not applicable.

*b. Federal Stock Number.* Indicates the Federal stock number assigned to the item and will be used for requisitioning purposes.

*c. Part number.* Indicates the primary number used by the manufacturer (individual, company, firm, corporation, or Government activity), which controls the design and characteristics of the item by means of its engineering drawings, specifica-

tions standards, and inspection requirements, to identify an item or range of items.

*d. Federal Supply Code for Manufacturer (FSCM).* The FSCM is a 5-digit numeric code used to identify the manufacturer, distributor, or Government agency, etc., and is identified in SB 708-42.

*e. Description.* Indicates the Federal item name and a minimum description required to identify the item.

*f. Unit of Measure (UIM).* Indicates the standard of basic quantity of the listed item as used in performing the actual maintenance function. This measure is expressed by a two-character alphabetical abbreviation, (e.g., ea, in., pr, etc.). When the unit of measure differs from the unit of issue, the lowest unit of issue that will satisfy the required units of measure will be requisitioned.

*g. Quantity Furnished with Equipment (Basic Issue Items Only).* Indicates the quantity of the basic issue item furnished with the equipment.

#### **A3-4. Special Information.**

Usable on codes are included in the description column. Uncoded items are applicable to all models. Identification of the usable on codes are as follows:

Code	Used On
1	S-184/MSC-32
2	S-184A/MSC-32
3	S-184B/MSC-32
4	S-184C/MSC-32
	S-184D/MSC-32

## Section II. BASIC ISSUE ITEMS LIST

(1) Illustration		(2) Federal stock number	(3) Part number	(4) FSCM	(5) Description	USABLE ON CODE	(6) Unit of meas	(7) Qty Furn with equip
(A) Fig No.	(b) Item No.							
14		4210-727-8111	276	02461	AXE, PICKHEAD	1, 2, 3, 4	EA	1
14		5110-293-2339	GGG-A-926	81349	AXE, TYPE 1, CLASS 1, DESIGN B	5	EA	1
11		4210-383-7128	2-1/2 T2	33525	EXTINGUISHER, FIRE, 2-1/2 LB		EA	1
14		4210-383-7129	SC-D-539482	80063	EXTINGUISHER, FIRE, 5 LB		EA	1
14		6545-822-3166	SM-C-349935	80063	FIRST AID KIT	1	EA	1
14		6545-922-1200			FIRST AID KIT	1, 2, 3, 4	EA	1
		6645-633-9032	GG-K-392	81349	FIRST AID KIT, TYPE 2 SIZE 1	5	EA	1
14		5120-251-4489	15	79796	HAMMER, HAND		EA	1
14		5120-288-6563	AW-30	79796	HANDLE, HAMMER	1, 2, 3, 4	EA	1
		5975-224-5260			ROD, GROUND MX-148/G		EA	1

By Order of the Secretary of the Army:

**CREIGHTON W. ABRAMS**  
*General, United States Army*  
*Chief of Staff*

Official:

**VERNE L. BOWERS**  
*Major General, United States Army*  
*The Adjutant General*

Distribution:

*Active Army:*

USASA (2)	Army Dep (2) except
CNGB (1)	LBAD (14)
ACSC-E (2)	SAAD (30)
Dir of Trans (1)	TOAD (14)
COE (1)	ATAD (10)
TSG (1)	USA Dep (2)
USAARENBD (1)	Sig Sec USA Dep (2)
USAMB (10)	Sig Dep (2)
AMC (1)	Sig FLDMS (1)
TRADOC (2)	USAERDAW (1)
ARADCOM (2)	MAAG (1)
ARADCOM Rgn (2)	USARMIS (1)
OS Maj Comd (4)	Units org under fol TOE:
LOGCOMDS (3)	(1 copy each)
MICOM (2)	11-15
TECOM (2)	11-16
USACC (4)	11-17
MDW (1)	11-45
Armies (2)	11-46
Corps (2)	11-85
HISA (ECOM) (18)	11-86
Svc Colleges (1)	11-87
USASESS (10)	11-97
USAADS (2)	11-98
USAFAS (2)	11-116
USAARMS (2)	11-117
USAIS (2)	11-127
USAES (2)	11-158
USAINTS (3)	11-225
WRAMC (1)	11-226
USACDCEC (10)	11-247
ATS (1)	11-302
USAERDAA (1)	11-327
Instl (2) except	11-357
Fort Gordon (10)	11-500 AA-AC
Fort Huachuca (10)	29-134
Fort Carson (5)	29-136
Ft Richardson (ECOM Ofc) (2)	31-105
WSMR (1)	

NG: Three (3) cys to the fol States AG: FL, GA, IA, MA, MI, MD, OK, SC, UT, WI.

USAR: None

For explanation of abbreviations used, see AR 310-50.

CHANGE }  
No. 9 }HEADQUARTERS,  
DEPARTMENT OF THE ARMY  
WASHINGTON, DC 10 August 1983

# OPERATOR'S, ORGANIZATIONAL, DIRECT SUPPORT, GENERAL SUPPORT, AND DEPOT MAINTENANCE MANUAL INCLUDING REPAIR PARTS AND SPECIAL TOOLS LISTS OPERATIONS CENTRAL AN/MSC-32 (NSN 5895-00-021-2090)

TM 11-5895-244-15, 15 May 1961, is changed as follows:

*Page 3.* Paragraph 1.1, change paragraph heading to: Consolidatd Index of Army Publications and Blank Forms. In first sentence change "310-4" to "310-1".

*Page 3.* Paragraph 2.1 is Superseded as follows:

## 2.1 Reporting Errors and Recommending Improvements

can help improve this manual. If you find any mistakes you know of a way to improve the procedures, please let us know. Mail your letter or DA Form 2028 (Recommended Changes to Publications and Blank Forms) direct to: Commander, US Army Communications-Electronics Command and Fort Monmouth, ATTN: DRSEL-ME-MP, Fort Monmouth, New Jersey 07703.

*Page 3.* Paragraph 2-4 is superseded as follows:

## 2.4 Reporting Equipment Improvement Recommendations (EIR)

If your Operations Central AN/MSC-32 needs improvement, let us know. Send us an EIR. You, the user, are the only one who can tell us what you don't like about your equipment. Let us know why you don't like the design. Put it on an SF 368 (Quality Deficiency Report). Mail it to Commander, US Army Communications-Electronics Command and Fort Monmouth, ATTN: DRSEL-ME-MP, Fort Monmouth, New Jersey 07703. We'll send you a reply.

*Page 29.* Paragraph 19. Delete subparagraph *b* and substitute:

*b. Securing AN/MSC-32 on Truck* (fig. 26).

- (1) Install the tiedown ring assembly (A, fig. 26)

part of the sling assembly) above the center support on the cargo bed side rail of the truck.

- (2) Use the hook at the end farthest from the turnbuckle and hook each of the sling assemblies to a tiedown eye of the shelter.
- (3) Secure the sling hooks to the tiedown ring (B, fig. 26).
- (4) Follow the procedures given in (1) through (3) above to secure the other side of the shelter.
- (5) Tighten all turnbuckles evenly by hand; then turn each turnbuckle an additional one-half turn with a bar or rod inserted in the turnbuckle slot.

## CAUTION

Do not overtighten the turnbuckles.

- (6) Raise and secure the truck tailgate.

Delete figure 26 and substitute the new figure 26.

*Page 39.* Change the title of "Section I" to OPERATOR'S AND ORGANIZATIONAL PREVENTIVE MAINTENANCE.

*Page 39.* Paragraph 30. Delete paragraph 30 and substitute:  
30. General

## NOTE

Refer to TM 750-244-2 for proper procedures for destruction of this equipment to prevent enemy use.

*a.* Operator/crew preventive maintenance is the systematic care, servicing and inspection of equipment to pre-

\* This change supersedes TM 11-5895-224 ESC, 16 Jun 75 and C3, 11 July 63.

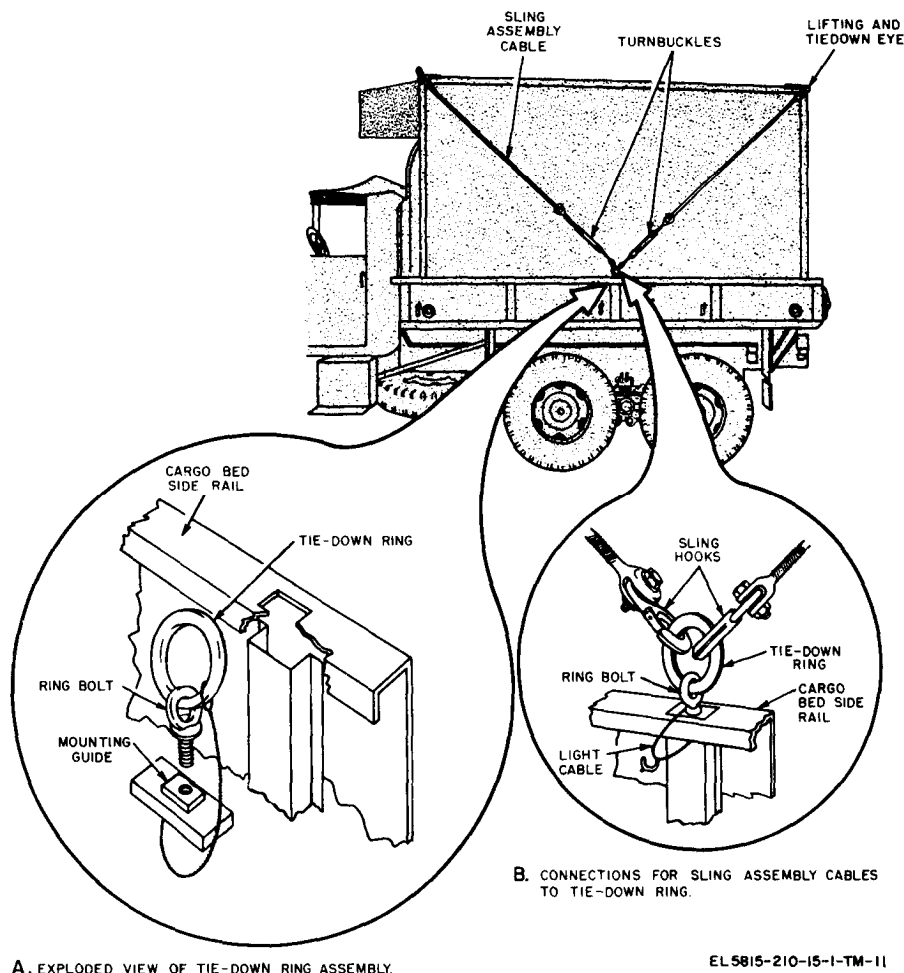

Figure 26. Tiedown ring assembly and sling assembly connection diagram, exploded view

vent the occurrence of trouble, to reduce downtime, and to maintain equipment in serviceable condition. To be sure that your operations central is always ready for your mission, you must do scheduled preventive maintenance checks and services (PMCS).

(1) BEFORE OPERATION, perform your B PMCS to be sure that your equipment is ready to go.

(2) When an item of equipment is reinstalled after removal, for any reason, perform the necessary B PMCS to be sure the item meets the readiness reporting criteria.

(3) Use the ITEM NO. column in the PMCS table to get the number to be used in the TM ITEM NO. column on DA Form 2404 (Equipment Inspection and Maintenance Worksheet) when you fill out the form.

b. Organizational preventive maintenance procedures are designed to help maintain equipment in serviceable condition. They include items to be checked and how to check them. These checks and services, described in paragraph 33,

outline inspections that are to be made at specific monthly (M) intervals.

c. Routine checks like CLEANING, LUBRICATION, DUSTING, WASHING, CHECKING FOR FRAYED CABLES, STOWING ITEMS NOT IN USE, COVERING UNUSED RECEPTACLES, CHECKING FOR LOOSE NUTS AND BOLTS AND CHECKING FOR COMPLETENESS are not listed as PMCS checks. They are things that you should do any time you see they must be done. If you find a routine check like one of those listed in your PMCS, it is because other operators reported problems with this item.

**NOTE**

When you are doing any PMCS or routine checks, keep in mind the warnings and cautions.

**WARNINGS**

Never operate the generator or shelter until it has been properly grounded. Electrical defect

in the load lines or equipment can cause death by electrocution when contact is made with an ungrounded system.

Adequate ventilation should be provided while using TRICHLOROTRIFLUOROETHANE. Prolonged breathing of vapor should be avoided. The solvent should not be used near heat or open flame; the products of decomposition are toxic and irritating. Since TRICHLOROTRIFLUOROETHANE dissolves natural oils, prolonged contact with skin should be avoided. When necessary, use gloves which the solvent cannot penetrate. If the solvent is taken internally, consult a physician immediately.

Compressed air is dangerous and can cause serious bodily harm if protective means or methods are not observed to prevent a chip or particle (of whatever size) from being blown into the eyes or unbroken skin of the operator or other personnel. Goggles must be worn at all times while cleaning with compressed air. Compressed air shall not be used for cleaning purposes except where reduced to less than 29 pounds per square inch gage (psig) and then only with effective chip guarding and personnel protective equipment. Do not use compressed air to dry parts when trichlorotrifluoroethane has been used.

**NOTES**

The PROCEDURES column in your PMCS charts

B - Before

M - Monthly

Item No.	Interval	Item to be Inspected	Procedures: Check for and have repaired or adjusted as necessary	Equipment is Not Ready/Available if:
	B			
1	●	Completeness	Check for completeness.	Major operating component is missing.
2	●	Exhaust Blowers	Check operation.	One or more blowers inoperative.
3	*	Manual Telephone Switchboard SB-22/PT, SB-22A/PT	Perform operational checks as described in TM 11-5805-262-12.	Switchboard inoperative or four or more linepacks inoperative.
4	*	Teletypewriter (two) TT-4A/TG, TT-4B/TG	Perform operational checks as described in TM 11-5815-206-12.	Teletypewriters cannot communicate.
5	*	Teletypewriter Reperforator-Transmitter	Perform operational checks as described in TM 11-2225.	Fails to feed tape or tears tape.

\*Do this check before each deployment to a mission location. This will permit any existing problems to be corrected before the mission starts. The check does not need to be done again until redeployment.

instruct how to perform the required checks and services. Carefully follow these instructions and, if tools are needed or the chart so instructs, get organizational maintenance to do the necessary work.

If your equipment must be in operation all the time, check those items that can be checked and serviced without disturbing operation. Make the complete checks and services when the equipment can be shut down.

d. Deficiencies that cannot be corrected must be reported to higher category maintenance personnel. Records and reports of preventive maintenance must be made in accordance with procedures given in TM 38-750.

Page 39. Paragraphs 31 and 32. Delete paragraphs 31 and 32 and substitute:

**31. Operator/Crew Preventive Maintenance Checks and Services**

Perform before operation PMCS if you are operating the item for the first time.

**NOTE**

The checks in the interval column are to be performed in the order listed.

**32. Operator/Crew Preventive Maintenance Checks and Service Chart**

B - Before M - Monthly

Item No.	Interval	Item to be Inspected	Procedures: Check for and have repaired or adjusted as necessary	Equipment is Not Ready/Available if:
	B			
6	*	TT-76/GGC, TT-76A/GGC, TT-76B/GGC.	Perform operational checks as described in TM 11-5805-201-12.	Constant ring.
7	*	Telephone Set TA-312/PT (three) Telegraph Terminal (three) TH-5/TG	Perform operational checks as described in TM 11-5805-246-10.	

\*Do this check before each deployment to a mission location. This will permit any existing problems to be corrected before the mission starts. The check does not need to be done again until redeployment.

Page 40. Paragraph 33. Delete paragraph 33 and substitute.

**33. Organizational Preventive Maintenance Checks and Services Chart**

M - Monthly

Item No.	Interval	Item to be Inspected	Procedures
	M		
1	●	Telegraph Terminal TH-5	Perform operational checks as described in TM 11-5805-246-20.
2	●	Grounding System	Check grounding system to insure safety (TB 43-0125).

Page 40. Paragraph 34. Delete paragraph 34.

Page 52. Paragraph 54b, line 4. Delete "Patch Wet, Shelter, Electrical Equipment," and substitute: Repair Kit, Electrical Equipment Shelter MK-680/G.

Page 57. Delete Section II.

Page 58. Appendix I. Delete appendix I and substitute:

**APPENDIX I  
REFERENCES**

The following references are applicable for the operator and repair technician of Operations Central AN/MS-32:

- DA Pam 310-1 Consolidated Index of Army Publications and Blank Forms.
- SB 11-6 Primary Battery Supply Data.
- SB 11-573 Painting and Preservation Supplies Available for Field Use for Electronics Command Equipment.
- TB 11-6625-666-50 Inspection Requirements for Repaired Electrical Indicating Instruments.

TB 43-0118	Field Instructions for Painting and Preserving Electronics Command Equipment Including Camouflage Pattern Painting of Electrical Equipment Shelters.
TB 11-6625-666-50	Inspection Requirements for Repaired Electrical Indicating Instruments.
TB 43-0124	Maintenance and Repair Procedure for Shelters, Electrical Equipment S-141/(G and S-141B/G (NSN 5410-00-752-9698), S-144G, S-144A/G, S-144B/G, S-144C/G and S-144D/G (5410-00-542-2532), S-250/G (5410-00-999-4935), S-250/G (Shielded) (5410-00-489-6076), S-280/G (5410-00-999-5269), S-280A/G (5410-00-999-6022), S-280B/G (5410-00-117-2868), S-280B/G (Shielded) (5410-00-001-4093) and S-280C/G, S-318/G (5410-00-763-2339) and S-318A/G (5410-00-116-7086).
TM 11-2138	Terminal Box TA-125/GT; Telephone Repeating Coil Assembly TA-145/GT; Maintenance Kit MX-842/GT; and Switchboard Signal TA-123/GT.
TM 11-5410-206-14P	Operator's, Organizational, Direct Support and General Support Maintenance Repair Parts and Special Tools List (Including Depot Maintenance Repair Parts and Special Tools): Shelters, Electrical Equipment, S-141/G and S-141B/G.
TM 11-5805-201-12	Operator and Organizational Maintenance Manual: Telephone Set TA-312/PT (NSN 5805-00-543-0012).
TM 11-5805-201-20P	Organizational Maintenance Repair Parts and Special Tool Lists: Telephone Set TA-312/PT (NSN 5805-00-543-0012).
TM 11-5805-201-35	Direct Support, General Support, and Depot Maintenance Manual Including Repair Parts and Special Tool Lists: Telephone Set TA-312/PT (NSN 5805-00-543-0012).
TM 11-5805-201-34P	Direct Support and General Support Maintenance Repair Parts and Special Tools Lists (Including Depot Maintenance Repair Parts and Special Tools) for Telephone Set TA-312/PT (NSN 5805-00-543-0012).
TM 11-5805-246-10	Operator's Manual: Terminal, Telegraph TH-5/TG.
TM 11-5805-246-20	Organizational Maintenance Manual: Terminal, Telegraph TH-5/TG.
TM 11-5805-246-20P	Organizational Maintenance Repair Parts and Special Tools Lists: Terminals, Telegraph TH-5/TG (FSN 5805-246-8734) and TH-5A/TG (5805-020-5720).
TM 11-5805-246-35	Direct Support, General Support, and Depot Maintenance Manual: Terminal, Telegraph TH-5/TG.
TM 11-5805-246-34P	Direct Support and General Support Maintenance Repair Parts and Special Tools Lists (Including Depot Maintenance Repair Parts and Special Tools Lists): Terminals, Telegraph, TH-5/TG (FSN 5805-246-8734) and TH-5A/TG (5805-020-5720).
TM 11-5805-262-12	Operator's and Organizational Maintenance Manual: Switchboards, Telephone, Manual SB-22/PT (NSN-5805-00-257-3602) and SB-22A/PT (5805-00-715-6171) and Adapter, Tone Signaling, TA-977/PT (5805-01-040-9653).
TM 11-5805-262-20P	Organizational Maintenance Repair Parts and Special Tool Lists: Switchboards, Telephone, Manual SB-22/PT (NSN 5805-00-257-3602) and SB-22A/PT (5805-00-715-6171).
TM 11-5805-262-35	Direct Support, General Support, and Depot Maintenance Manual: Switchboards, Telephone, Manual SB-22/PT (NSN 5805-00-257-3602) and SB-22A/PT (5805-00-715-6171).



- TM 11-5805-262-34P Direct Support and General Support Maintenance Repair Parts and Special Tools Lists (Including Depot Maintenance Repair Parts and Special Tools) for Switchboards, Telephone, Manual SB-22/PT (NSN 5805-00-257-3602) and SB-22A/PT (5805-00-715-6171).
- TM 11-5805-354-24P Organizational, Direct Support and General Support Maintenance (Repair and Special Tools): Terminal Box, TA-125/GT (FSN 5805-538-0777).
- TM 11-5810-221-12P Operator's and Organizational Maintenance Repair Parts and Special Tools Lists Including Maintenance Allocation Chart: Communications Security Equipment TSEC/KW-7, TSEC/KW-7 with KWX-10/TSEC (NSN 5810-00-998-5760).
- TM 11-5810-221-34P Direct Support and General Support Maintenance Repair Parts and Special Tools List (Including Depot Maintenance Repair Parts and Tools) for Communications Security Equipment, TSEC/KY-8 (NSN 5810-00-007-7951).
- TM 11-5815-206-ESC Equipment Serviceability Criteria: Teletypewriter Set AN/PGC-1 and Teletypewriters TT-4A/TG, TT-4B/TG, TT-4C/TG, and TT-335/TG.
- TM 11-5815-206-12 Operator's and Organizational Maintenance Manual for Teletypewriter Sets, AN/PGC-1 and AN/PGC-3 and Teletypewriters TT-4A/TG, TT-4B/TG, TT-4C/TG, TT-335/TG, TT-537/TG, TT-698/TG, TT-698A/TG, TT-698B/TG, TT-722/TG and TT-722A/TG.
- TM 11-5815-206-20P Organizational Maintenance Repair Parts and Special Tools List for Teletypewriter Sets, AN/PGC-1 (NSN 5815-00-198-5963), AN/PGC-3 (5815-01-012-8773) Teletypewriters, TT-4A/TG, TT-4B/TG, and TT-4C/TG (5815-00-198-4438), TT-335/TG (5815-00-878-8449), TT-537/TG(5815-00-926-7378), TT-698/TG, TT-698A/TG, TT-698B/TG, (5815-01-008-9628) and TT-722/TG, TT-722A/TG (5815-01-017-9172).
- TM 11-5815-206-34 Direct Support and General Support Maintenance Manual: Teletypewriter Sets AN/PGC-1 (NSN 5815-00-198-5963), AN/PGC-3 (5815-00-012-8773), and Teletypewriters TT-4A/TG, TT-4B/TG, TT-4C/TG (5815-00-198-4438), TT-335/TG (5815-00-878-8449), TT-537/G (5815-00-926-7378), TT-698/TG, TT-698A/TG, TT-698B/TG (5815-01-008-9628) TT-722/TG, TT-722A/TG (5815-01-017-9172).
- TM 11-5815-206-34P-1 Direct Support and General Support Maintenance Repair Parts and Special Tools List (Including Depot Maintenance Repair Parts and Special Tools) for Teletypewriter Sets, AN/PGC-1 (NSN 5815-00-198-5963), AN/PGC-3 (5815-01-012-8773); Teletypewriters, TT-4A/TG, TT-4B/TG, TT-4C/TG (5815-00-198-4438), TT-698/TG, TT-698A/TG, TT-698B/TG (5815-01-008-9628) and TT-722/TG, TT-722A/TG (5815-01-017-9172).
- TM 11-5815-206-34P-2 Direct Support and General Support Maintenance Repair Parts and Special Tools Lists (Including Depot Maintenance Repair Parts and Special Tools) for Teletypewriter TT-335/TG (NSN 5815-00-878-8449).
- TM 11-5815-238-12 Operator's and Organizational Maintenance Manual: Teletypewriter Sets, AN/GGC-3 (NSN 5815-00-503-3309), AN/GGC-3A (5815-00-581-9751), AN/GGC-53 (5815-01-012-8772) and AN/GGC-53A (5815-01-017-0956) and Teletypewriter Reperator. Transmitters, TT-76/GGC (5815-00-503-2760), TT-76A/GGC, TT-76B/GGC, TT-76C/GGC (5815-00-553-6061), TT-699/GGC (5815-01-012-8446), TT-699A/GGC TT-699B/GGC and TT-699C/GGC (5815-01-017-9166).

TM 11-5815-238-35	Direct Support, General Support, and Depot Maintenance Manual: Teletypewriter Sets, AN/GGC-3 (NSN 5815-00-503-3309), AN/GGC-3A (5815-00-581-9751), AN/GGC-53 (5815-01-012-8772) and AN/GGC-53A (5815-01-017-0956) and Teletypewriter Reperforator-Transmitters, TT-76/GGC (5815-00-503-2760), TT-76A/GGC, TT-76B/GGC, and TT-76C/GGC (5815-00-553-6061), TT-699/GGC (5815-01-012-8446), TT-699A/GGC, TT-699B/GGC, and TT-699C/GGC (5815-01-017-9166).
TM 11-5815-238-34P	Direct Support and General Support Maintenance Repair Parts and Special Tools Lists (Including Depot Maintenance Repair Parts and Special Tools): Teletypewriter Sets AN/GGC-3 (NSN 5815-00-503-3309), AN/GGC-3A (5815-00-581-9751), AN/GGC-53 (5815-00-012-8772), and AN/GGC-53A (5815-01-017-0956) and Teletypewriter Reperforator-Transmitters TT-76/GGC (5815-00-503-2760), TT-76A/GGC (5815-00-553-6061), TT-76B/GGC (5815-00-553-6061), TT-76C/GGC (5815-00-503-2760), TT-699/GGC (5815-01-012-8446), TT-699A/GGC (5815-01-017-9166), TT-699B/GGC (5815-01-017-9166) and TT-699C/GGC (5815-01-017-9166).
TM 11-5830-221-12	Operator's and Organizational Maintenance Manual: Intercommunication Stations LS-147A/FI, LS-147B/FI, LS-147C/FI, and LS-147D/FI (NSN 5830-00-752-5357).
TM 11-5830-221-24P	Organizational, Direct Support, and General Support Maintenance Repair Parts and Special Tools Lists for Telecommunication Station LS-147C/FI (NSN 5830-00-752-5357).
TM 11-5830-221-35	Field and Depot Maintenance Manual: Intercommunication Stations LS-147A/FI, LS-147B/FI, LS-147C/FI, and LS-147D/FI.
TM 11-5965-206-14P	Operator's, Organizational, Direct Support and General Support Maintenance Repair Parts and Special Tools Lists (Including Depot Maintenance Repair Parts and Special Tools), Headset Microphone H-91A/U (FSN 5965-669-6871), Handset Headset H-144/U, H-144A/U, H-144B/U and H-144C/U (FSN 5965-682-2769) and Headset-Microphone H-210/G (FSN 5965-892-1068).
TM 11-5965-224-14P	Operator's, Organizational, Direct Support and General Support Maintenance Repair Parts and Special Tools List (Including Depot Maintenance Repair Parts and Special Tools) Handsets, H-60/PT (FSN 5965-669-9145) and H-165/U (5965-543-1837).
TM 11-5965-271-50	Depot Maintenance Manual: Handsets TS-9-(*), TS-10-(*), TS-11-(*), TS-12-F, TS-13-(*), TS-14-(*), TS-15-(*), H-22-B/U, H23-(*U), and H-60/PT.
TM 11-6105-200-50	Depot Maintenance Manual for Fractional Horsepower Motors.
TM 11-6110-201-12P	Operator's and Organizational Maintenance Repair Parts and Special Tools Lists for Distribution Boxes J-1077/U and J-1077A/U (NSN 6110-00-985-7574).
TM 11-6110-201-34P	Direct Support and General Support Maintenance Repair Parts and Special Tools Lists (Including Depot Maintenance Repair Parts and Special Tools) for Distribution Boxes J-1077/U and J-1077A/U (NSN 6110-00-985-7574).

**C9, TM 11-5895-224-15**

TM 11-6625-203-12	Operator's and Organizational Maintenance Manual: Multimeter AN/URM-105 and AN/URM-105C (Including Multimeter ME-77/U and ME-77C/U).
TM 38-750	The Army Maintenance Management System (TAMMS).
TM 43-0139	Painting Instructions for Field Use.
TM 740-90-1	Administrative Storage of Equipment.
TM 750-244-2	Procedures for Destruction of Electronics Material to prevent Enemy Use.

By Order of the Secretary of the Army:

JOHN A. WICKHAM, JR.  
*General, United States Army*  
*Chief of Staff*

Official:

ROBERT M. JOYCE  
*Major General, United States Army*  
*The Adjutant General*

DISTRIBUTION:

To be distributed in accordance with Special List.

TECHNICAL MANUAL }  
 No. 11-5895-224-15 }

HEADQUARTERS,  
 DEPARTMENT OF THE ARMY  
 WASHINGTON 25, D. C., 15 May 1961

OPERATIONS CENTRAL AN/MSC-32

---

			Paragraph	Page
CHAPTER	1.	INTRODUCTION		
	Section I.	General -----	1,2	3
	II.	Description and data -----	3-8	3-19
C HAPTER	2.	INSTALLATION AND PREOPERATIONAL PROCEDURES		
	Section I.	Installation, connection, and testing of installed equipment -----	9-17	20-27
	II.	Preoperational procedures -----	18-21	27-31
	III.	Signal connections -----	22, 23	31, 32
CHAPTER	3.	OPERATING INSTRUCTIONS -----	24-29	33-38
C HAPTER	4.	MAINTENANCE INSTRUCTIONS		
	Section I.	Operator's maintenance -----	30-45	39-44
	II.	Organizational, field, and depot maintenance -----	46-54	44-53
CHAPTER	5.	THEORY -----	55,56	54, 55
C HAPTER	6.	SHIPMENT AND LIMITED STORAGE AND DEMOLITION TO PREVENT ENEMY USE		
	Section I.	Shipment and limited storage -----	57,58	56
	II.	Demolition of materiel to prevent enemy use -----	59,60	57
APPENDIX	I.	REFERENCES -----		58-61
	II.	MAINTENANCE ALLOCATION -----		62-67
	III.	BASIC ISSUE ITEMS LIST -----		60-72
Index		-----		73-75

# CHAPTER 1

## INTRODUCTION

---

### Section I. GENERAL

#### I. Scope

a. This manual describes Operations Central AN/MSC-32 and covers its installation, operation, theory, and maintenance. It also includes instructions for installing components not provided as part of Shelter, Electrical Equipment S-184/MSC-32 (fig. 5). Except for the shelter and its components, major components of the AN/MSC-32 are covered in detail in their respective manuals (appx I).

b. Official nomenclature followed by (\*) is used to indicate all models of the equipment covered in this manual. Thus, Switchboard, Telephone, Manual SB-22(\*)/PT represents Switchboards, Telephone, Manual SB-22/PT and SB-22A/PT; Reperforator-Transmitter, Teletypewriter TT-76(\*)/GGC represents Reperforator-Transmitters, Teletypewriter TT-76/GGC, TT-76A/GGC, and TT/76B/GGC; Intercommunication Station LS-147(\*)/FI represents Intercommunication Stations LS-147A/FI, LS-147B/FI, LS-147C/FI, and LS-147D/FI; Teletypewriter TT-4(\*)/TG represents Teletypewriters TT-4A/TG and TT-4B/TG.

#### 2. Forms and Records

a. *Unsatisfactory Equipment Report.* Fill out and forward DA Form 468 (Unsatisfac-

tory Equipment Report) on DD Form 787-1 (Electronic Equipment Report--Signal Equipment) to the Commanding Officer, U. S. Army Signal Materiel Support Agency, ATTN: SIGMS-ML, Fort Monmouth, N. J., as prescribed in AR 700-38 (for DA Form 468) and in AR 700-39 (For DD Form 787-1).

b. *Report of Damaged or Improper Shipment.* Fill out and forward DD Form 6 (Report of Damaged or Improper Shipment), as prescribed in AR 700-58.

c. *Preventive Maintenance Forms.* Prepare preventive maintenance forms for the major components of Operations Central AN/MSC-32, as specified in their respective technical manuals (appx I).

d. *Parts List Form.* Forward DA Form 2028 (Recommended Changes to DA Technical Manual Parts Lists or Supply Manual 7, 8, or 9) direct to the Commanding Officer, U. S. Army Signal Materiel Support Agency, ATTN: SIGMS-ML, Fort Monmouth, N. J., with comments on parts listings in appendixes II and III.

e. *Comments on Manual.* Forward all other comments on this publication direct to the Commanding Officer, U. S. Army Signal Materiel Support Agency, ATTN: SIGMS-PA2d Fort Monmouth, N. J.

### Section II. DESCRIPTION AND DATA

#### 3. Purpose and Use

Operations Central AN/MSC-32 (para 5) is an air- or vehicular-transportable field communication operations office. The AN/MSC-32 contains telephone switchboard, teletypewriter, and local telephone circuits (fig. 1). Display

board facilities required by the signal operations officer to plan, engineer, and control an area-type communication system are provided. The AN/MSC-32 is normally used with Operations Center, Communications AN/MSC-81 at corps and army signal centers.

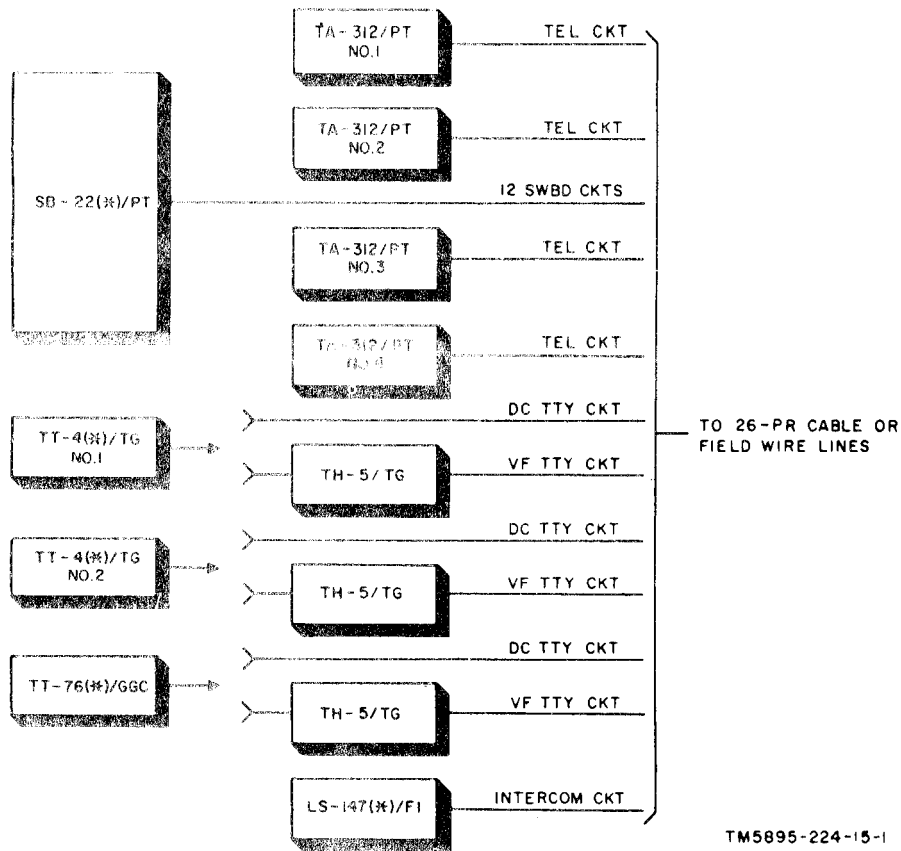

Figure 1. Operations Central AN/MS-32, signal circuits, block diagram.

#### 4. Technical Characteristics

Power requirements . . . . .115 vac, 60 cps,  
1-phase,  
3-wire.

Power consumption (max):  
Lights . . . . .310 w.  
Exhaust blowers . . . . .300 w.  
Electric heaters . . . . .3,000 w.

#### Equipment:

Terminals, Telegraph  
TH-5/TG (3) . . . 180 w.  
Teletypewriters TT-  
4(\*)/TG (2) . . . . .320 w.  
Reperforator-Transmit-  
ter, Teletypewriter  
TT-76(\*)/GGC. . . . .150 w.  
Intercommunication Sta-  
tion LS-147(\*)/FI . . . 32 w.  
Total . . . . .4,292

#### Communication facilities:

Telephone  
(TA-312/PT) . . . 4 circuits.  
Switchboard  
(SB-22 (\*) /PT) . . . . .12 circuits.  
Intercommunication  
(LS-147(\*)/FI) . . . 1 circuit.  
Teletypewriter  
(TT-4 (\*) /TG,  
TT-76(\*)/GGC) . . . 3 circuits.

#### Weight:

AN/MS-32 . . . . .2,761 lb.  
S-184/MS-32 . . . . .1,200 lb.

#### Outside dimensions of shelter:

Length . . . . .138 in.  
Width . . . . .80 in.  
Height . . . . .77½ in.

## 5. Components

### a. Major Components.

Quantity (ea)	Item	Figure No.
1	Switchboard, Telephone, Manual SB-22(*)/PT	13
1	Shelter, Electrical Equipment S-184/MSC-32 (b below)	
3.	Terminal, Telegraph TH-5/TG	13
4	Telephone Set TA-312/PT (3 in storage cabinet)	11
2	Teletypewriter TT-4(*)/TG	13
1	Reperforat -Transmitter, Teletypewriter T-76(*)/GGC	13
1	Terminal Box TA-125/GT (in cabinet No. 11)	12

### b. Shelter Components.

Quantity (ea)	Item	Figure No.
1	Axe	14
1	Blackout curtain assembly	14
1	Cable Assembly, Telephone CX-4566/G (250 ft ) with Reel RC-435/U	3
1	Cable stub, SB-22/PT (3-ft)	23
1	Cable stub, power (15 ft) (cabinet No. 6)	2
1	Cable Assembly, Telephone CX-4760/U (15 ft) (cabinet No. 6)	2
1	Chad bin	13
1	Clock, 8-day	13
1	Cord, audio, 8 ft	
3	Cushion, foam	7
2	Desk tray	13, 14
1	Distribution Box —1077A/U	13
1	Drain plug wrench	15
1	Droplight (25 ft) (cabinet No. 2)	2
2	Exhaust blower	13
2	Electric heater	12, 13, 17

Quantity (ea)	Item	Figure No.
1	Fire extinguisher, 2½ lb	11
1	Fire extinguisher, 5 lb	14
1	First aid kit	14
3	Folding chair	15
10	Grease pencil (5 colors)	11, 12
2	Ground rod	14
2	Ground strap (cabinet No. 1)	2
1	Hand brush	14
1	Hand lantern	14
	Hardware (in 5 bags)	2
1	Intercommunication Station I. S-147(*)/FI	13, 18
1	Ladder assembly	15
1	Line cord (15 ft), with duplex receptacle (cabinet No. 5)	2
1	Operations board	11
3	Patch cord, black, 2-ft (cabinet No. 4)	3
3	Patch cord, red, 2 ft (cabinet No. 4)	3
3	Patch cord, white, 2 ft (cabinet No. 4)	3
3	Patch cord, green, 2 ft (cabinet No. 4)	3
3	Patch cord, gray, 2 ft (cabinet No. 4)	3
1	Patch panel	13
1	Pencil sharpener	14
1	Power cable assembly (100 ft) with reel	3
12	Power cable grip	2
1	Power distribution panel	10, 14
1	Shelter, Electrical Equipment S-141/G (modified)	5
13	Signal cable grip	2
1	Sledge hammer	14
1	Sledge hammer handle, spare	14
1	String assembly	15, 26
2	Spotlight	16
1	Status board	12



Quantit (ea)	Item	Figure No.
1	Swivel chair	12
1	Cape basket	12
5	Telephone connecting cord, 4 ft	2
2	Teletypewriter connecting cord, black 6 ft	2
2	Teletypewriter connecting cord, red, 6 ft	2
1	Teletypewriter patch panel	13
6	Tiedown strap	2
1	Tool roll kit including:	2
	1 bag with 10 pockets	
	1 adjustable wrench, 8 in.	
	1 Allen wrench set	
	1 Knife TL-29	
	1 lineman's pliers	
	1 long-nosed pliers	
	1 screwdriver, 2 in.	
	1 screwdriver, 4 in.	
	1 screwdriver, 6 in.	
	1 socket wrench set	
	1 vise-grip pliers, 7 in.	
1	Tube pin straightener	14
1	Tube puller, 7 pins	14
1	Tube puller, 9 pins	14
2	Wastebasket	12
1 set	Technical manuals for major components (para 5)	
1 set	Running spares including:	4.
	2 fluorescent lamps, 20 w (24 in.) (fig. 16)	
	6 fluorescent lamp starters FS-2 (fig. 16)	
	3 glowlamps, NE-45 (cabi- net No. 1)	
	2 incandescent lamps, 50 w (cabinet No. 1)	
	1 POWER INDICATOR NEON LAMP, NE-34 (cabinet No. 1)	

## 6. Description of Operations Central AN/MSC-32

The components of Operations Central AN/ MSC-32 (para 5) are housed in Shelter, Electrical Equipment S-184/MSC-32 (fig. 5). External connections (cable and field wire) are made either at the binding post signal entrance box or at the power and signal entrance box. Alternating-current (ac) power for the shelter must be obtained from a nearby shelter or other local source. Figures 6 and 7 are interior views of the AN/ MSC-32; the location of interior components are shown in figures 11 through 16. The major components of the AN/ MSC-32 are described in paragraph 7 and the shelter components in paragraph 8.

## 7. Description of Major Components of AN/ MSC-32

*a. Shelter, Electrical Equipment S-184/ MSC-32* (fig. 5 and 23). The shelter is a component of the AN/ MSC-32 in which all other components (para 5) are installed. All equipment racks and mountings, ac power receptacles, and signal wiring required for mounting and operating the AN/ MSC-32 components are installed in the shelter. Storage areas and installed mounting fixtures are provided for running spares and accessory items. The shelter can be transported by helicopter or truck and is fully insulated, watertight, and airtight. Two lightweight exhaust blower vents, equipped with hinged covers and rain shields (not shown), are on the outside front wall. A two-section door at the rear permits entrance to the shelter. The upper section of the door is used when the AN/ MSC-32 is truck-mounted and the tailgate is up.

- (1) *Lighting.* Eight fluorescent light fixtures, installed in the ceiling (fig. 16), provide lighting for the shelter. A nightlight is mounted near the teletypewriter patch panel (fig. 13).
- (2) *Entrance boxes.* The power and signal entrance box (fig. 8) and the binding post signal entrance box (fig. 9) are mounted in the exterior wall of the shelter (fig. 5). Each entrance box cover is equipped with

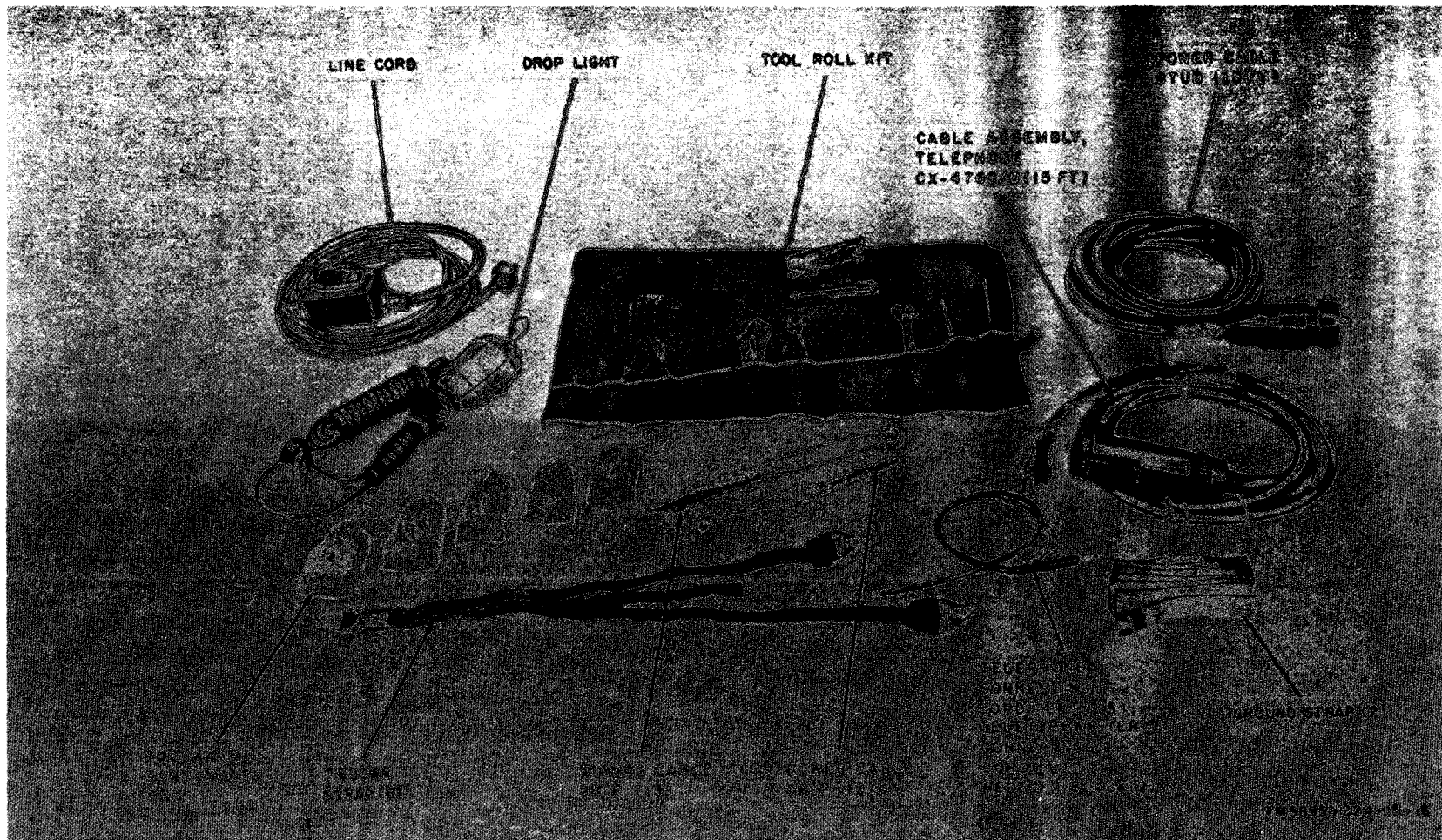

Figure 2. Shelter, Electrical Equipment, S-184/MSC-32, tools and accessories.

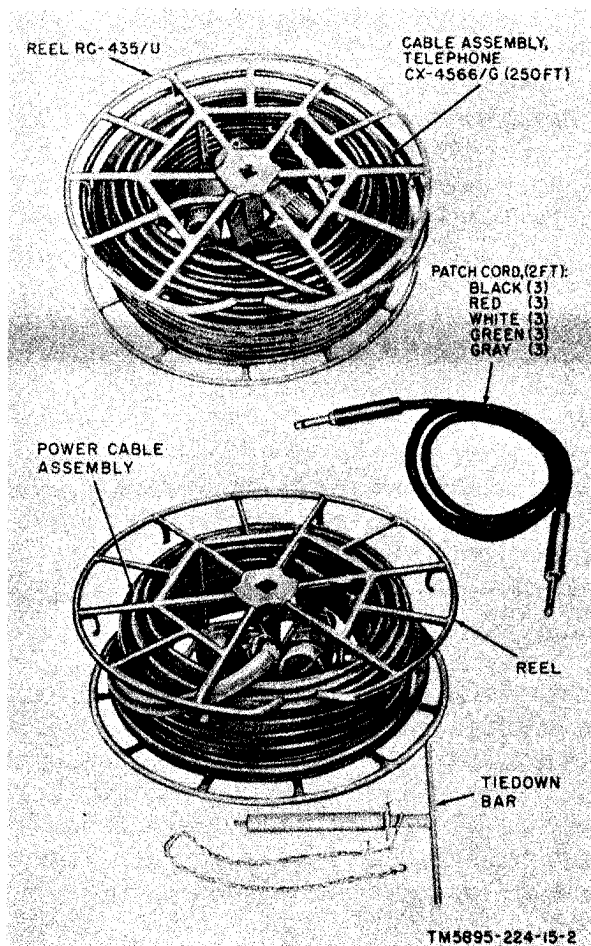

Figure 3. Shelter, Electrical Equipment, S-184/MSC-32, cable assemblies, reels, and patch cords.

folding slide panels (not shown) for weather protection and secured, with captive-screw-type fasteners.

- (a) The power and signal entrance box (fig. 8) contains receptacles and binding posts for connecting ac power and signal circuits to the shelter components. It also contains a duplex convenience outlet receptacle (115V AC) equipped with a spring-loaded watertight cover. Entrance to the rear of the power and signal entrance box is provided on the interior rear wall when the power entrance panel (fig. 14) is removed.
- (b) The binding post signal entrance

box (fig. 9) contains 21 pairs of binding posts for optional use in connecting signal circuits to the shelter components. Entrance to the rear of the binding post signal entrance box is provided on the interior rear wall of the shelter when the signal entrance panel (fig. 14) is removed.

- (3) *Power distribution panel* (fig. 10). The power distribution panel contains metering and control circuits for the ac distribution circuits.
- (4) *Power and signal wiring* (fig. 11, 12, and 13). Ac power is distributed through power ducts to the various ac power outlets. Signal wiring is distributed through signal ducts to the various components.

*b. Switchboard, Telephone, Manual SB-22(\*)/PT* (fig. 13). The SB-22(\*)/PT (TM 11-5805-262-12) is a local battery telephone switchboard used to switch 12 telephone or voice-frequency (vf) teletypewriter circuits.

*c. Telephone Set TA-312/PT* (fig. 24). The TA-312/PT's are used for local telephone communication. One TA-312/PT (less carrying case) is mounted on the curbside wall (fig. 11). Three TA-312/PT's are stored in a storage cabinet; when required for use, they are placed on the tabletop (fig. 12 and 13) adjacent to a PHONE jack.

*d. Terminal, Telegraph TH-5/TG* (fig. 13). The TH-5/TG's (TM 11-5805-246-10) are used to send and receive vf teletypewriter signals for the teletypewriters (*e* and *f* below).

*e. Teletypewriter TT-4(\*)/TG* (fig. 13). The TT-4(\*)/TG's (TM 11-5815-206-12) are used to send (keyboard) and receive (printed page) dc teletypewriter signals.

*f. Repeater-Transmitter, Teletypewriter TT-76(\*)/GGC* (fig. 13). The TT-76(\*)/GGC (TM 11-2225) is used to send (keyboard or transmitter distributor) and receive (tape) dc teletypewriter signals.

*g. Terminal Box TA-125/GT*. The TA-125/GT (TM 11-2138) is stored in a storage cabinet. It is a 24-pair terminal box used to interconnect field-wire circuits during patching, testing, and monitoring procedures.

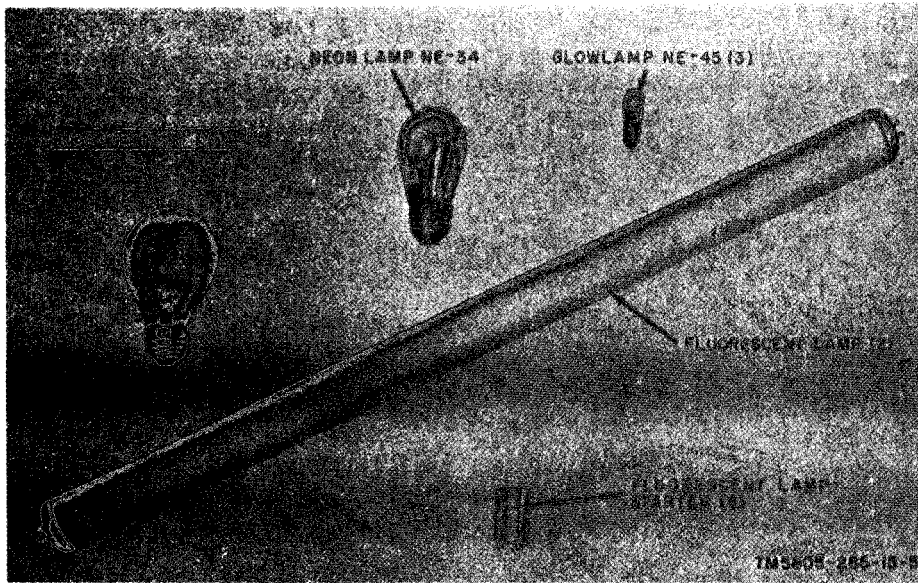

Figure 4. Shelter, Electrical Equipment, S-184/MSC-32, running spares.

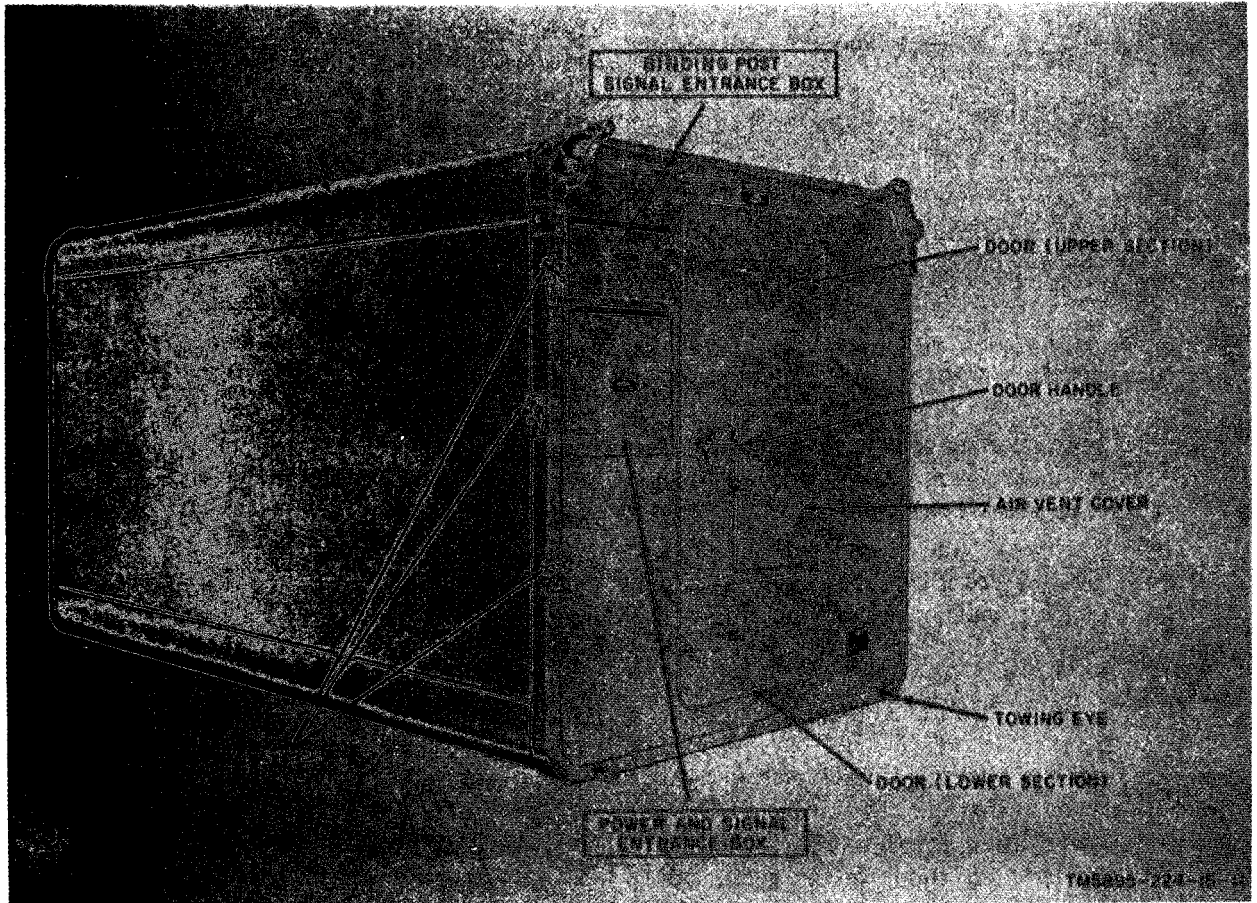

Figure 5. Operations Central AN/MSC-32.

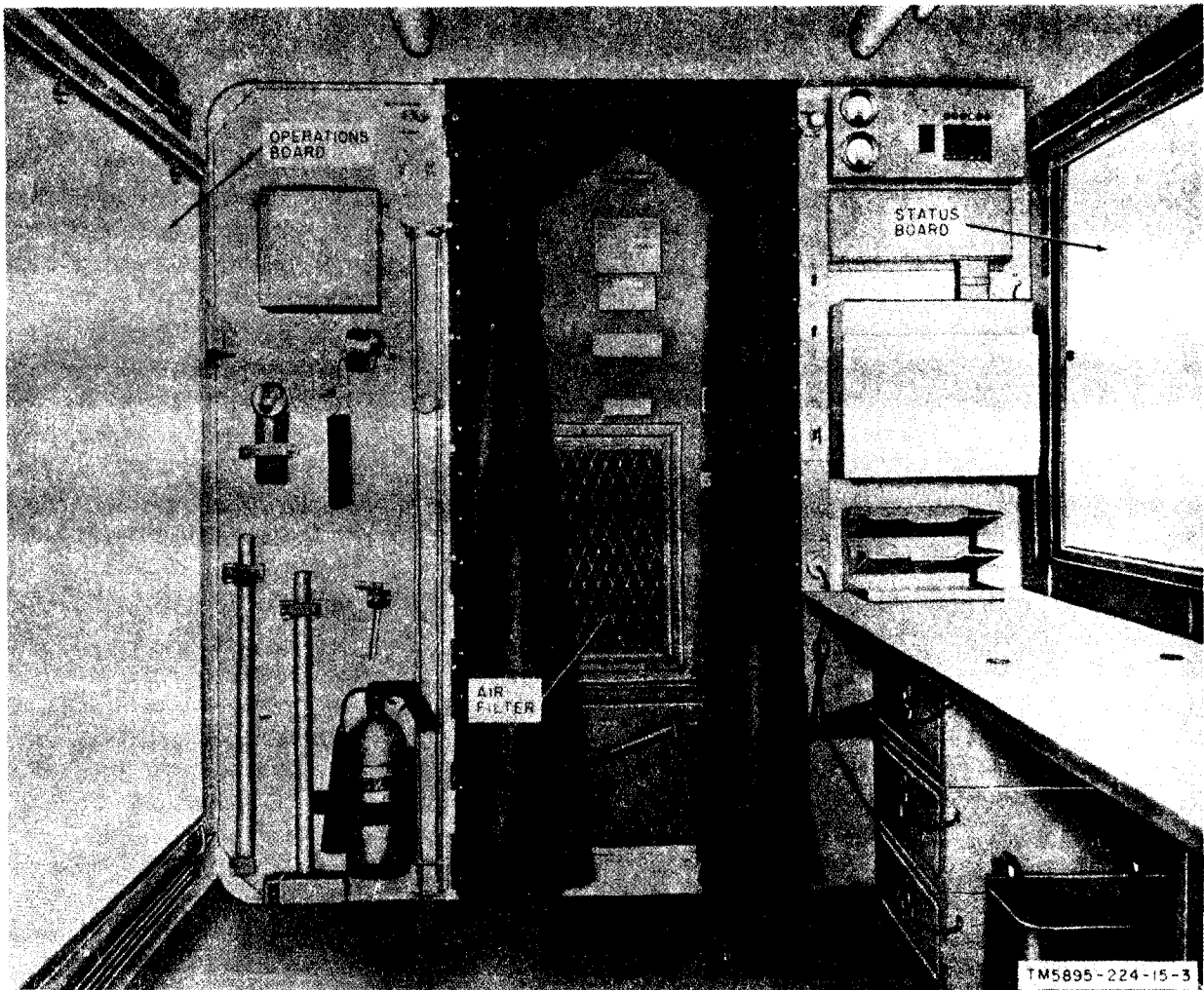

Figure 6. Operations Central AN/MSC-32, interior rear view.

## 8. Description of Shelter Components

a. *Electric Heaters* (fig. 17). The heaters are secured in their mounting bases on the floor of the shelter (fig. 12 and 13). Each heater contains a 1.5-kilowatt heating element and a fan for air circulation. Horizontal louvers on the front of each heater are adjustable to deflect the airstream. Operating controls are on the top of each heater.

b. *Intercommunication Station LS-147(\*)/FI* (fig. 18). The LS-147(\*)/FI provides two-way nonprivate communication in a system that consists of other LS-147(\*)/FI's or equivalent equipment.

c. *Exhaust Blowers*. Two exhaust blowers

(fig. 13) are equipped with removable covers (not shown) which muffle the sound when the exhaust blowers are operating. Exhaust vents to the outside of the shelter are provided.

d. *Distribution Box J-1077A/U*. The J-1077A/U (fig. 13) is a terminal box which can be used to connect field wires to a 26-pair cable connector.

e. *Clock*. An 8-day luminous-dial 24-hour clock is mounted on the front wall (fig. 13). A knob on the left-hand side is used for winding and setting the clock.

f. *Patch Panel* (fig. 13 and 19). The patch panel provides a means of rearranging the SB-22(\*)/PT and the TH-5/TG circuits.



Figure 7. Operations Central AN/MS-32, interior front view.

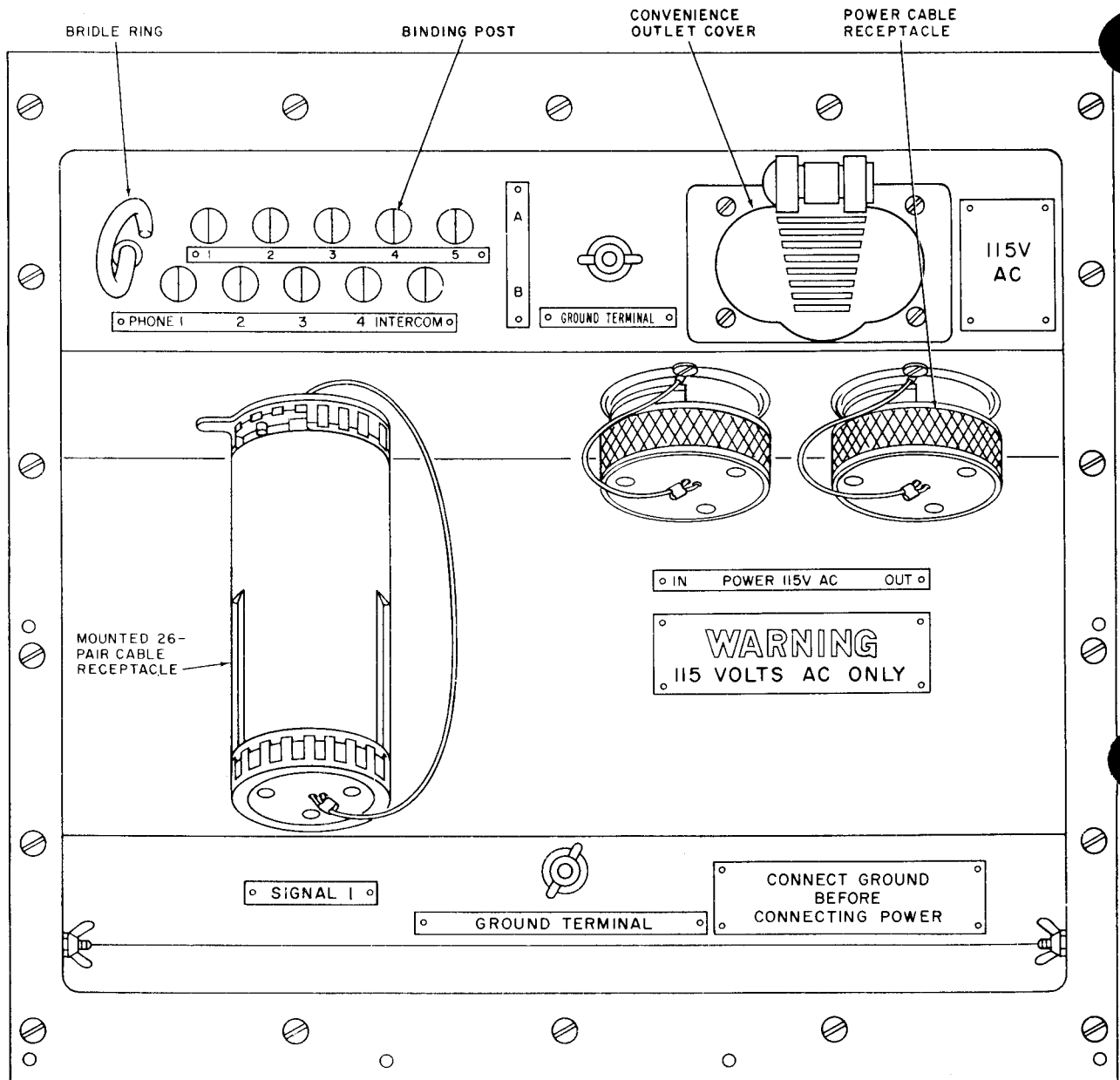

TM5895-223-15-12

Figure 8. Power and signal entrance box.

g. Teletypewriter Patch Panel (fig. 13 and 20). The teletypewriter patch panel provides a means of connecting the cords of the TT-4A(\*)/TG's and the TT-76(\*)/GGC to the teletypewriter circuits.

h. TH-5/TG Subdistribution Panel (fig. 12 and 21). The panel distributes and controls ac power to the TM-5/TG's.

i. Cords and Cables.

- (1) Power cable assembly and reel (fig. 3). The power cable assembly is wound on a reel, which is secured to the floor at the front of the shelter (fig. 7 and 15). It is a 100-foot, 3-conductor cable with a watertight power connector on each end.
- (2) Power cable stub (fig. 2). The power cable stub is a 15-foot, 3-conductor

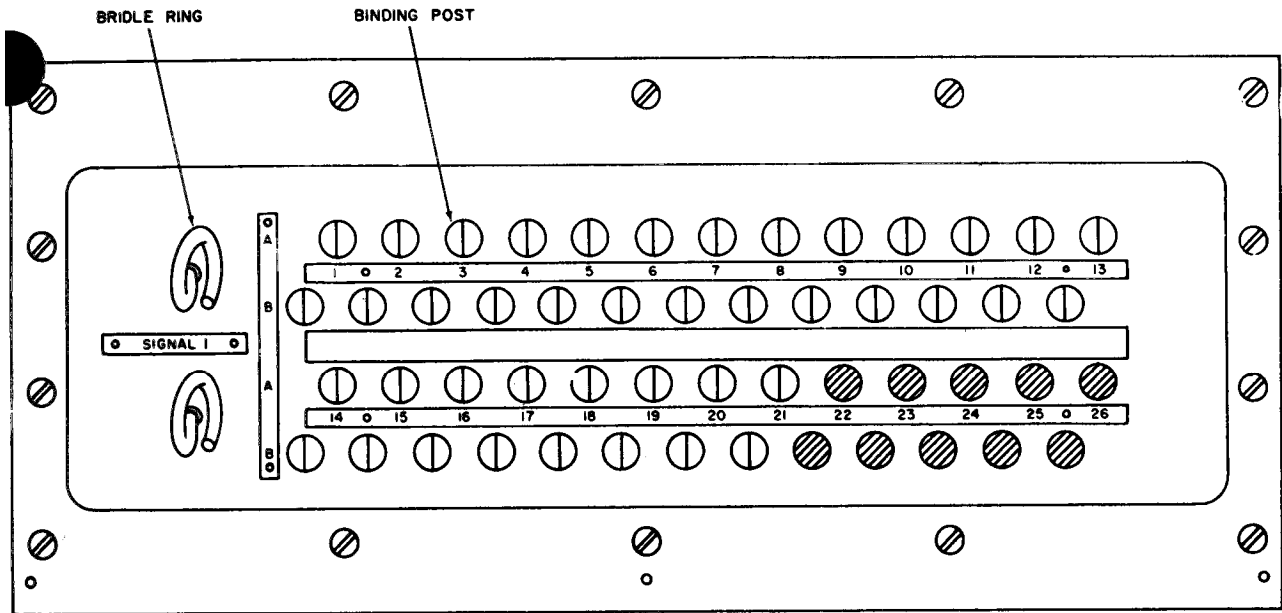

TM5895-224-15-15

Figure 9. Binding post signal entrance box.

- cable with a watertight power connector one end, and red, white, and black prepared leads on the other end.
- (3) *Cable Assembly, Telephone CX-4566/G and Reel RC-485/U* (fig. 3). The CX-4566/G is 250-feet long and is equipped with a 26-pair cable connector on each end.
  - (4) *Cable Assembly, Telephone CX-4760/U* (fig. 2). The CX-4760/U is a 26-pair cable stub that is 15 feet long and is equipped with a 26-pair cable connector on one end and prepared leads on the other end.
  - (5) *SB-22/PT cable stub* (fig. 23). The SB-22/PT cable stub is 3 feet long; and is equipped with a 26-pin connector on one end and prepared leads on the other end.
  - (6) *Patch cords* (fig. 3). The patch cords are two-conductor cords, equipped with telephone plugs at each end.
  - (7) *Telephone and teletypewriter connecting cords* (fig. 2). The telephone (4 feet and teletypewriter (6 feet) connecting cords are two-conductor cords equipped with telephone plugs on one end and prepared leads on the other end.



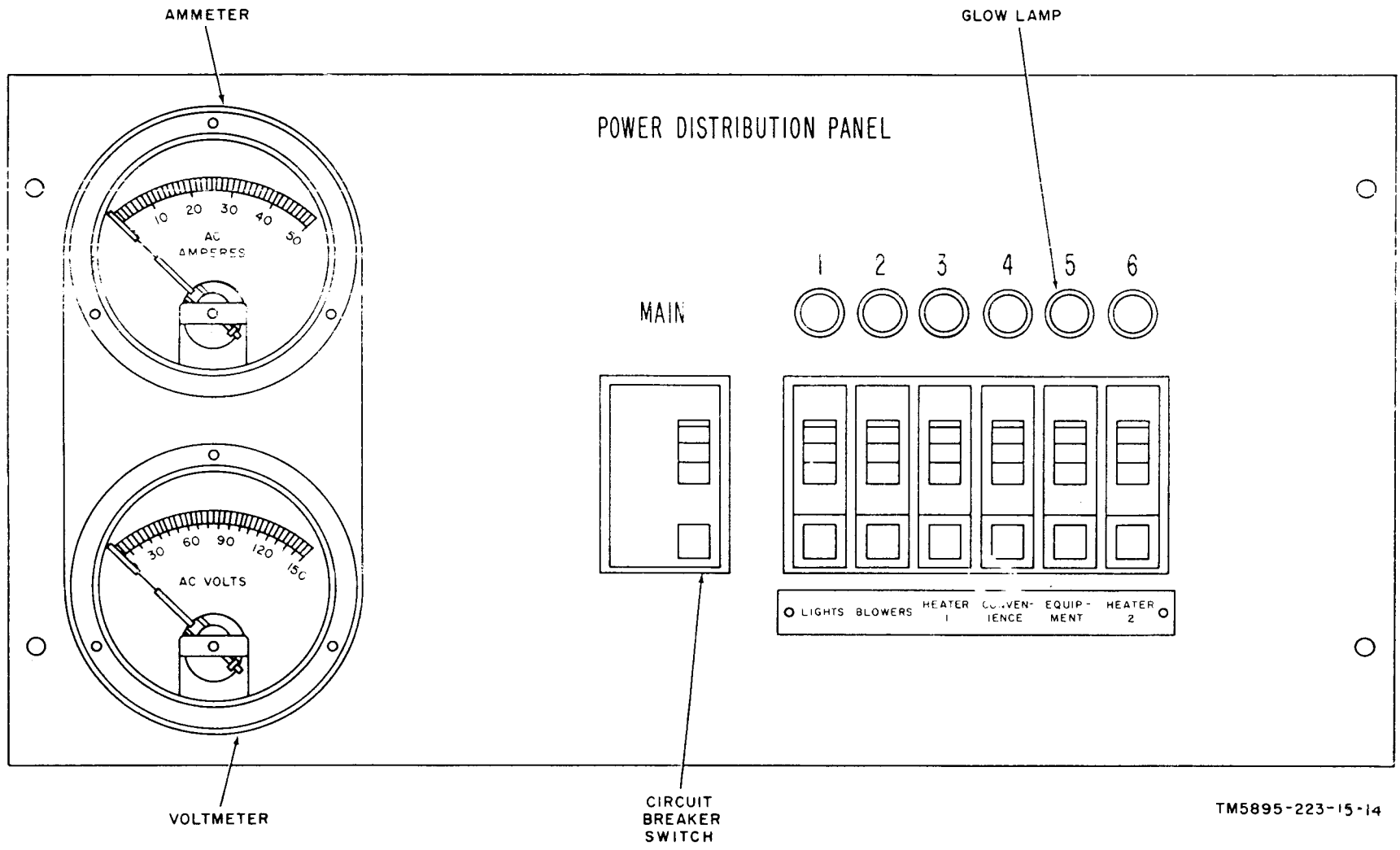

TM5895-223-15-14

Figure 10. Power distribution panel.

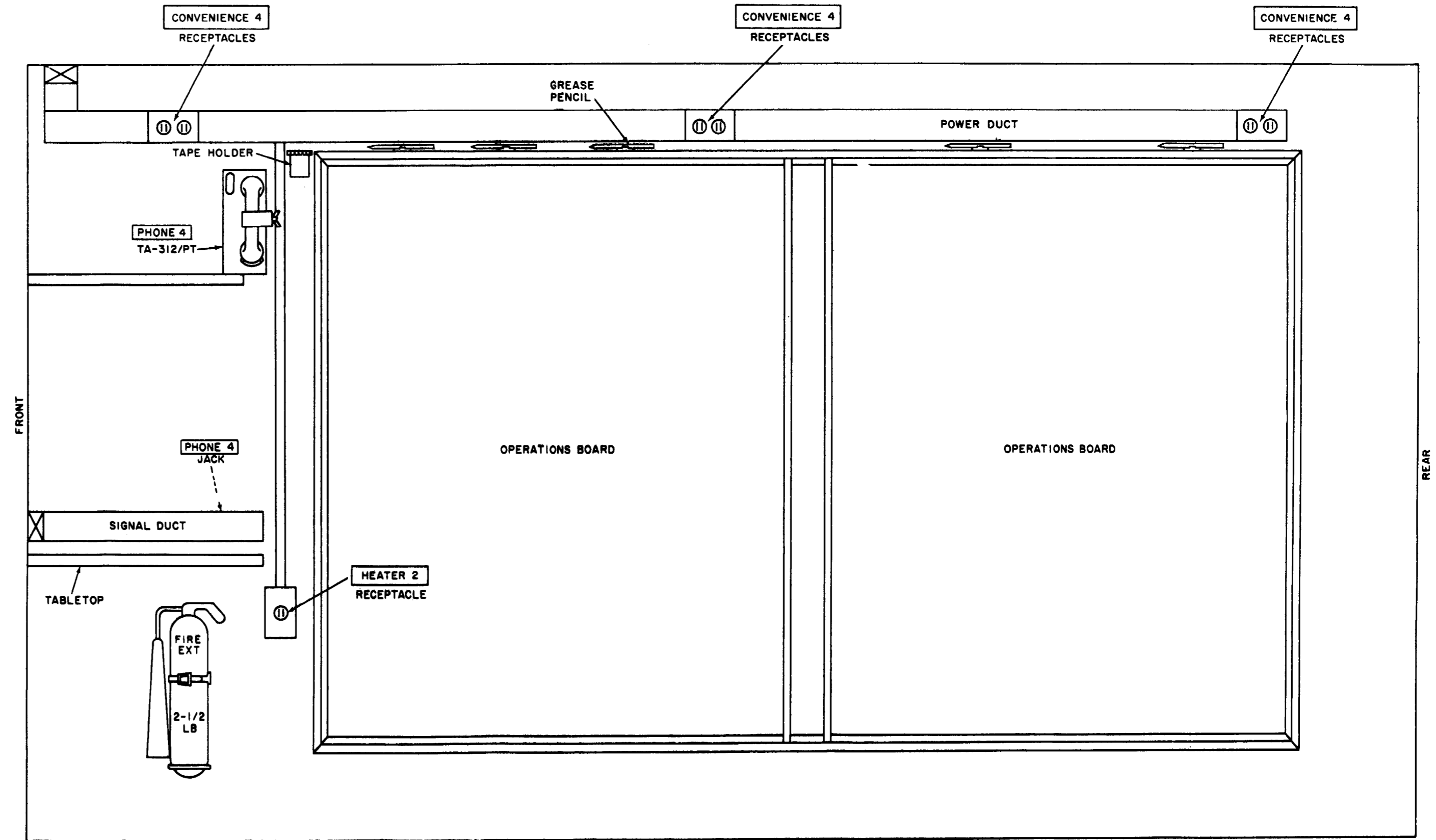
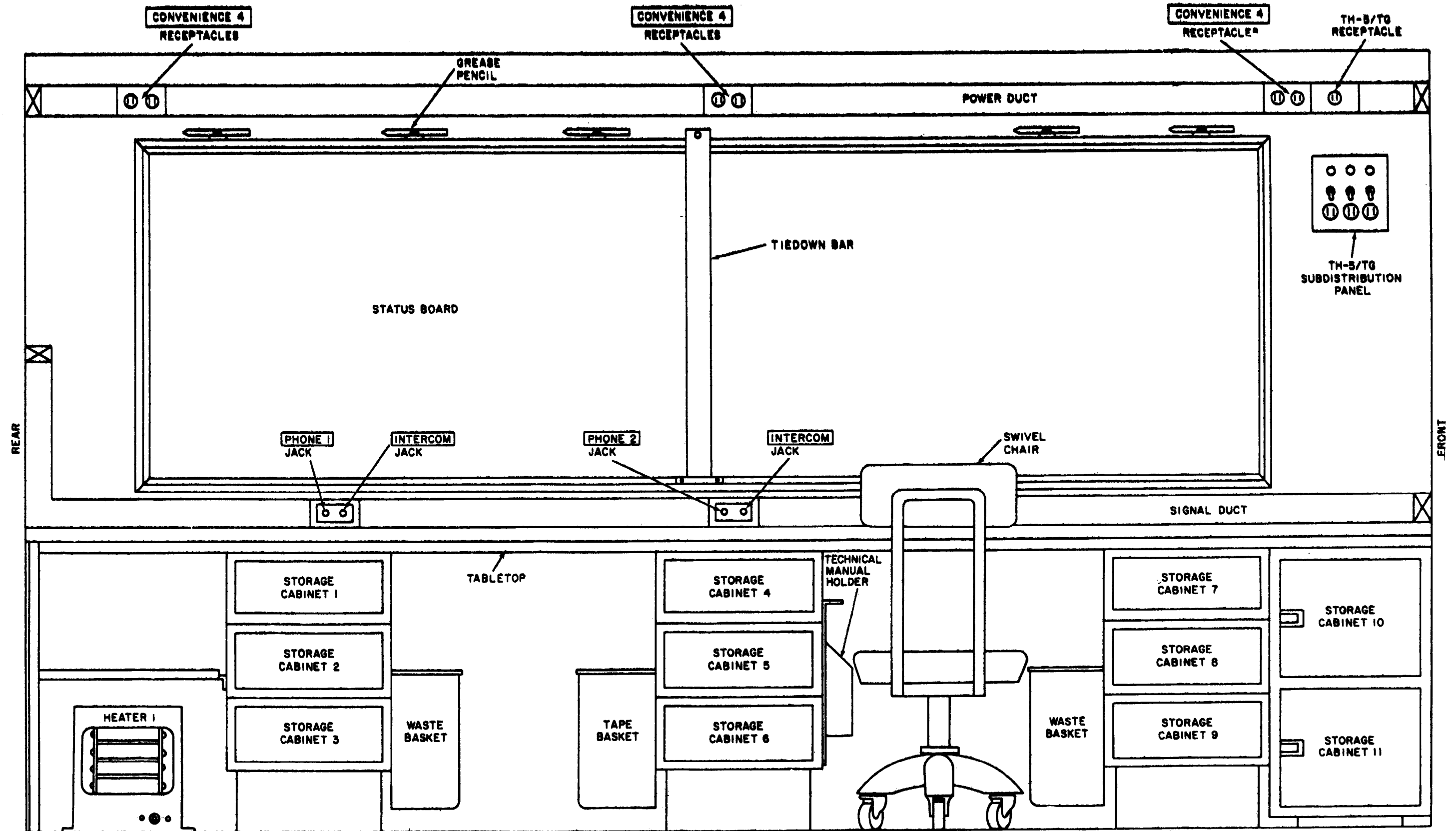

Figure 11. Operations Central AN/MBC-38, curbside wall, elevation drawing.



TM5895-224-15-6

Figure 18. Operations Control AN/MBC-22, roadside stall, elevation drawing.

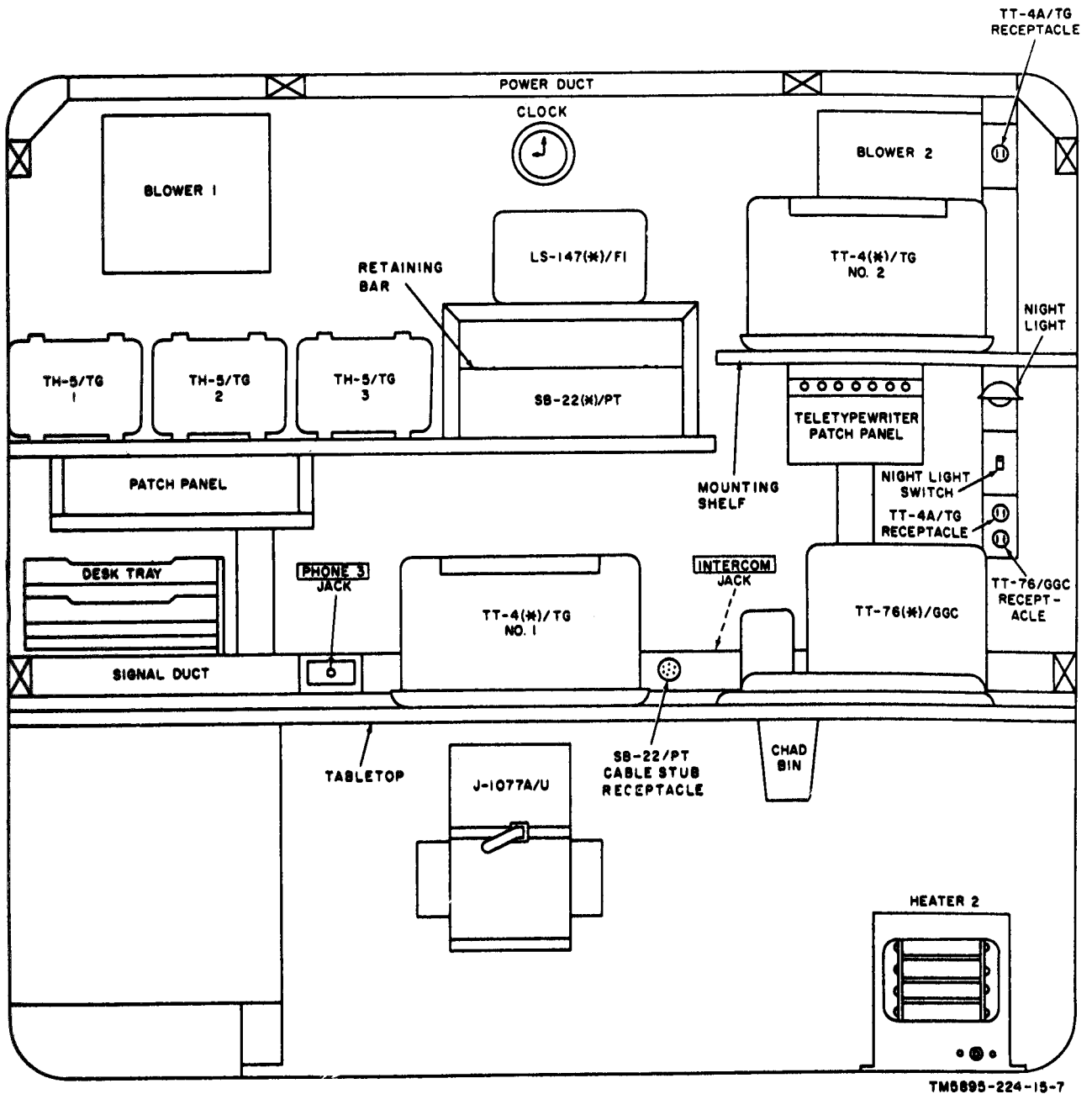
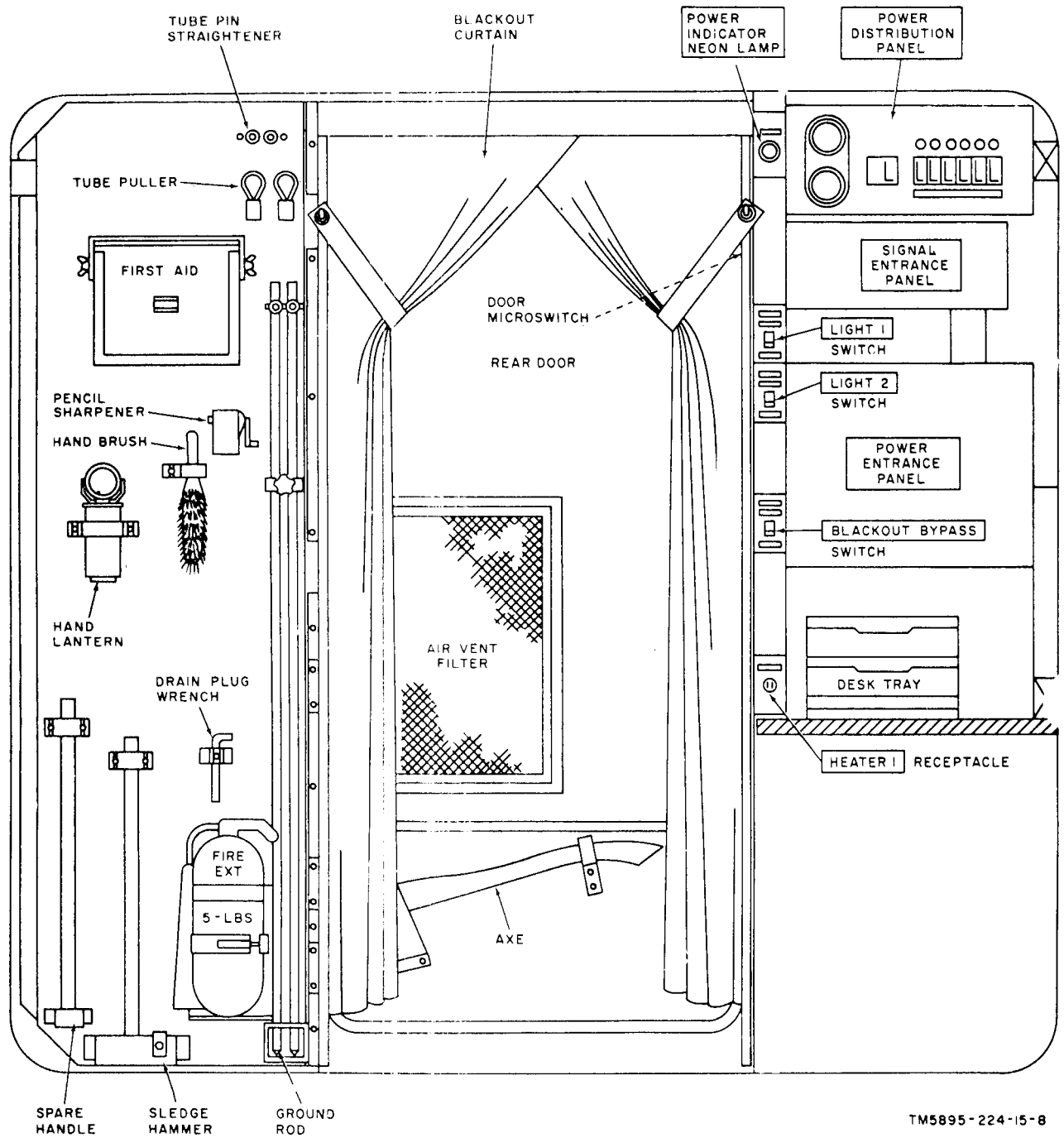
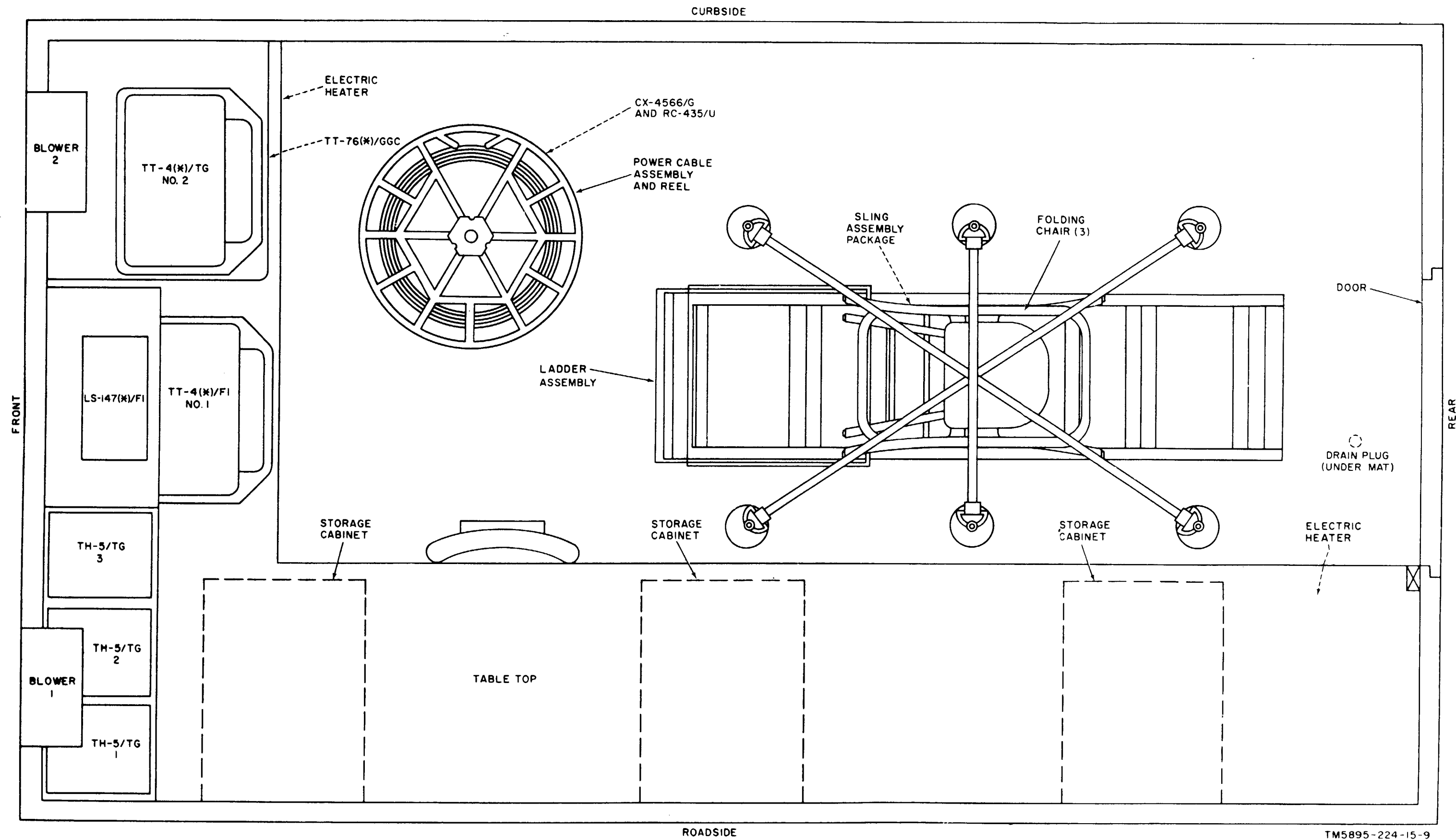

Figure 13. Operations Central AN/MS-32, front wall, elevation drawing.



TM5895-224-15-8

Figure 14. Operations Central AN/MS-32, rear wall, elevation drawing.



TM5895-224-15-9

Figure 15. Operations Central AN/MSC-32, floor plan.

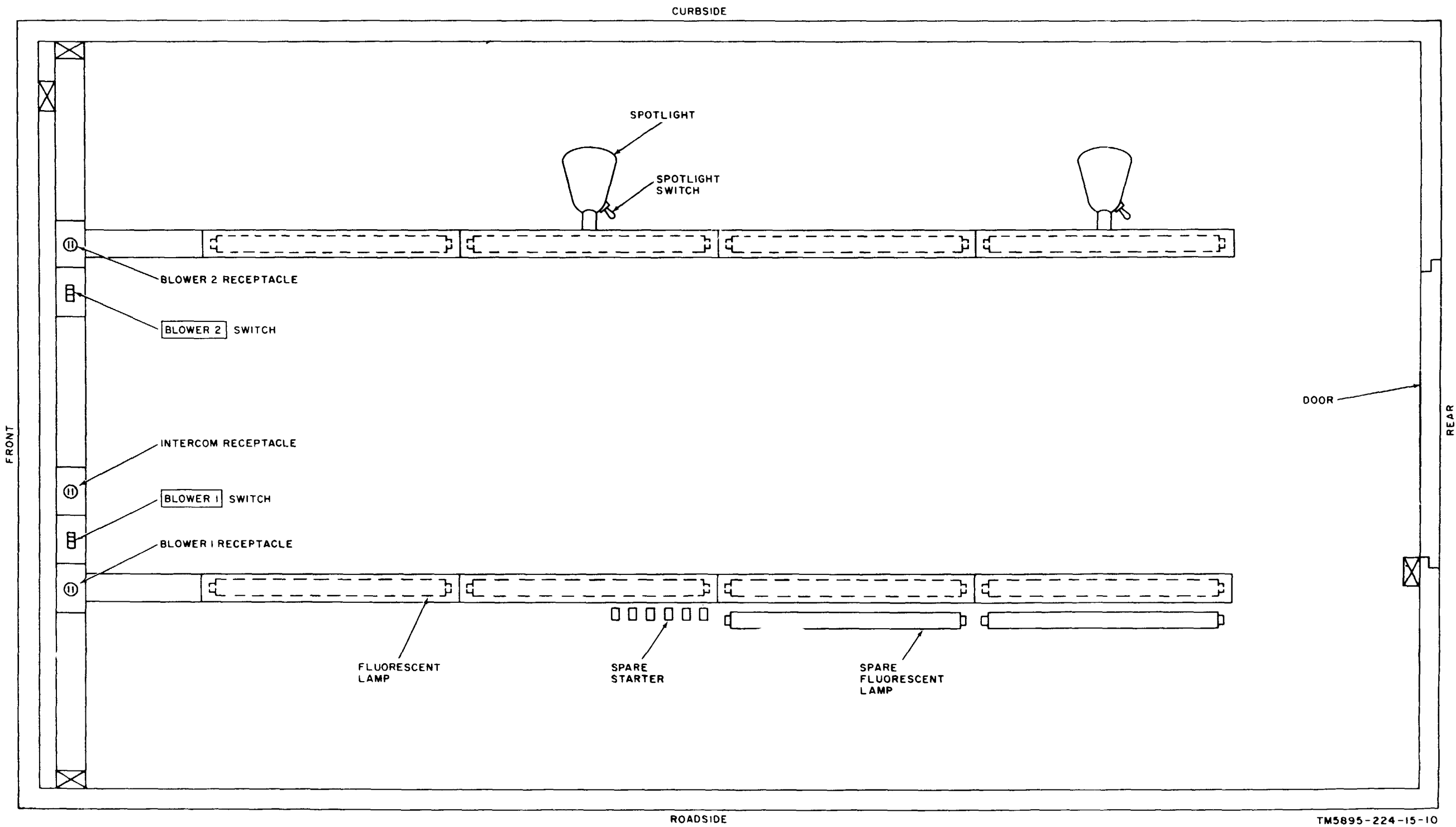

Figure 16. Operations Central AN/MS-32, ceiling plan.

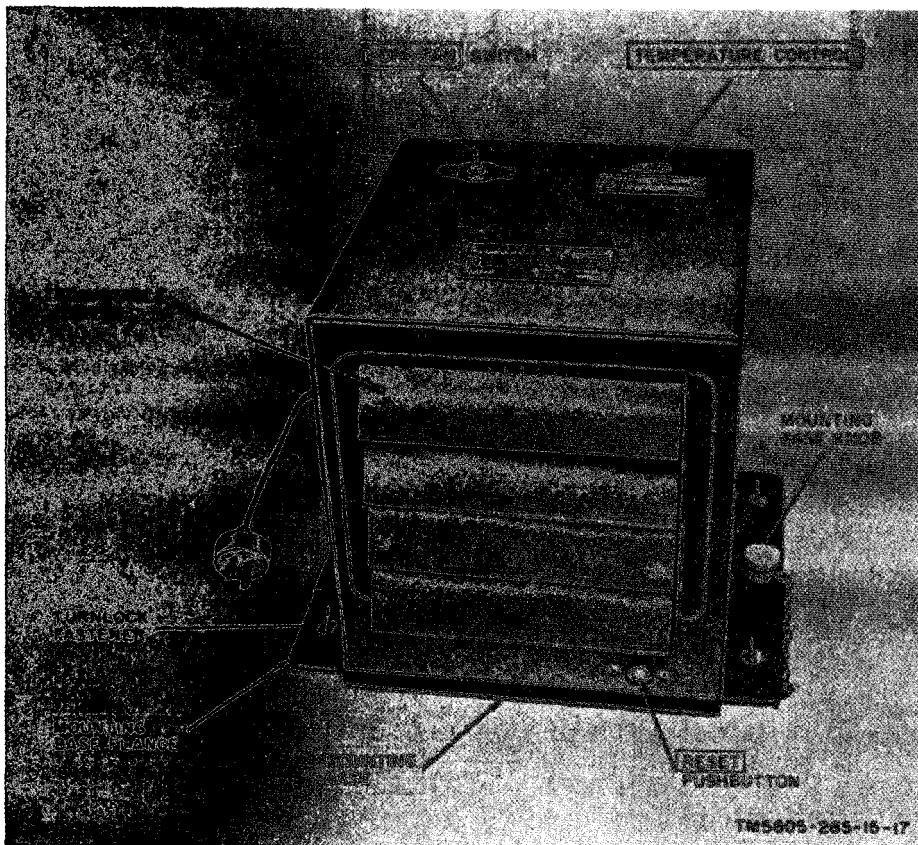

Figure 17. Electric heater.

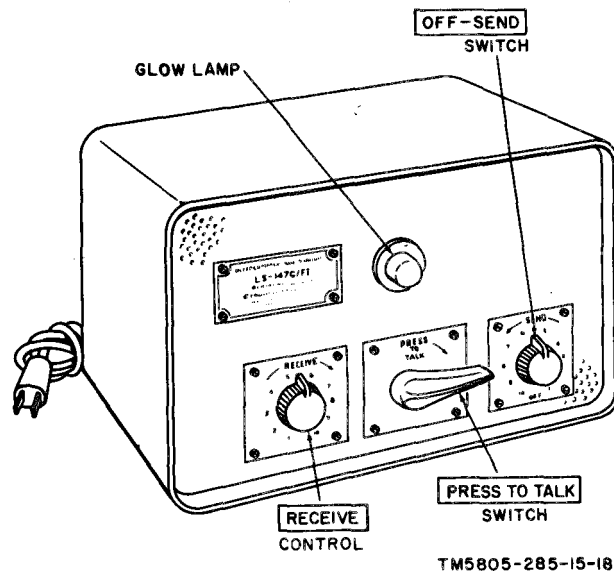

Figure 18. Intercommunication Station LS-147C/F1.



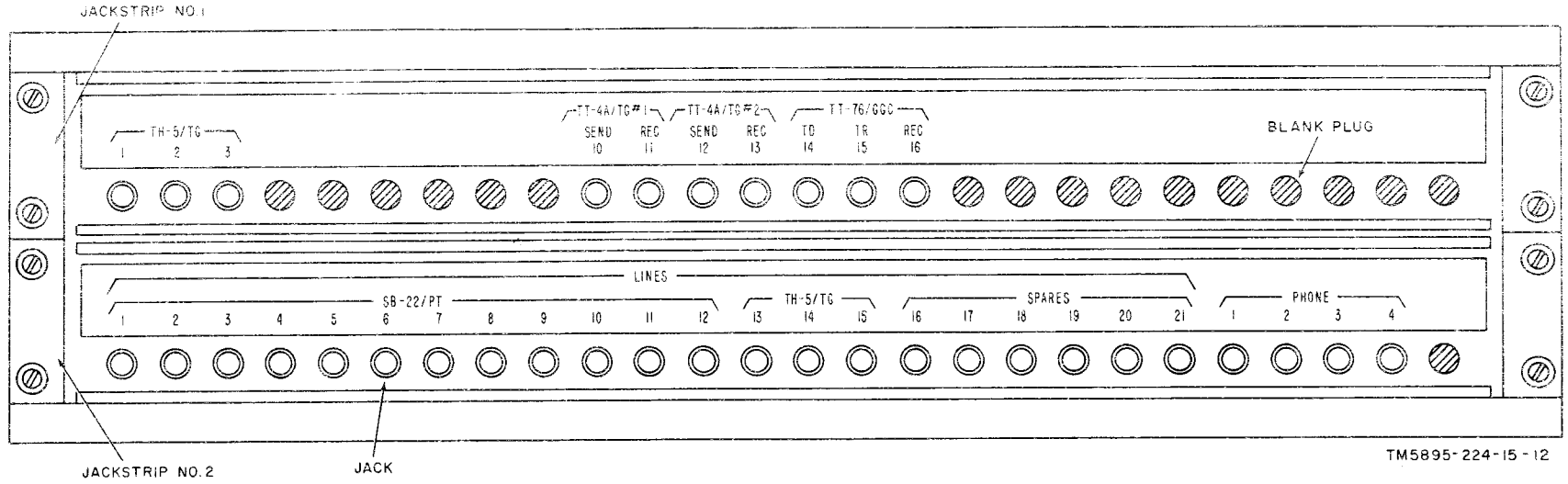
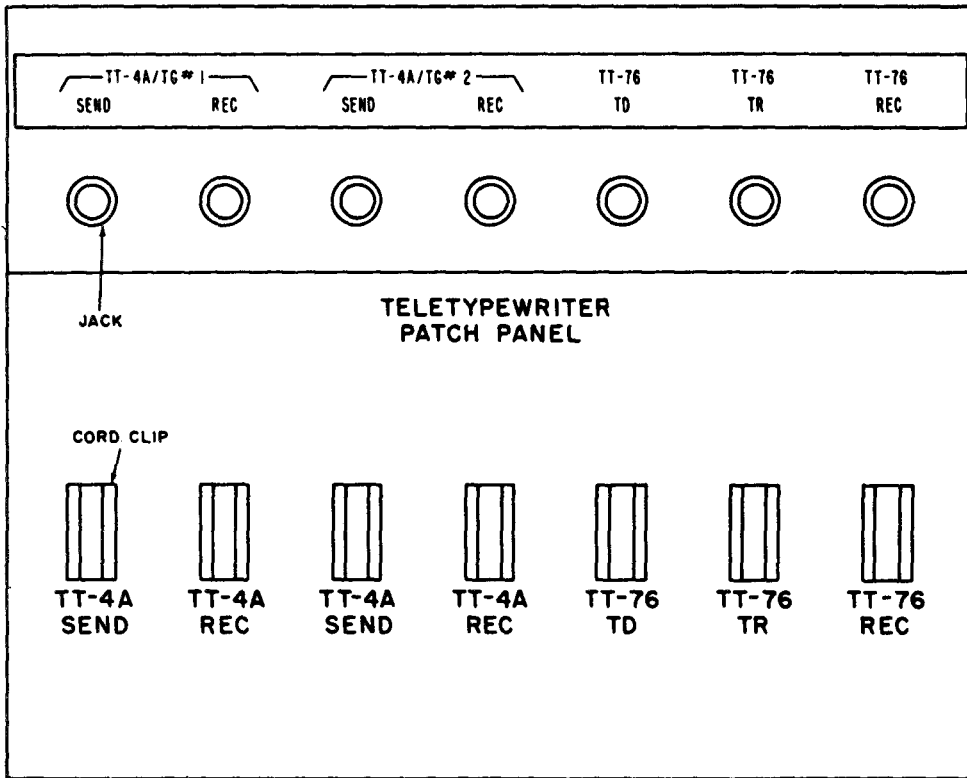
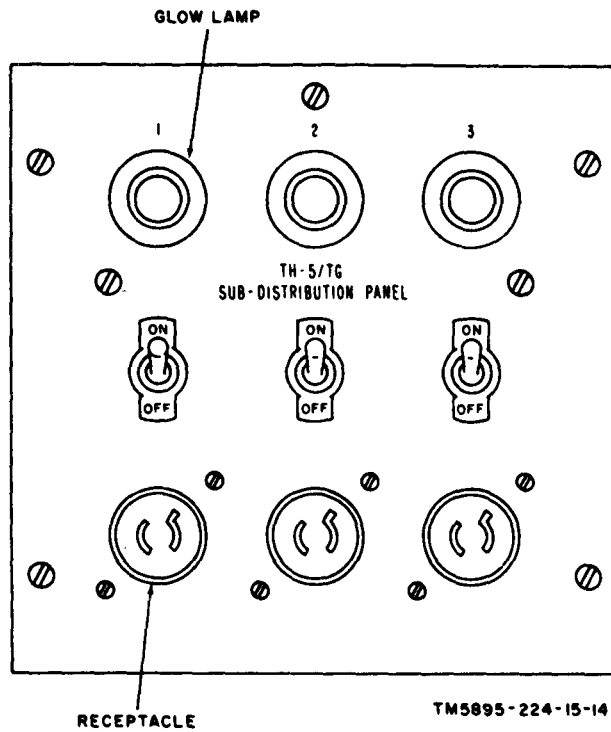

Figure 19. Patch panel.



TM5895-224-15-13

Figure 20. Teletypewriter patch panel.



TM5895-224-15-14

Figure 21. TH-5/TG subdistribution panel.

## CHAPTER 2

### INSTALLATION AND PREOPERATIONAL PROCEDURES

---

#### Section I. INSTALLATION, CONNECTION, AND TESTING OF INSTALLED EQUIPMENT

##### 9. General

a. When an AN/MS-32 is received, uncrate and check it ( para 10 ) ; then perform the tests given in paragraph 17. When an S-184/MS-32 is received, perform the procedures outlined in (1) through (4) below.

- (1) Uncrate and check the equipment (para 10).
- (2) Install and interconnect the following equipment:
  - (a) SB-22(\*)/PT (para 11).
  - (b) TA-312/PT (para 12).
  - (c) TH-5/TG's (para 13).
  - (d) TT-76(\*)/GGC (para 14).
  - (e) TT4 (\*)/TG's (para 15).
- (3) Store the TA-125/GT ( para 16a) and the J-1077A/U (para 16b); check the LS-147 ( \* ) /FI connections (para 16c).
- (4) Check the equipment (para 17).

b. The signal duct contains all the wiring required to connect the equipment to the external line circuits. All wiring is appropriately marked and prepared for connection. The signal schematic-wiring diagram (fig. 42) supplements the information given in the connection procedures. The power duct contains power receptacles appropriately marked for each piece of equipment that requires ac power.

c. A tool kit (para 5b and fig. 2) is used for equipment installation and connection.

Note. Ground (para 20) and connect the power (para 21) to the shelter before using the lights or the convenience receptacles.

##### 10. Uncrating and Checking

a. *Uncrating Shelter (fig. 22).*

- (1) Remove the panels of the crate by re-

moving the bolts. First remove the front and rear panels; then remove the top and side panels.

- (2) Remove the four lag screws that secure the base of the crate to the shelter.
- (3) Remove the sling assembly (fig. 26) from its package on the floor of the shelter (fig. 15).
- (4) Use a device capable of lifting 3,000 pounds to remove the shelter from the base of the crate. Attach the sling assembly to the lifting eyes on the top corners of the shelter (para: 19a) and raise the shelter off the base of the crate.
- (5) Remove the base of the crate and lower the shelter.
- (6) Remove the sling assembly from the shelter and the lifting device.

b. *Checking Shelter Contents.* Check the contents of the shelter against the packing list. If the packing list is not available, use the table of components ( para 5) to check the equipment that *probably* was packed.

##### II. Installation and Connection of SB-22(\*)/PT

a. Remove the front cover of the SB-22 ( \* ) /PT (TM 11-5805-262-12).

b. Remove headset-handset (H-81/U or H-144/U) from the front cover and store the cover.

c. Open the rear cover of the SB-22 ( \* ) /PT and install four Batteries BA-30 in the battery case.

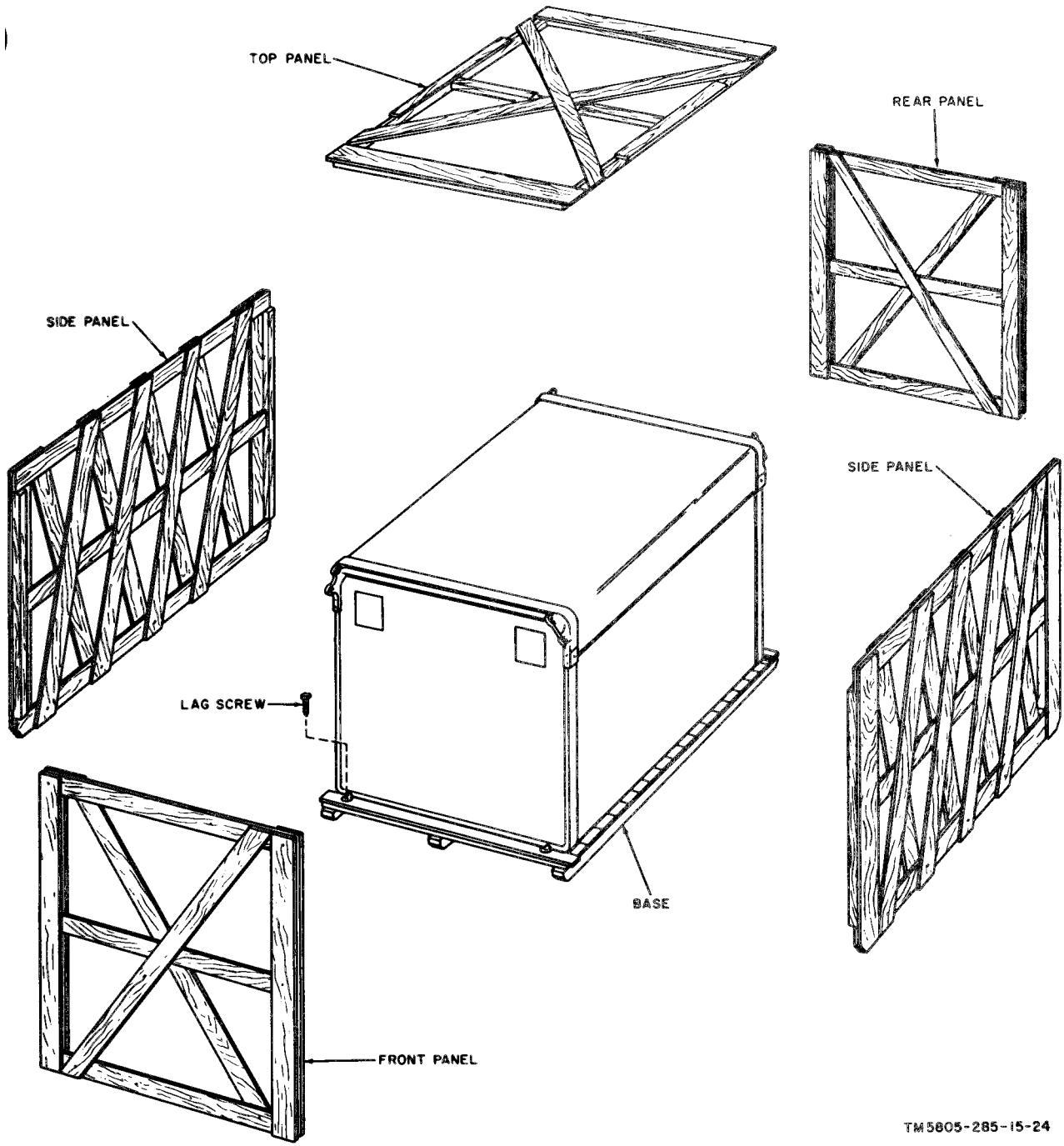

TM 5805-285-15-24

Figure 22. Shelter, Electrical Equipment S-184/MSC-32, typical crating diagram.

d. Remove the cable clamps that hold the SB-22/PT cable stub in place (fig. 23).

e. Disconnect the connector of the SB-22/PT cable stub from its receptacle in the signal duct (fig. 13) and pull the cable up through

the hole in the SB-22/PT mounting rack until the connector reaches the hole.

f. Place the SB-22(\*)/PT on the tabletop near the prepared leads of the cable stub and make the following connections.

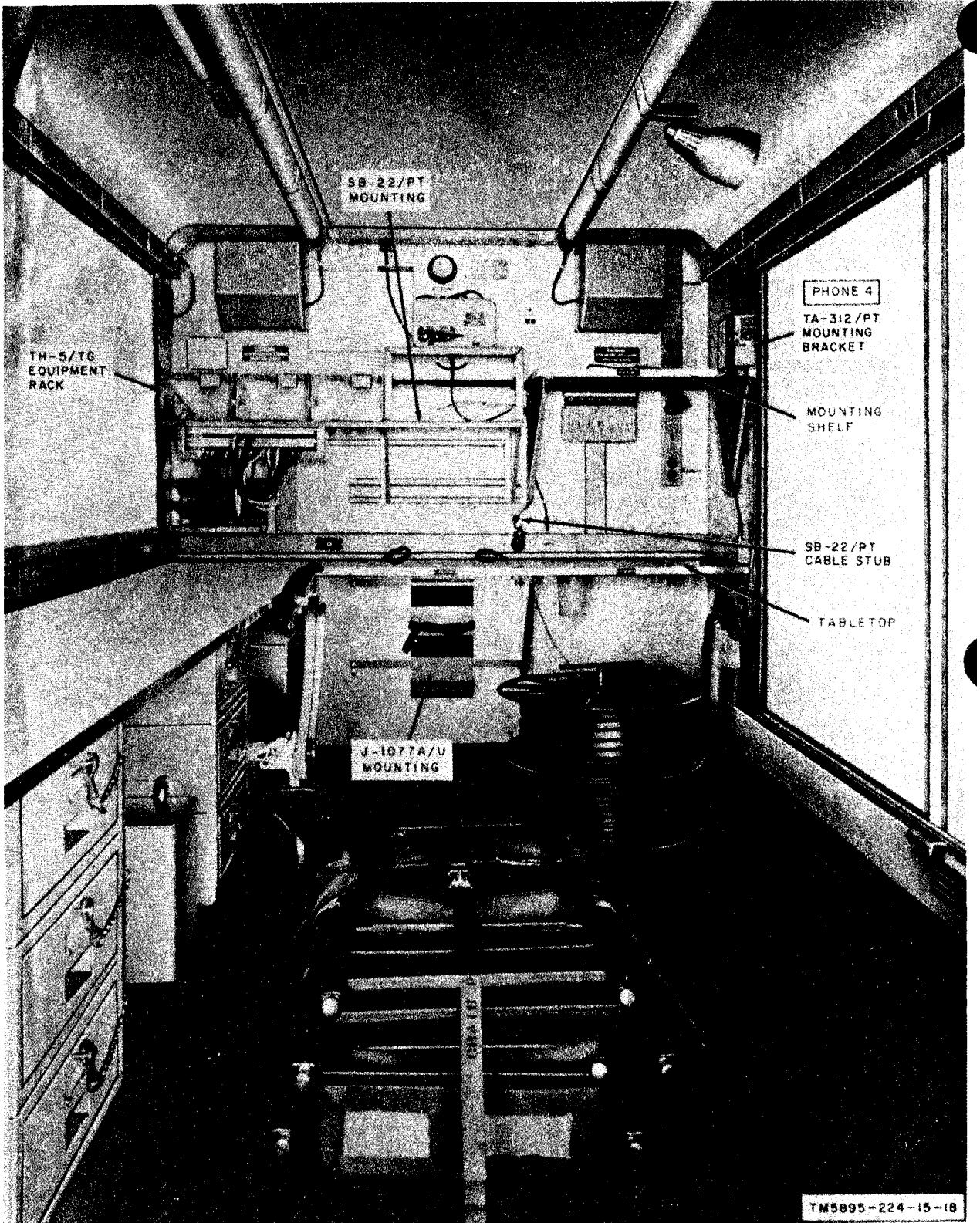

Figure 23. Shelter, Electrical Equipment S-184/MSC-32, equipment mounting facilities

- (1) Connect a wire to the GRD binding post on the rear of the SB-22(\*)/PT.
- (2) Connect the prepared leads from the SB-22/PT cable stub to the SB-22(\*)/PT binding posts according to the following chart:

Wire designation	SB-22/PT cable stub		SB-22(*)/PT Binding post pair
	Wire color	Wire color	
1	Wht-blu, wht-orn-blu		1
2	Wht-brn-blu, wht-gy-blu		2
3	Wht-grn, wht-orn-grn		3
4	Wht-grn-blk, wht-yel-grn		4
5	Wht-brn-grn, wht-gy-grn		5
6	Wht-blu-blk, wht-yel-blu		6
7	Wht-brn, wht-grn		7
8	Wht-blk, wht-orn		8
9	Wht-brn-gy, wht-brn-vio		9
10	Wht-yel, wht-blu-grn		10
11	Wht-red, wht-gy		11
12	Wht-blk-red, wht-orn-red		12

*g.* Remove the wingnuts that secure the retaining bar in the SB-22(\*)/PT mounting rack (fig. 13), and raise the retaining bar.

*h.* slide the SB-22(\*)/PT into the mounting rack; replace the retaining bar and secure it in place with the wingnuts.

*i.* Pull the SB-22/PT cable stub and connect the SB-22/PT cable stub connector to the receptacle in the signal duct (fig. 13). Replace the cable clamps to hold the SB-22/PT cable stub in place.

*j.* Connect the ground wire (*f*(1) above) to a screw in the signal duct.

*k.* Connect the handset-headset (*b* above) to the SB-22(\*)/PT and perform the preinstallation checks (TM 11-5805-262-12).

## 12. Installation and Connection of TA-312/PT

To install the TA-312/PT (designated PHONE 4) in its mounting bracket (fig. 11 and 23), follow the procedures in *a* below. When the TA-312/PT's are to be used at the status board (fig. 12) or in front of the shelter (fig. 13), position each TA-312/PT near the desired PHONE jack and perform the procedures in *b* below.

### *a.* Installation.

- (1) Loosen the wingnut on the side of

the mounting bracket.

- (2) Rotate the clamping arm upward to gain access to the flathead screw on the side of the mounting. Tighten the wingnut.
- (3) Use a screwdriver to remove the flathead screw that secures the holding plate (inside the mounting bracket).
- (4) Remove the TA-312/PT from its carrying case; store the case.
- (5) Insert the holding plate into the buzzer recess in the side of the TA-312/PT.
- (6) Place the TA-312PT in the mounting bracket and replace the flathead screw.
- (7) Install two Batteries BA-30 in the TA-312/PT and operate the LB-CB-CBS switch to LB.

### *b.* Connection.

- (1) Connect the prepared leads of a telephone connecting cord (fig. 2) to the LINE binding posts of the TA-312/PT.
- (2) Connect PHONE 4 TA-312/PT tele-

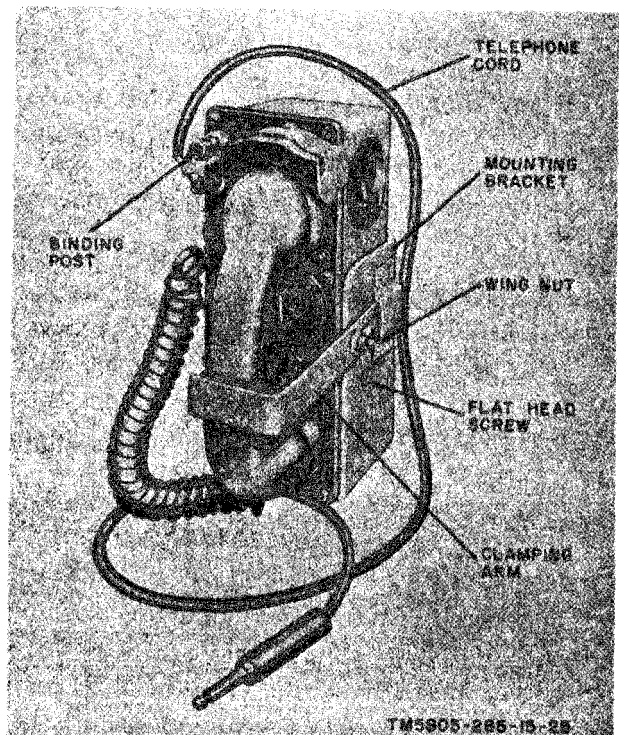

Figure 24. Telephone Set TA-312/PT, installed for transit.

phone connecting cord plug to PHONE 4 jack (fig. 11).

- (3) Connect the other TA-312/PT's telephone connecting cord plug to PHONE 1, 2, or 3 jack (fig. 12 and 13) as desired.

### 13. Installation and Connection of

#### TH-5/TG

(fig. 13 and 23)

##### a. Installation.

- (1) Remove the TH-5/TG front panel and chassis assembly from its case (TM 11-5805-246-10).
- (2) Remove the spare fuses from the cover assembly and store the fuses in a storage cabinet.
- (3) Turn the TH-5/TG chassis over and check to see that the bare strap is connected between terminals D2 and F2. Connect a strap between the terminals if none is provided.
- (4) Install each TH-5/TG in the TG-5/TG equipment rack by lifting the designation plate on the rack; slide the TH-5/TG into the rack and tighten the captive screws to secure the chassis in position.

##### b. Connection.

- (1) Connect the appropriate wire pair to the TH-5/TG 2W binding posts according to the following chart:

Designation	Sig wire Color	TI -5/TG	
		No.	Binding post
106	Wht-yel-grn	1	6
104	Wht-grn-blk	1	4
206	Wht-gy-grn	2	6
204	Wht-brn-grn	2	4
306	Wht-yel-blk	3	6
304	Wht-blu-b'k	3	4

- (2) Connect the TH-5/TG power cord connector into the associated receptacle on the TH-5/TG subdistribution panel (fig. 12 and 21).

### 14. Installation and Connection of

#### TT-76(\*)/GGC

(fig. 13)

a. Remove the wooden shipping base and the dust cover from the TT-76(\*)/GGC (TM 11-2225).

b. Place the TT-76(\*)/GGC in position on the table top. Align the holes in the TT-76(\*)/GGC base with the holes in the tabletop. Secure the TT-76(\*)/GGC in place with the nuts and bolts provided; attach the nuts at the underside of the tabletop.

c. Perform the appropriate preinstallation services, and preparation for starting procedures (TM 11-2225).

*Note.* Use the TT-76/GGC receptacle and the adjacent ground for power and ground connections (TM 11-2225).

d. Replace the dust cover on the TT-76(\*)/GGC and fasten the web strap across the top of the dust cover.

e. Insert the TT-76(\*)/GGC gray, black, and red teletypewriter connecting cord plugs into the TT-76 TD, TT-76 TR, and TT-76 REC jacks, respectively, on the teletypewriter patch panel (fig. 13 and 20). Set the cords into the associated cord clip.

### 15. Installation and Connection of

#### TT-4(\*)/TG's

(fig. 13)

a. Perform the appropriate service procedures upon receipt of equipment (TM 11-5815-206-12).

b. Remove the wingnuts from the underside of the TT-4(\*)/TG tabletop (TT-4(\*)/TG No. 1) or mounting shelf (TT-4(\*)/TG No. 2) and remove the retaining bars.

c. Position the TT-4(\*)/TG on the tabletop or mounting shelf. Place the retaining bars in the packboard lashing hooks on the TT-4(\*)/TG and through the holes in the tabletop or mounting shelf.

d. Replace and tighten the wingnuts.

e. Perform the appropriate preliminary installation and final installation procedures (TM 11-5815-206-12).

*Note.* Use the appropriate TT-4A/TG receptacle and adjacent ground connections (TM 11-5815-206-12).

t. Use the teletypewriter connecting cords (fig. 2) and make the connections at the TT-

(\*)/TG for full-duplex vf operation (TM 11-5816-206-12).

g. Insert the TT-4(\*)/TG black, and red teletypewriter connecting cord plugs into the TT-4A/TG (#1 or #2, as applicable) SEND and REC jacks, respectively, on the teletypewriter patch panel (fig. 13 and 20). Set the cords into the associated cord clip.

## 16. Installation of TA-125/GT, J-1077A/U, and Checking LS-147(\*)/FI Connections

a. *Installation of TA-125/GT.* Place the TA-125/GT in its mounting bracket in storage cabinet No. 12 and secure it in place with the straps provided.

b. *Installation of J-1077A/U.* Place the J-1077A/U in its mounting bracket (fig. 13) and secure it with the straps provided.

c. *Checking LS-147(\*)/FI Connections.* Check to see that the telephone connecting cord (fig. 2) is connected to the terminals in the rear of the LS-147(\*)/FI and that the connecting cord plug is inserted into the INTERCOM jack in the signal duct (fig. 13). Check to see that the LS-147(\*)/FI power cord connector is inserted into the INTERCOM receptacle.

## 17. Testing Equipment After Installation

### a. Preliminary Procedure.

(1) Ground the shelter (para 20) and make the power connections (para 21) before using the lights and convenience receptacles. For test purposes, any satisfactory ground may be used in place of the ground rods indicated.

(2) Energize the ac circuits (para 26).

**Notes. Refer to paragraph 25 for information covering the S-184/MSC-82 controls and instruments.**

(3) Connect the CX-4760/U connector to the 26-pair cable receptacle in the power and signal entrance box (para 23b).

(4) Remove the J-1077A/U from its mounting (fig. 13) and place it close to the prepared leads of the CX-4760/U.

(5) Refer to figure 39 for color code of wires identified with each cable pair in the CX-4760/U. Connect the prepared leads of the CX-4760/U to the J-1077A/U binding posts, starting with binding posts pair No. 1 for CX-4760/U pair 1. For example, connect CX-4760/U pair 1 (wht-blu (A) and wht-orn-blu (B)) to binding post pair No. 1 on the J-1077A/U; connect CX-4760/U pair 2 (wht-brn-blu (A) and wht-gy-blu (B)) to binding post pair No. 2 on the J-1077A/U, etc.

### b. SB-22(\*)/PT Circuits.

(1) Remove a TA-312/PT from the storage cabinet.

(2) Use field wire and connect the TA-312/PT to binding posts pair No. 1 at the J-1077A/U and perform the SB-22 (\*)/PT talking and ringing tests (TM 11-5805-262-12).

(3) Patch the LINES SB-22/PT jack No. 1 at the patch panel (fig. 19) to PHONE 4 jack. Perform the talking and ringing tests between the PHONE 4 TA-312/PT (fig. 11) and the TA-312/PT at the J-1077A/U ((2) above).

(4) Remove the connections to binding posts pair No. 1 at the J-1077A/U and connect the TA-312/PT to binding posts pairs No. 2 through 12, in turn. For each SB-22(\*)/PT line, perform the talking and ringing tests ((2) and (3) above).

### c. PHONE 1 Through PHONE 4 Circuits.

(1) Remove a TA-312/PT from the storage cabinet. Connect the prepared leads of a telephone connecting cord (fig. 2) to the LINE binding posts of the TA-312/PT.

(2) Connect the TA-312/PT (b(2) above) to binding posts pairs No. 22 through 24, at the J-1077A/U in turn. Connect the TA-312/PT ((1) above), in turn, to PHONE 1 through PHONE 3 jacks at the signal duct (fig. 12 and 13). Perform



the signaling and ringing tests between the TA-312/PT's.

- (3) Connect the TA-312/PT (b(2) above) to binding posts pair No. 25 at the J-1077A/U and perform the signaling and ringing tests between the TA-312/PT and the PHONE 4 TA-312/PT (mounted) (fig. 11).
- (4) Disconnect and store the TA-312/PT's used at the J-1077A/U and the PHONE 3 jack.

*d. TT-4(\*)/TG and TT-76(\*)/GGC Circuits.*

(1) *TT-4(\*)/TG No. 1.*

- (a) Patch LINES SPARES No. 16 jack to TT-4A/TG No. 1 SEND No. 10 jack at the patch panel; patch LINES SPARES No. 17 jack to TT-4A/TG No. 1 REC No. 11 jack at the patch panel.
- (b) Use field wire and connect, binding posts pair No. 16 to No. 17 at the J-1077A/U.
- (c) Operate TT-4(\*)/TG No. 1 for full-duplex operation (TM 11-5815-206-12). Clear copy should be received on the page printer.
- (d) Remove the patch cords ((a) above) and the strap ((b) above).

(2) *TT-4(\*)/TG No. 2.*

- (a) Patch LINES SPARES No. 18 jack to TT-4A/TG #2 SEND No. 12 jack at the patch panel; patch LINES SPARES No. 19 jack to TT-4A/TG #2 REC No. 13 jack at the patch panel.
- (b) Use field wire and connect binding posts pair No. 18 to No. 19 at the J-1077A/U.
- (c) Operate TT-4(\*)/TG NO. 2 for full-duplex operation (TM 11-5815-206-12). (Clear copy should be received on the page printer.
- (d) Remove the patch cords ((a) above) and the strap ((b) above).

(3) *TT-76(\*)GGC.*

- (a) Patch LINES SPARES No. 20

jack to TT-76/GGC TO No. 1 jack at the patch panel; patch LINES SPARES NO. 21 jack to TT-76/GGC REC No. 16 jack at the patch panel.

- (b) Use field wire and connect binding posts pair No. 20 to No. 21 at the J-1077A/U.
- (c) Operate the TT-76(\*)/GGC transmitter distributor (TM 11-2225). Clear copy should be received on the tape.
- (d) Patch LINES SPARES No. 20 jack to TT-76/GGC TR No. 15 jack at the patch panel.
- (e) Operate the TT-76(\*)/GGC keyboard (TM 11-2225). Clear copy should be received on the tape.
- (f) Remove the patch cords ((a) and (d) above) and the strap ((b) above).

*e. TH-5/TG Circuits.*

- (1) Patch the TT-4A/TG #1 SEND No. 10 and REC No. 11 jacks at the patch panel to TG-5/TG No. SEND and REC jacks, respectively.
- (2) Patch the TT-4A/TG #2 SEND No. 12 and REC No. 13 jacks at the patch panel to TG-5/TG No. 2 SEND and REC jacks, respectively.
- (3) Use field wire and connect binding posts pair No. 13 to No. 14 at the J-1077A/U.
- (4) Operate TH-5/TG No. 1 and No. 2 (para 27e).
- (5) Operate TT-4(\*)/TG No. 1 and No. 2, in turn (TM 11-5815-206-12). Clear copy should be received on the page printers.
- (6) Insert one end of a patch cord, in turn, into LINES TH-5/TG No. 13 and No. 14 jacks and TH-5/TG No. 1 and No. 2 jacks at patch panel, while operating TT-4(\*)/TG No. 1 ((4) above). Clear copy should be received on TT-4(\*)/TG No. 1 and no copy should be received on TT-4(\*)/TG No. 2. Remove the patch cord.

- (7) Patch LINES TH-5/TG No. 13 jack to TH-5/TG No. 1 and patch LINES TH-5/TG No. 14 to TH-5/TG No. 2 jack, in turn, at the patch panel while operating the TT-4(\*)/TG No. 1. Clear copy should be received on TT-4(\*)/TG No. 1 and No. 2. Remove the patch cord.
  - (8) Remove the patch cord used in (2) above and patch the TT-4A/TG #2 SEND No. 12 and REC No. 13 jacks at the jack panel to TH-5/TG No. 3 SEND and REC jacks, respectively.
  - (9) Remove the field wire connection to binding posts pair No. 14 at the J-1077A/U and connect the wire to pair No. 15.
  - (10) Operate TH-5/TG No. 3 (para 27e).
  - (11) Operate TT-4(\*)/TG No. 1 and No. 2, in turn (TM 11-5815-206-12).
- (12) Insert one end of a patch cord, in turn, into LINES TH-5/TG No. 15 and TH-5/TG No. 3 jacks at the patch panel. Clear copy should be received on TT-4(\*)/TG No. 1 and no copy should be received on TT-4(\*)/TG No. 2. Remove the patch cord.
  - (13) Patch LINES TH-5/TG No. 15 jack to TH-5/TG No. 3 jack at the patch panel.
  - (14) Operate TT-4(\*)/TG No. 1. Clear copy should be received at TT-4(\*)/TG No. 1 and No. 3 page printers.
  - (15) Remove the connections at the J-1077A/U.
  - (16) Remove the patch cords and turn off the TT-4(\*)/TG's (TM 11-5815-206-12) and the TH-5/TG's (para 29c).

## Section II. PREOPERATIONAL PROCEDURES

### 18. Siting

*a. General.* The location of Operations Central AN/MSC-32 in relation to other components of an area-type communications system depends on the tactical situation and local terrain considerations.

*b. Ground Installation.* When the AN/MSC-32 is to be installed on the mound, locate it on fire, level, dry ground with good drainage. Place the AN/MSC-32 on concrete blocks or wooden beams, if possible, and position it to facilitate connections to the entrance boxes.

*c. Truck Installation.* When the shelter is installed on a truck (para 19), remove the holder assembly from the shelter (fig. 15) and secure it to the tailgate.

*d. Power Unit Location.* An ac source power is required for the AN/MSC-32 (para 21); however, this does not include a generator set as a component. If a generator set is available to supply ac power, locate the generator approximately 75 feet from the AN/ MSC-2 to minimize generator noise interference.

### 19. Installation of AN/MSC-32

*Note.* Four men are needed to install the shelter on the ground or on a truck. A device capable of lifting 3,000 pounds is also required.

*a. Lifting and Loading AN/MSC-32* (fig. 25). If the AN/MSC-32 is to be transported by helicopter, follow only the procedures in (1) through (4) below and observe the airlift warning notice mounted on the outside of the shelter. If the shelter is to be installed on a truck, follow the procedures in (1) through (10) below.

- (1) Use the sling center hooks to connect, the sling assembly to the shelter lifting eyes.
- (2) Place the sling assembly on top of the shelter.
- (3) Connect the four sling hooks to the lifting ring.
- (4) Place the lifting ring over the hook on the lifting device.

**Warning:** To avoid injury to personnel and damage to equipment, only the personnel engaged in the actual loading operation should be permitted near

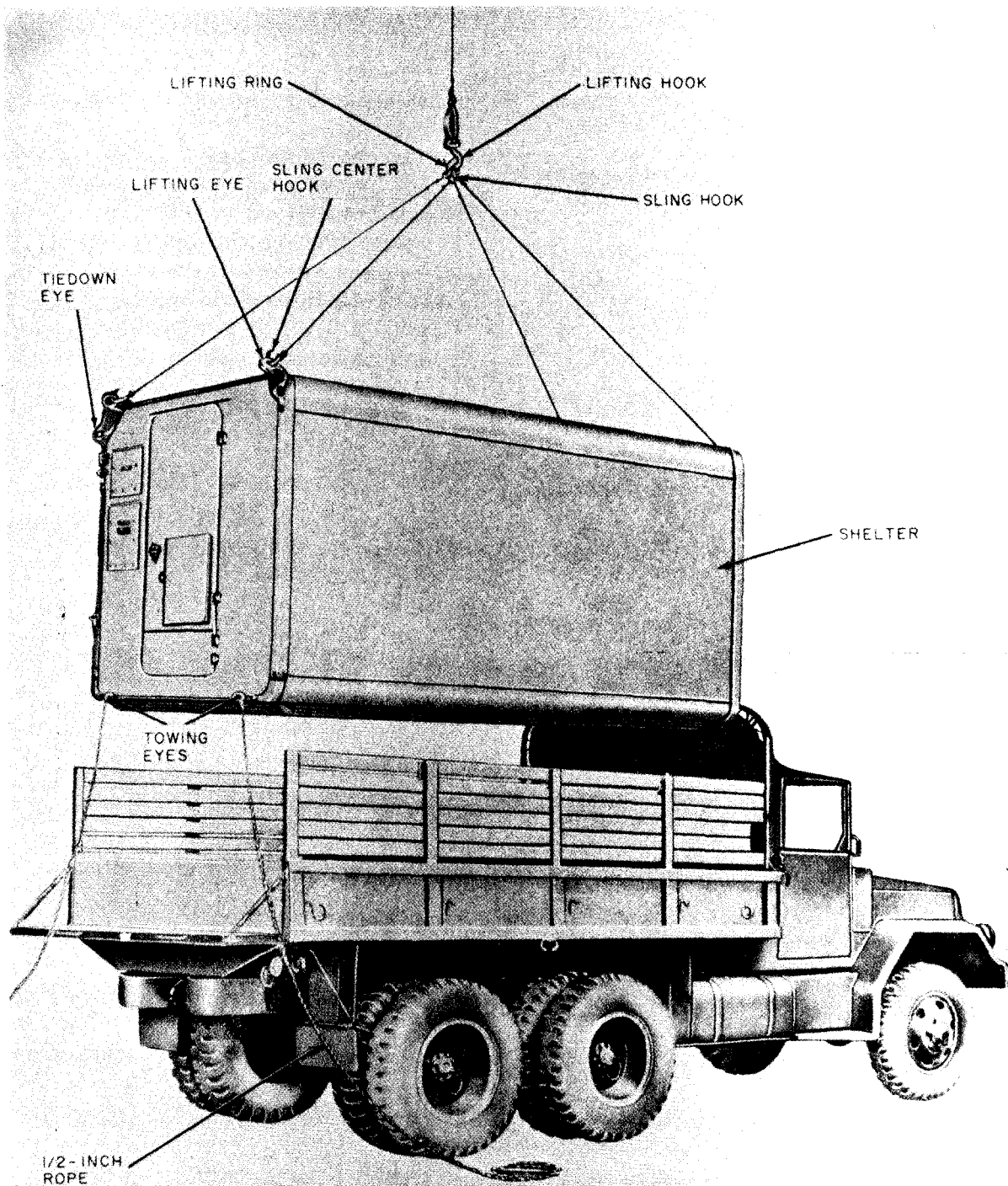

TM5895-224-15-19

Figure 25. Loading AN/MS-32 on truck.

the truck the lifting device, and the shelter. To eliminate confusion, all instructions must come from the loading crew supervisor.

- (5) Tie a 1/2-inch rope (at least 15 feet long) to each rear towing eye.
- (6) Check to see that all tools and equipment are removed from the truck body. Lower the truck tailgate.
- (7) Slowly lift the shelter from the ground to a position high enough to clear the body of the truck.
- (8) Back the truck into position under the shelter.

**Warning:** All personnel must remain clear of the truck while the shelter is being lowered into position.

- (9) Position a man at each of the ropes ((5) above) to guide the shelter

into position, and slowly lower it onto the truck body.

**Note.** The entrance door of the shelter must be at the rear of the truck, and the front of the shelter must be against the front of the truck body.

- (10) Remove the lifting ring from the lifting hook and disassemble the lifting ring and sling hooks. Remove the sling center hooks from the shelter lifting eyes and the ropes from the shelter towing eyes.
- b. *Securing AN/MS-32 on Truck* (fig. 26). Secure the shelter on a truck as follows:
- (1) Use the sling hooks farthest from the turnbuckles and hook each of the four sling hooks to a tiedown eye on the shelter.
  - (2) Use the sling assembly cable attached to the tiedown eye at the

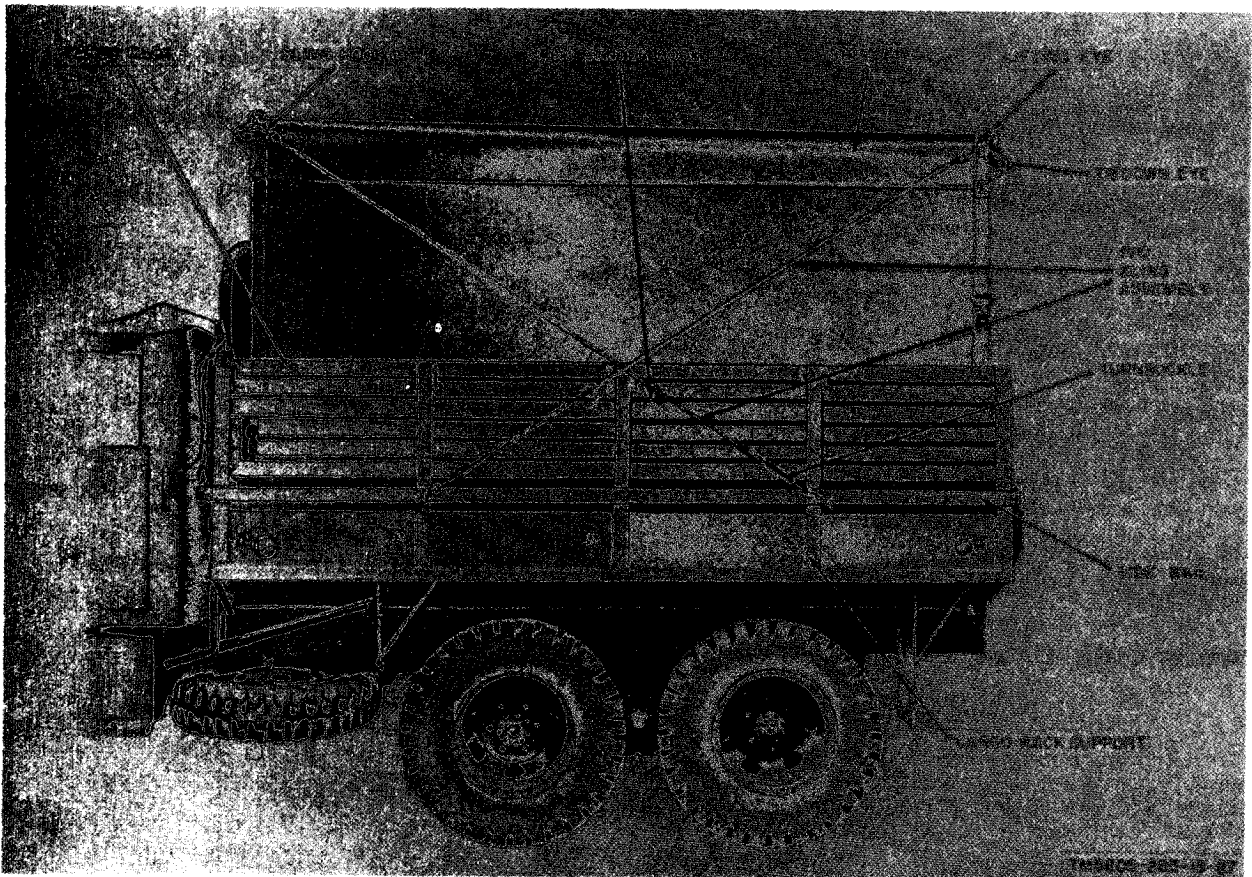

Figure 26. AN/MS-32 secured on truck.

left-front of the shelter, and place the sling hook nearest the turnbuckle under the side rail and behind the second cargo rack support from the rear of the truck.

- (3) Use the sling assembly cable that is attached to the tiedown eye at the left-rear of the shelter, and place the sling hook nearest the turnbuckle under the side rail and in front of the second cargo rack support from the front of the truck.
- (4) Follow the procedures given in (2) and (3) above to secure the right side of the shelter.
- (5) After the sling assembly has been attached to the side rails of the truck, tighten the turnbuckles.

**Caution: Do not overtighten the turnbuckles. To prevent the shelter from twisting in the truck body, equally tighten all the turnbuckles at the same time.**

- (6) Raise and secure the truck tailgate.

*c. Unloading AN/MSC-32.* To unload the AN/MSC-32 from a truck, reverse the procedures described in *a* and *b* above.

## 20. Grounding

The AN/MSC-32 must be properly grounded before input power is connected. Select a grounding site that will not interfere with the entrance door, the field wires, or the power cable. Ground the AN/MSC-32 as follows:

*a.* Loosen the captive screws and lift the cover of the power and signal entrance box (fig. 5).

*b.* Use the cover support to secure the cover in the open position.

*c.* Remove a ground rod and the sledge hammer (fig. 14) from their mountings.

*d.* Select a grounding site within 10 feet of the power and signal entrance box and dig a small hole, about 6 inches deep, at the site.

*e.* Remove any paint or grease from the ground rod.

*f.* Drive the ground rod into the hole until the tip of the ground rod is approximately 3 inches from the bottom of the hole.

*g.* Saturate the ground around the rod with water.

*h.* Remove a 10-foot ground strap (fig. 2) from storage cabinet No. 1.

*i.* Connect one end of the ground strap to the ground rod. Connect the other end of the ground strap to the bottom GROUND TERMINAL in the power and signal entrance box (fig. 8).

*j.* Replace the sledge hammer in its mounting (fig. 14).

## 21. Power Connections

**Caution: Ground the shelter (para 20) before connecting power to the AN/MSC-32.**

Ac power for the AN/MSC-32 may be obtained from a nearby shelter, or from a central or a commercial power source.

### *a. Preliminary Procedure.*

- (1) Operate all circuit breaker and equipment switches to OFF.
- (2) Remove and store the tiedown bar (fig. 3). Remove the power cable assembly and reel from the shelter.
- (3) Unwind the power cable assembly from its reel and remove the connector covers. Store the cable reel.

### *b. Obtaining Power from Adjacent Shelter.*

The total power consumption of the AN/MSC-32 is 4,292 watts. Be sure that the power source output rating for the adjacent shelter is not exceeded when the AN/MSC-32 is connected.

- (1) Operate the MAIN circuit breaker switch on the power distribution panel (fig. 10) to OFF.
- (2) Remove the cover from the IN POWER 115V AC receptacle in the power and signal entrance box (fig. 8) and connect one end of the power cable.
- (3) Remove the cover of the OUT POWER 115V AC receptacle in the power and signal entrance box of the adjacent shelter and connect the other end of the power cable.

### *c. Using Commercial Power.*

- (1) Turn off or disconnect the commercial power before making any connections.
- (2) Remove the power cable stub (fig. 2)

from the storage cabinet. If the power source is a 50- to 60-cycles per second (cps), 120-240-volt, single-phase, three-wire distribution system, connect the red and white leads of the power cable stub to the neutral bus bar and the black lead to one of the 120-volt bus bar of the commercial source.

- (3) If the power source is a 50- to 60-cps, 120-208-volt, 3-phase, four-wire distribution system, connect the red and white leads of the power cable

stub to the neutral bus bar, and the black lead to the phase-1, phase-2, or phase-3 bus bar.

- (4) Remove the cover from the connector of the power cable stub and connect the power cable stub to one end of the AN/MSC-32 power cable assembly.
- (5) Remove the cover from the IN POWER 115V AC receptacle in the power and signal entrance box (fig. 8) and connect the other end of the power cable assembly.

## Section III. SIGNAL CONNECTIONS

### 22. Circuit Connections

Circuits are connected at the AN/MSC-32 with a 26-pair cable at the 26-pair receptacle (fig. 8) or with field wire at the binding post signal entrance box (fig. 9).

*a.* In the power signal entrance box 26-pair receptacle and in the binding post signal entrance box binding posts, the SB-22(\*) /PT lines are terminated on pairs 1 through 12, the No. 1, No. 2, and No. 3 TH-5/TG lines (2W) are terminated on pairs 13, 14, and 15, respectively, and the TT-4(\*)/TG and TT-76(\*)/GGC lines may be terminated on pairs 16 through 21, as desired.

*b.* In the power and signal entrance box, the local telephone lines (TA-312/PT) are terminated on pairs 22 through 25. The intercommunication line (LS-147(\*)/FI) is terminated on pair 26.

*c.* Refer to paragraph 23 for 26-pair cable connecting procedures.

### 23. Connection Procedure for 26-Pair Cables

To couple a connector of a 26-pair cable to a connector of another 26-pair cable (such as Cable Assemblies, Telephone CK-4566/U (250 ft) and CX-4760/U (15 ft) (fig. 2)), use the procedure in *a* below. To couple a connector on a 26-pair cable to the receptacle in the power and signal entrance box (fig. 8) use the procedure in *b* below.

#### *a. Coupling 26-Pair Connectors (fig. 27).*

**Caution:** Handle the 26-pair connectors carefully during the coupling and uncoupling procedures. Do not force or twist the connectors during installation. Never drop or place an uncovered 26-pair connector on the ground.

#### (1) *Cover removal.*

- (a) Grasp the knurled collar on each end of the connector and turn the collars until the open position is reached (A).
- (b) Disengage the cam on top of the cover from the slot on the connector collar. Lift and remove the cover (B).

#### (2) *Coupling procedure.*

- (a) Position the two 26-pair connectors so that the cams drop into the slots of the knurled collars and the male contacts are aligned with the female contacts (C).
- (b) Carefully press the two connectors together (D).
- (c) Lock the two connectors by turn the knurled collars until the closed position is reached (E).
- (d) Lock the two connector covers together.

#### (3) *Uncoupling procedure.*

- (a) Unlock the 26-pair connectors by turning the knurled collars until the open position is reached (A).
- (b) Carefully pull the connectors apart.

(4) *Cover replacement.*

- (a) Unlock the two connector covers.
- (b) Position the cover on top of the 26-pair connector.
- (c) Engage the cam on the top of the cover in the slot on the connector collar (A).
- (d) Lock the cover to the connector by turning the collars until the closed position is reached.

*b. Coupling 26-Pair Connector to 26-Pair Receptacle* (fig. 28). The removal and replacement procedures for a 26-pair receptacle (A through D) are the same as those described for the 26-pair connector (a(1) above). Connect and disconnect a 26-pair connector at the 26-pair receptacle as follows:

**Note.** The cable end of the connectors is used as a reference for clockwise or counterclockwise rotation.

(1) *Connecting procedure.*

- (a) Remove the covers and lock them together.
- (b) Position the 26-pair connector on the receptacle so that the cams

drop into the slots of the knurled collars, and the male contacts are aligned with the female contacts (E and F).

- (c) Carefully press the connector into the receptacle (G).
- (d) Turn the lever on the receptacle knurled collar counterclockwise until the collar just engages the cam.
- (e) Turn the knurled collar on the connector clockwise until the sleeve just engages the cam.
- (f) Simultaneously turn the receptacle collar lever and the connector collar until the closed position is reached (G).

(2) *Disconnecting procedure.*

- (a) Simultaneously turn the receptacle collar lever and the connector collar until the open position is reached.
- (b) Carefully pull the connectors apart.
- (c) Replace the covers (a(4) above).

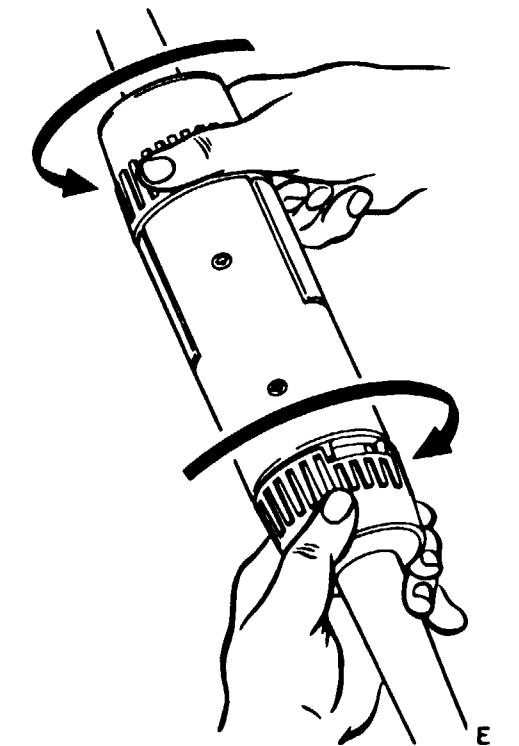
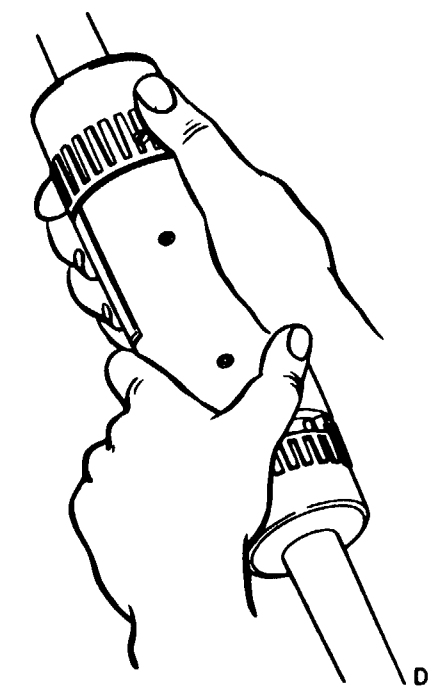
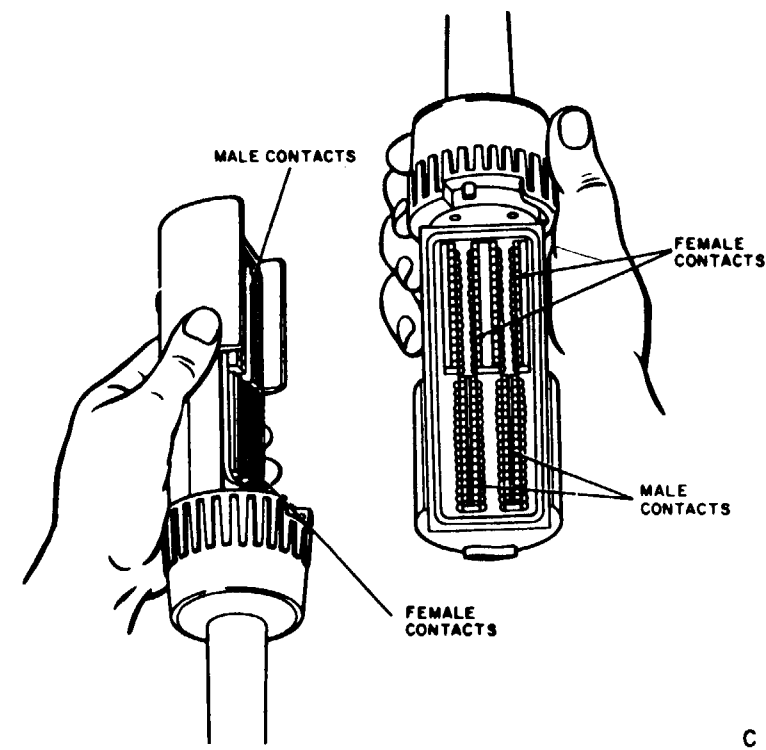
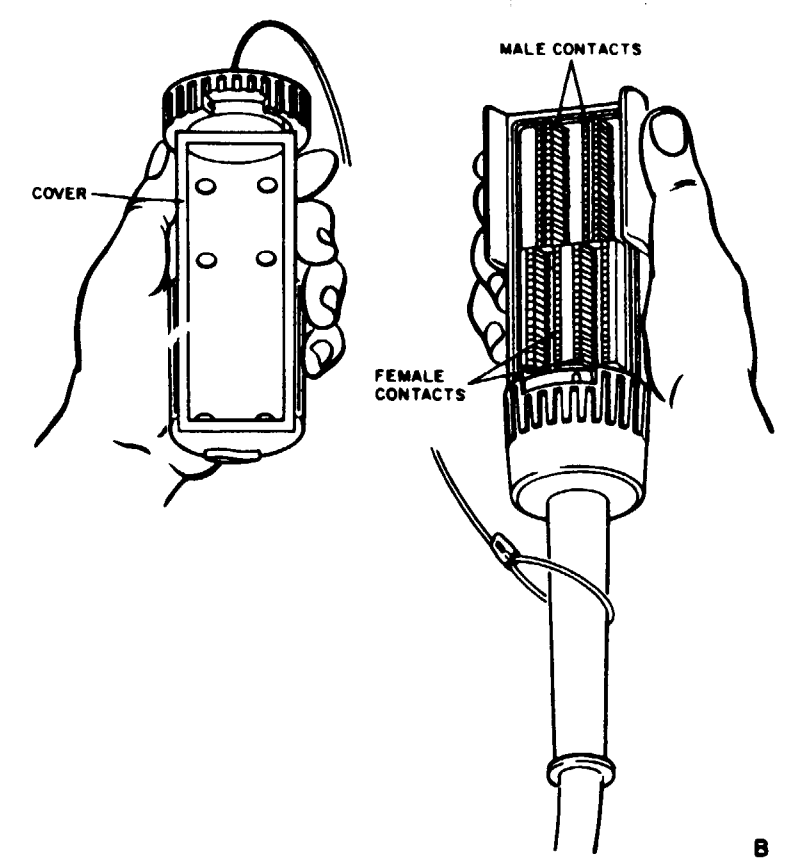
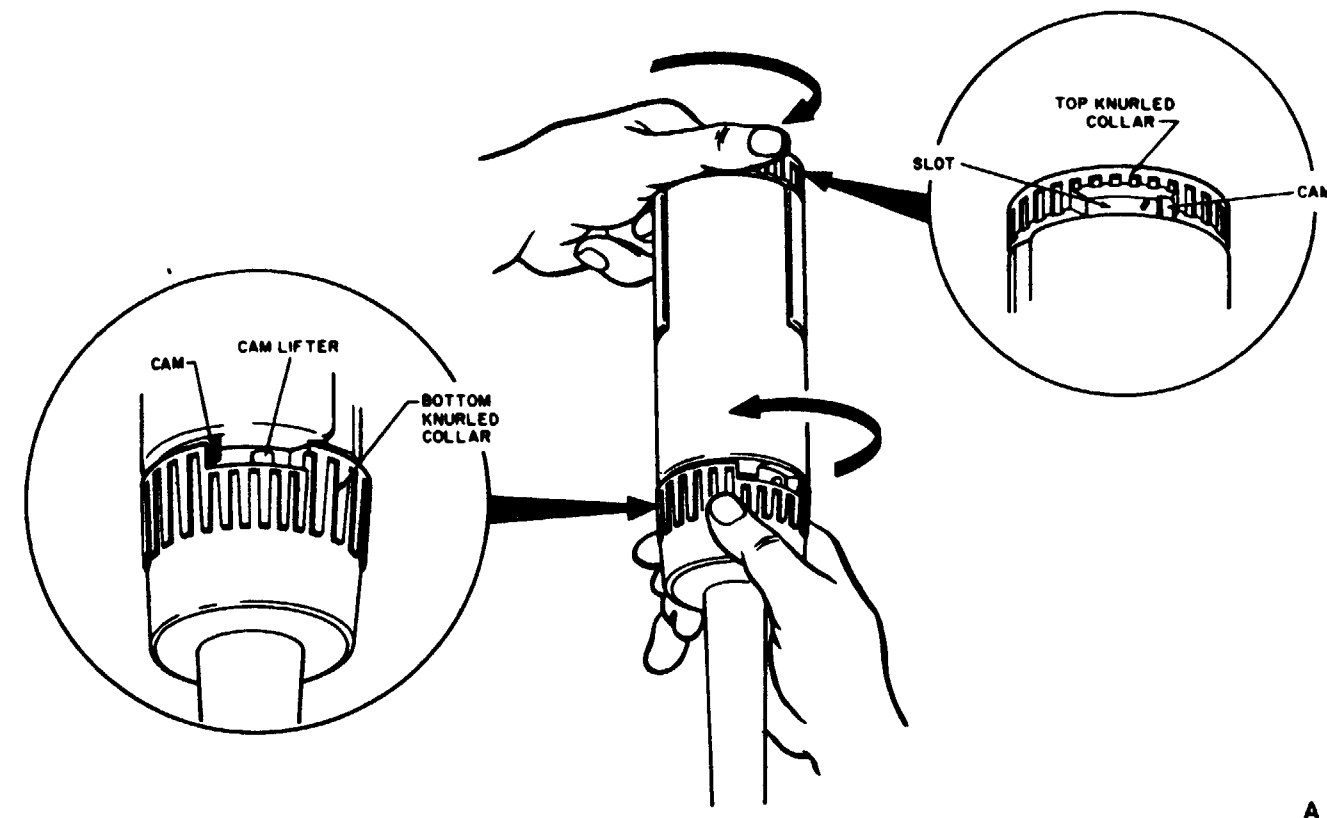
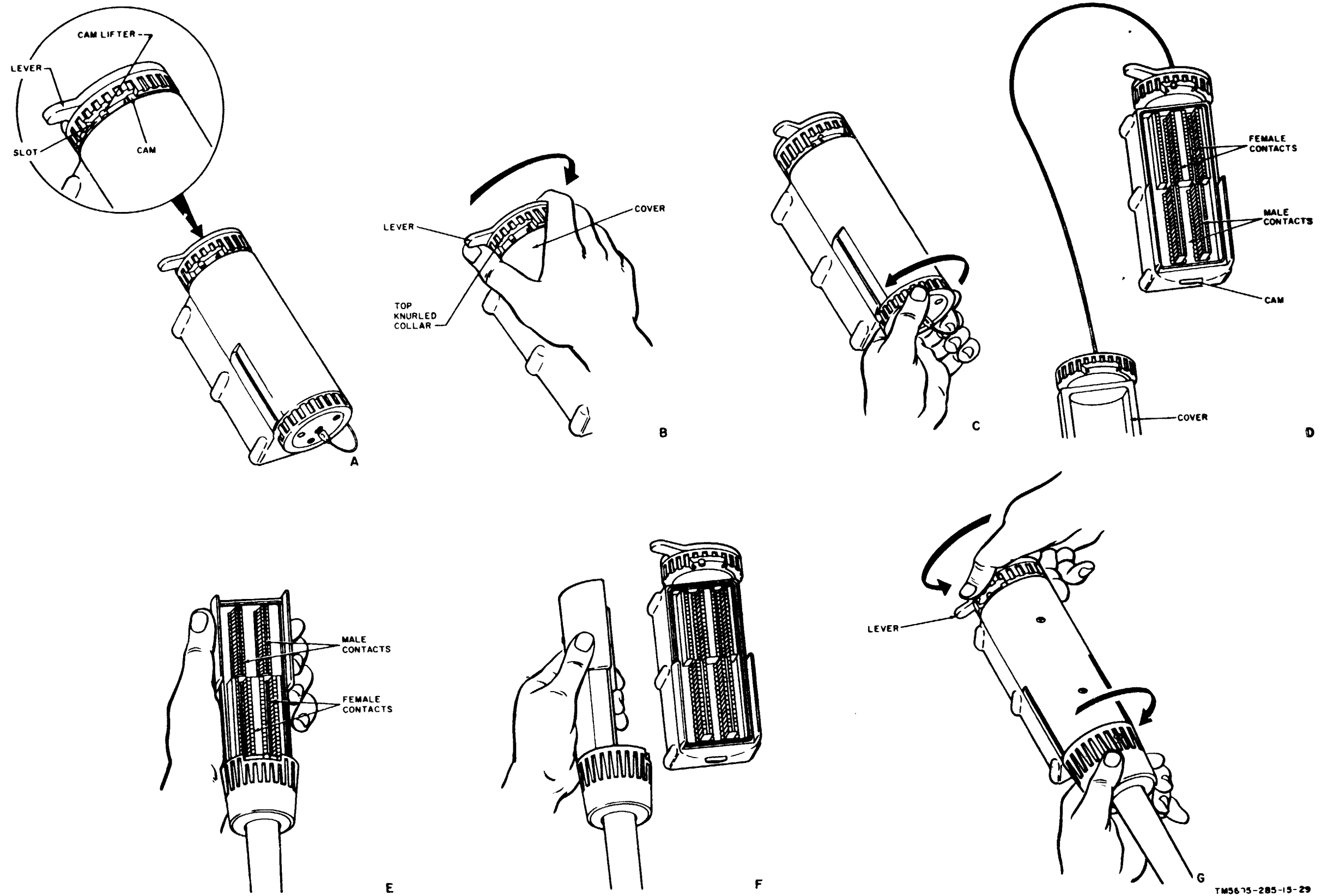

Figure 27. Coupling 26-pair connectors.





TM56-15-285-15-29

Figure 28. Connecting 26-pair connector to the 26-pair receptacle

## CHAPTER 3

### OPERATING INSTRUCTIONS

#### 24. General

This chapter contains operating procedures for S-184/MS-32 shelter component. Operating procedure for the major components are contained in the applicable technical manuals (appx I).

#### 25. Controls and Instruments

The following are the descriptions and functions of the controls and instruments of the shelter components. For information concerning the controls and instrument of the major components, refer to the applicable technical manuals (appx I).

*a. Power Distribution Panel (fig. 10).*

Control, indicator, or instrument	Description and function
<b>MAIN circuit breaker switch.</b>	Two internally ganged 50-ampere circuit breaker switches. Provides overload protection for 115-volt, ac input source and ON-OFF control of ac power to individual circuit breaker switches.
<b>Individual circuit breaker switches:</b>	Provide ON-OFF control and overload protection for individual circuits as follows:
	<i>Rating                      Circuit</i> <i>(amperes)</i>
<b>1 LIGHTS</b> .....	<b>15</b> Fluorescent lights.
<b>2 BLOWERS</b> .....	<b>15</b> Exhaust blowers No. 1 and No. 2 receptacles.
<b>3 HEATER 1</b> .....	<b>20</b> Electric heater No. 1 receptacle.
<b>4 CONVENIENCE</b>	<b>20</b> Convenience receptacles.
<b>5 EQUIPMENT</b> ..	<b>15</b> Equipment receptacles.
<b>6 HEATER 2</b> .....	<b>20</b> Electric heater No. 2 receptacle.

Control, indicator, or instrument	Description and function
<b>AC VOLTS meter (voltmeter).</b>	Ac voltmeter with 0- to 150-volt scale. Indicates ac input voltage from external power source.
<b>AC AMPERES meter (ammeter).</b>	Ac ammeter with 0- to 50-ampere scale. Indicates total current drain from external power source by AN/MS-32 components in use.
<b>Glowlamps (1 through 6)</b>	Neon lamp. Glows when associated circuit breaker switch is on.

*b. Lighting (fig. 13,14, and 16).*

Control or indicator	Description and function						
<b>BLACKOUT BYPASS switch (fig. 14).</b>	Two-position ON-OFF switch. Controls lighting in the AN/MS-32 for blackout operation as follows:  <table style="margin-left: 20px; border: none;"> <tr> <td style="text-align: right;"><i>Sw pos</i></td> <td style="text-align: right;"><i>Permits</i></td> </tr> <tr> <td style="text-align: right;">ON</td> <td>Fluorescent lights to be controlled by the individual light switches.</td> </tr> <tr> <td style="text-align: right;">OFF</td> <td>Fluorescent lights to be controlled by door micro-switch.</td> </tr> </table>	<i>Sw pos</i>	<i>Permits</i>	ON	Fluorescent lights to be controlled by the individual light switches.	OFF	Fluorescent lights to be controlled by door micro-switch.
<i>Sw pos</i>	<i>Permits</i>						
ON	Fluorescent lights to be controlled by the individual light switches.						
OFF	Fluorescent lights to be controlled by door micro-switch.						
<b>POWER INDICATOR NEON LAMP (fig. 14).</b>	Neon lamp. Lights when ac power is connected to the AN/MS-32.						
<b>Door microswitch (fig. 14).</b>	Microswitch. Extinguishes fluorescent lights when shelter door is opened. (BLACKOUT BYPASS switch in OFF position.)						
<b>LIGHT 1 switch (fig. 14).</b>	Two-position ON-OFF switch. Controls two fluorescent lights in each row (fig. 16).						

Control or indicator	Description and function
LIGHT 2 switch (fig. 14).	Two-position ON-OFF switch. Controls two fluorescent lights in each row.
NIGHT LIGHT switch (fig. 13).	Two-position ON-OFF switch. Controls nightlight.
Spotlight switch (fig. 16).	Two-position ON-OFF switch. Controls spotlight.

*c. Exhaust Blowers (fig. 16).*

Control	Description and function
BLOWER 1 switch ---	Two-position ON-OFF switch. Controls operation of exhaust blower No. 1.
BLOWER 2 switch ---	Two-position ON-OFF switch. Controls operation of exhaust blower No. 2.

*d. Electric Heater (fig. 17).*

Control	Description and function								
HEAT-OFF-FAN switch.	<p>Three-position toggle switch.</p> <table border="1"> <thead> <tr> <th>Sw pos</th> <th>Function</th> </tr> </thead> <tbody> <tr> <td>HEAT</td> <td>Applies ac power to heater element and fan motor.</td> </tr> <tr> <td>OFF</td> <td>Disconnects ac power from heater element and fan motor.</td> </tr> <tr> <td>FAN</td> <td>Applies ac power to fan only.</td> </tr> </tbody> </table>	Sw pos	Function	HEAT	Applies ac power to heater element and fan motor.	OFF	Disconnects ac power from heater element and fan motor.	FAN	Applies ac power to fan only.
Sw pos	Function								
HEAT	Applies ac power to heater element and fan motor.								
OFF	Disconnects ac power from heater element and fan motor.								
FAN	Applies ac power to fan only.								
TEMPERATURE CONTROL.	Thermostat control. Regulates the temperature provided by the heating element.								
RESET pushbutton ---	Pushbutton which resets the protective circuit breaker within heater.								

*e. LS-147(\*)/FI (fig. 18).*

Control or indicator	Description and function
OFF-SEND control ---	Ganged on-off potentiometer. Turns ac power on and off

Control or indicator	Description and function
	and controls volume of output signal. Switch must be on to originate a call.
PRESS TO TALK switch.	Two-position nonlocking switch. Switch must be pressed to originate a call.
RECEIVE control ----	Potentiometer. Controls speech volume from loudspeaker.
Glowlamp -----	Neon lamp. One-half of lamp glows when internal dc power supply is operating.

*f. Patch Panel (fig. 19).  
(1) Jackstrip No. 1.*

Jack	Function
TH-5/TG: 1, 2, and 3.	Cutoff jacks. Used to patch the 2-wire line output of the indicated TH-5/TG (normally connected to line pairs 13, 14, and 15, respectively) to another line or shelter equipment.
TT-4A/TG #1:	
SEND 10 -----	Terminating jack. Used to patch the TT-4(*)/TG No. 1 send circuit to a TH-5/TG SEND jack or line circuit.
REC 11 -----	Terminating jack. Used to patch the TT-4(*)/TG No. 1 receive circuit to a TH-5/TG REC jack or a line circuit jack.
TT-4A/TG #2:	
SEND 12 -----	Terminating jack. Used to patch the TT-4(*)/TG No. 2 send circuit to a TH-5/TG SEND jack or line circuit.
REC 13 -----	Terminating jack. Used to patch the TT-4(*)/TG No. 2 receive circuit to a TG-5/TG REC jack or a line circuit.
TT-76/GGC:	
TD 14 -----	Terminating jack. Used to patch the TT-76(*)/GGC transmitter-distributor circuit to a TH-5/TG SEND jack or a line circuit.
TR15 -----	Terminating jack. Used to patch the TT-76(*)/GGC keyboard

Jack	Function.
REC 16 -----	Terminating jack. Used to patch the TT-76(*)/GGC receive circuit to a TH-5/TG REC jack or a line circuit.

(2) Jackstrip No. 2.

Jack	Function
<b>LINES SB-22/PT:</b> 1 through 12.	Cutoff jacks. Used to patch the indicated line (normally connected to the indicated SB-22(*)/PT line circuit) to other shelter equipment or line circuit.
<b>LINES TH-5/TG:</b> 13, 14, and 15.	Cutoff jacks. Used to patch the indicated line (normally connected to TH-5/TG No. 1, 2, and 3, respectively) to another shelter equipment.
<b>LINES SPARES:</b> 16 through 21.	Terminating jacks. Used to patch the indicated line to shelter equipment.
<b>PHONE:</b> 1 through 4.	Terminating jacks. Used to connect in parallel with the PHONE 1 through PHONE 4 jacks in the signal ducts (h below).

g. Teletypewriter Patch Panel (fig. 20).

Jack	Function
<b>TT-4A/TG #1 and TT-4A/TG #2: SEND and REC.</b>	Terminating jacks. Used to connect send and receive circuits of the indicated TT-4(*)/TG to similarly marked jacks at the patch panel (f(1) above).
<b>TT-76: TD, TR, and REC.</b>	Terminating jacks. Used to connect the transmitter-distributor, keyboard, and receive circuit, respectively, of the TT-76 (*)/GGC to similarly marked jacks at the patch panel (f(1) above).

h. Signal Duct Jacks (fig. 11, 12, and 13).

Jack	Function
<b>PHONE 1, PHONE 2, PHONE 3, and PHONE 4.</b>	Terminating jacks. Used to connect the LINE circuit of a TA-312/PT (fig. 24) to similar-

Jack	Function
INTERCOM -----	ly marked jacks at the patch panel (e above) and to line circuits. Terminating jacks connected in parallel. Used to connect LS-147 (*)/F I to intercom line between shelters.

i. TH-5/TG Subdistribution Panel (fig. 21).

Control, indicator or receptacle	Function
ON-OFF switch ----	Each switch controls ac power to associated receptacle.
Glowlamp -----	Each glowlamp lights when associated ON-OFF switch is operated to ON.
Receptacle -----	Each receptacle is used as a connection for ac power cord connector of a TH-5/TG.

## 26. Energizing Ac Circuits

**Warning:** To prevent asphyxiation, the shelter must be ventilated at all times when occupied.

Prepare the AN/MS-32 for full operation as follows:

a. Connect the AN/MS-32 to the available power source (para 20); the POWER INDICATOR NEON LAMP (fig. 14) will light.

b. Operate the MAIN circuit breaker switch on the power distribution panel (fig. 10) to ON.

c. Operate the BLACKOUT BYPASS switch (fig. 14) to ON. When blackout conditions are required, operate the switch to OFF.

d. Operate circuit breaker switch No. 1 (LIGHTS) to ON.

e. Operate the LIGHT 1 and LIGHT 2 switches (fig. 14) to ON. Operate the NIGHT LIGHT switch (fig. 14) to ON as required.

f. Check to see that the voltmeter (fig. 10) indicates 115 volts ac  $\pm 10$ .

g. Check to see that the ammeter indicates nearly 0 ampere.

h. Operate circuit breaker switches No. 2 through 6 to ON.

## 27. Operating Procedures

**Notes.** Refer to the applicable technical manuals (appx I) for operating procedures for the major components. Refer to paragraph 25 for descriptions and functions of controls and instruments of shelter components.

**Warning:** To prevent asphyxiation, the shelter must be ventilated at all times when occupied.

a. *Electric Heater* (fig. 17). Insert the power cord connector plug into the appropriate HEATER receptacle (fig. 11 and 14) and operate the HEAT-OFF-FAN switch to the desired position. When the HEAT-OFF-FAN switch is operated to HEAT, set the TEMPERATURE CONTROL to the desired setting.

**Caution:** Before performing the procedure in *b* below, open the air vent cover (fig. 5) and the exhaust blower vent cover on the front of the shelter. If the covers are not opened, the motors will be damaged from overheating.

b. *Exhaust Blowers* (fig. 17). Connect the power cord connector plug into the appropriate blower receptacle (fig. 16) and operate the BLOWER switch to ON.

c. *Intercommunication Station LS-147(\*)/FI* (fig. 18).

- (1) Insert the power cord connector plug into the INTERCOM power duct receptacle (fig. 16) and connect the ground lead to the ground terminal provided adjacent to the receptacle.
- (2) Insert the telephone connecting cord plug into the INTERCOM signal duct jack below the SB-22(\*)/PT (fig. 13).
- (3) Operate the OFF-SEND switch to 5 (approximately midposition). The glowlamp will light.
- (4) Operate the PRESS TO TALK switch and speak into the speaker-microphone on the front panel; release the PRESS TO TALK switch to receive.

**Notes.** The OFF-SEND switch does not have to be operated to receive a call.

- (5) Operate the RECEIVE control to regulate the volume of an incoming call.

**Notes.** The LS-147(\*)/FI may be moved to an operating position on the roadside tabletop

(fig. 12) by removing it from its mounting position (para 40). Insert the power cord connector plug and the telephone connecting cord into the appropriate CONVENIENCE 4 receptacle and INTERCOM jack, respectively; connect the power cord ground lead.

d. *TH-5/TG Subdistribution Panel* (fig. 21).

- (1) Insert the TH-5/TG subdistribution panel power cord connector plug into the TH-5/TG receptacle (fig. 12).
- (2) Operate the ON-OFF switch to apply power to the TH-5/TG No. 1, 2, and 3 (*e* below) connected to the associated receptacle. The associated glowlamp lights.

e. *Terminal, Telegraph TH-5/TG* (fig. 13). Use the following procedures for each TH-5/TG (TM 11-5805-246-10).

- (1) Insert the power cord connector plug into the associated receptacle in the TH-5/TG subdistribution panel (*d* above) and apply power to the TH-5/TG.
- (2) Operate the 4W-2W-TEL switch to 2W and the NORM-REC-SEND switch to NORM. Operate the RING switch to transmit a ringing signal.

f. *PHONE 1 Through PHONE 4 TA-312/PT* (fig. 24).

- (1) For PHONE 1 TA-312/PT, insert the telephone connecting cord into the PHONE 4 jack (fig. 13), and operate the TA-312/PT as desired (TM 11-2155).
- (2) For PHONE 2, 3, and 4 use, perform the procedures given in paragraph 12a.

g. *Distribution Box J-1077A/U* (fig. 13).

- (1) Loosen the web straps and remove the J-1077A/U from its mounting.
- (2) Disconnect the 26-pair cable connectors at the junction point (para 23a(3)).
- (3) Remove the J-1077A/U 26-pair receptacle covers.
- (4) Connect the 26-pair cable connector to the J-1077A/U receptacles (para 23a(2)).
- (5) Release the J-1077A/U cover fasteners and open the cover.

- (6) Connect field wire to the terminals as desired.

*h. Patching* (fig. 19). The SB-22(\*)/PT, TH-5/TG line, PHONE 1 through PHONE (TA-312/PT), and INTERCOM (LS-147(\*)/FI) circuits are connected directly to their assigned lines and no patching is required. Teletypewriter circuits are established on a direct-current (dc) or vf basis by patching. Perform the following procedures at the patch panel:

(1) *Vf half-duplex teletypewriter operation.*

- (a) Patch the TT-4A/TG (#1 or #2) SEND jack or the TT-76/GGC TR and TD (as desired) jacks to the SEND jack of a TH-5/TG (No. 1, 2, or 3).

- (b) Patch the TT-4A/TG (#1 or #2) REC jack or the TT-76/GGC REC jack to the REC jack of a TH-5/TG (No. 1, 2, or 3).

(2) *Dc teletypewriter operation.* Patch, as desired, any TT-4A/TG (#1 and #2) jack and TT-76/GGC jack to a LINES SPARES (16 through 21) jack: or, if required, to any LINES SB-22/PT (1 through 12) jack. In the latter case, the associated line jack on the SB-22(\*)/PT is disconnected from its assigned line circuit.

(3) *Telephone net.* Patch PHONE 1, 2, 3, or 4 jack to another PHONE jack, a LINES SPARES (16 through 21) jack, or a LINES SB-22/PT (1 through 12) jack. In the latter case, the associated line jack on the SB-22(\*)/PT is disconnected from the assigned line circuit.

## 28. Operation Under Adverse Climatic Conditions

Operations Central AN/MSC-32 can be operated in extremely cold or hot climates. The shelter offers complete protection from the elements for personnel and equipment; however, when the entrance boxes are exposed to adverse conditions, the following precautions are necessary:

*a. Cold Climates.* Extreme cold causes the

cables and wires to become hard, brittle, and difficult to handle. Be careful when handling the cables and when connecting them to the AN/MSC-32 so the kinks and unnecessary loops will not result in permanent damage. Make sure that the binding posts and cable receptacles on the outside of the AN/MSC-32 are free of frost, snow, and ice by replacing the covers on the receptacles and closing the covers on the entrance boxes when they are not in use. Lower the folding side panels when the entrance box covers are open. Replace the connector cover as soon as the connector is disconnected from the equipment; never drag or place an open connector in the snow.

*b. Hot Climates.* In hot, dry climates, the connectors, receptacles, and binding post are subject to damage from dirt and dust. Lower the folding side panels when the entrance box covers are open. Close the covers on the entrance boxes when they are not in use and replace the covers on the cable connectors. Never drag or place an open connector on the ground.

*c. Warm, Damp Climates.* In warm, damp climates, the equipment is subject to damage from moisture and fungi. Wipe all moisture and fungi from the exterior of the equipment with a lint-free cloth.

## 29. Stopping Procedures

**Notes. To turn off the power in an emergency, operate the MAIN circuit breaker switch to OFF.**

*a. Major Components.* Stopping procedures are not required for the SB-22(\*)/PT, or the TA-312/PT. Refer to the appropriate technical manuals for teletypewriter equipment stopping procedures (appx I). Refer to paragraph 57 for procedures to be performed for storage or transit of the AN/MSC-32.

*b. S-184/MSC-32 Components.*

- (1) *Electric heaters.* Operate the TEMPERATURE CONTROL to its lowest setting and the HEAT-OFF-FAN switch to OFF.
- (2) *Intercommunication Station LS-147 (\*)/FI.* Operate the OFF-SEND switch to OFF.

**Notes. After the other S-184/MSC-32 components ((1) and (2) above) have been turned off, allow the exhaust blowers to remain in**

operation for at least 10 minutes to evacuate all smoke and fumes before completing the stopping procedures and closing the shelter door.

- (3) *Exhaust Blowers.* Operate the BLOWER 1 and BLOWER 2 switches to OFF.

- c. *TH-5/TG Subdistribution Panel.* Operate the ON-OFF switches to OFF. The associate glowlamp is extinguished.

- d. *Circuit Breaker and Light Switches.* Operate all circuit breaker and light switches to OFF.

## MAINTENANCE INSTRUCTIONS

## Section I. OPERATOR'S MAINTENANCE

## 30. General Maintenance

Clean and inspect all component of the AN/ MSC-32 regularly. Detailed maintenance procedures pertaining to the major components are covered in the appropriate technical manuals (appx I).

*a.* Use a clean, dry, lint-free cloth or brush for dusting.

*b.* For cleaning, if necessary, moisten the cloth or brush with Cleaning compound (FSN 7930-395-9542); after cleaning, wipe dry with a cloth. Do not use cleaning compound on electrical contacts.

**Warning:** Cleaning compound is flammable and its fumes are toxic. Do not use near a flame; provide adequate ventilation.

*c.* Dry, compressed air, not exceeding 60 pounds per square inch, may be used to remove dust from inaccessible places.

**Warning:** Compressed air is dangerous and can cause serious damage to eyes, ears, nose, and other parts of the body. It also can cause mechanical damage to the equipment. Do not use compressed air to dry parts where cleaning compound has been applied.

## 31. Tools and Materials Required

*a. Tools and Test Equipment.* The tools and test equipment required for maintenance of the major components are listed in the applicable technical manuals (appx I). The tool kit (fig. 2) is required for maintenance of the S-184/MSC-32.

**Notes.** A list of running spares required for operator's maintenance of the AN/MSC-32 is contained in appendix III.

*b. Materials.*

Item	Federal stock No.
Abrasive, sheet: sandpaper #0000; 9 x 12 in. sheets	6627500-0000*
Cloth, textile: cheesecloth ; lint-free ; 86 in.	408-2701 <sup>b</sup>
Orangestick	5120-408-4086
Tape TL-88	5970-184-2008
Cleaning compound	7980-395-9542
Abrasive, sheet : crocus 9 x 11 in.	(Ord) <sup>d</sup>
Grease, graphite, aircraft MIL-G-7187 (GGA)	9150-228-4001*
Lubricating oil, internal combustion engine MIL-L-2104A (OE-10)	9150-265-9425*
Polish, metal : paste	9G1516*
Lubricating oil, general purpose, preservative MIL-L344A (PL special)	9150-278-2889*

\* Signal Corps stock number.

<sup>b</sup> Interim Federal stock number.

<sup>c</sup> Quartermaster Corps stock number.

<sup>d</sup> Ordnance Corps items.

## 32. Daily Preventive Maintenance

*a.* Check for completeness and general condition of the equipment and spare parts.

*b.* Remove dirt, dust, grease, and moisture from the exposed parts.

*c.* Remove rust, corrosion, fungi, dirt, and moisture from the binding posts, cable connectors, and receptacles.

*d.* Inspect the field wire connections at the binding posts for good contact.

*e.* Inspect the ground rods and ground strap connections for good contact.

*f.* Inspect all exposed cables for kinks,



strains, moisture, fungi, loose terminals, and for frayed, cut, or damaged insulation.

*g.* Tighten loose mounting hardware.

### 33. Weekly Preventive Maintenance

*a.* Clean and tighten the components, racks, mountings, installations, cables, and connectors.

*b.* Inspect the components, racks, mountings, installations, and exposed metal surfaces for rust, corrosion, and moisture.

*c.* Inspect the cables and wires for cuts, breaks, fraying, deteriorations, kinks, and strain.

*d.* Inspect for looseness of accessible items, such as component switches, circuit breaker switches, signal and ac cable assemblies, and glowlamps.

*e.* Clean the air filter, nameplates, meters, and clock.

*f.* Inspect meters and clock for damaged glass and cases.

*g.* Wind the clock (fig. 13).

*h.* Inspect the shelter for support, installation, rust, corrosion, and moisture.

*i.* Check the entrance boxes, exhaust blower vents, and air filter intake for cracks, leaks, damaged gaskets, dirt, and grease.

*j.* Check for normal operation.

### 34. Monthly Preventive Maintenance and Lubrication

*a.* Lubricate locks and latches. Use grease, graphite, aircraft (GGA).

*b.* Lubricate the hinges on the shelter door and on the entrance boxes, exhaust blower

vent, and air vent covers. Use oil (PL special or OE-10).

*c.* Lubricate all metal-to-metal moving parts.

**Caution:** More frequent lubrication may be required for items listed above in excessively hot, humid, or dusty areas. Do not overlubricate.

*d.* Remove the shelter air vent filter (fig. 14) and soak it in cleaning compound, benzine, or naphtha. Shake loose dirt from the air filter, air-dry the filter, and replace it in its mounting.

*e.* Check the fire extinguishers (fig. 11 and 14) for a broken wire seal on the trigger mechanism. If an extinguisher has been used, or if there are any signs of leakage, request that it be recharged by appropriate personnel.

### 35. Equipment Performance Checklist

The equipment performance checklist is used to systematically check the AN/MS-32. Only first echelon maintenance corrective measures are given in the *Corrective measures* column. If the corrective measures given do not correct the fault, request higher echelon maintenance. When using the checklist, start at the beginning and follow each step consecutively. If the trouble is suspected in a particular area, start checking at that point and continue the steps sequentially. Refer to the power schematic-wiring diagram (fig. 41) when checking the S-184/MS-32 ac circuits. When a fault or trouble is located in a major component item, refer to the applicable technical manual (appx I). First echelon repair procedures are given in paragraphs 36 through 45.

Item No.	Item	Action or condition	Normal indication	Corrective measures
P R E P A R A T O R Y	Ac circuits -----	All equipment and power duct switches at OFF; energizes ac circuits in the sequence given in paragraph 26.	As each circuit breaker switch is operated to ON, associated glowlamp lights.	<p><i>a.</i> Reset circuit breaker switch.</p> <p><i>b.</i> Check ac power source. Check power cable assembly and replace if defective.</p> <p><i>c.</i> Perform appropriate repair procedure (para 36 through 42).</p>

m o.	Item	Action or condition	Normal indication	Corrective measures
E 2 E Q U I P M E N T  P E R F O R M A N C E	Shelter components.	Operate as outlined in paragraph 27.	Component functions; glow-lamps associated with LS-147 (*)/FI and TH-5/TG subdistribution panel light. As components are operated, current indication on power distribution panel ammeter increases (approximately 3 amperes for each blower and 10 amperes for each electric heater).	<p>a. Replace fuses or lamp (para 37) and press RESET pushbutton (fig. 17) on electric heaters, as required.</p> <p>b. Perform appropriate repair procedure (para 37 through 42).</p>
E 3 E Q U I P M E N T  P E R F O R M A N C E	Major components.	Operate major components as outlined in appropriate technical manuals (appx I).	Communication is possible on all signal circuits connected to the AN/MSC-32.	<p>a. Check suspected major component for proper connections (para 11 through 16).</p> <p>b. Check signal connections to AN/MSC-32 (para 22).</p> <p>c. Perform operator's maintenance as outlined in appropriate technical manual (appx I).</p>
S 4 S T O P	Major components.	Refer to appropriate technical manuals (appx I) for stopping procedure.		
5	Shelter components.	Perform stopping procedure as outlined in paragraph 29.		

### 36. Replacement of Hand Lantern Batteries and Bulb

(fig. 29)

The hand lantern requires four Batteries BA-30 which are not supplied with the lantern. A spare bulb is stored inside the reflector case.

#### a. Replacing Batteries.

- (1) Pull the latch forward and raise the battery case cover.
- (2) Insert four batteries in the case with the center brass caps up.
- (3) Snap the battery case cover shut.

#### b. Replacing Bulb.

- (1) Press the button on the bottom of the reflector case and lift out the reflector.
- (2) Unscrew the brass cap at the rear of the bulb and remove the bulb and spring.
- (3) Remove the spare bulb from the inside of the reflector case. Insert the bulb and spring in the reflector and tighten the brass cap.
- (4) Replace the reflector in the reflector

case and snap it securely in position.

### 37. Removal and Replacement of Lamps and Fluorescent Lamp Starters

#### a. Fluorescent Lamp.

- (1) Pull gently to remove the light shield from the fluorescent light fixture.
- (2) Rotate the lamp in its sockets one-quarter turn and remove it from the fixture.
- (3) Remove the spare lamp from its storage brackets (fig. 16).
- (4) Align the lamp with the slots in the fixture sockets.
- (5) Press in and rotate the lamp one-quarter turn to seat the pins firmly.
- (6) Replace the light shield on the fluorescent light fixture.

#### b. Fluorescent Lamp Starter.

- (1) Remove the light shield and lamp (a(1) and (2) above) to expose the starter.
- (2) Press in and twist the starter one-quarter turn counter-clockwise and

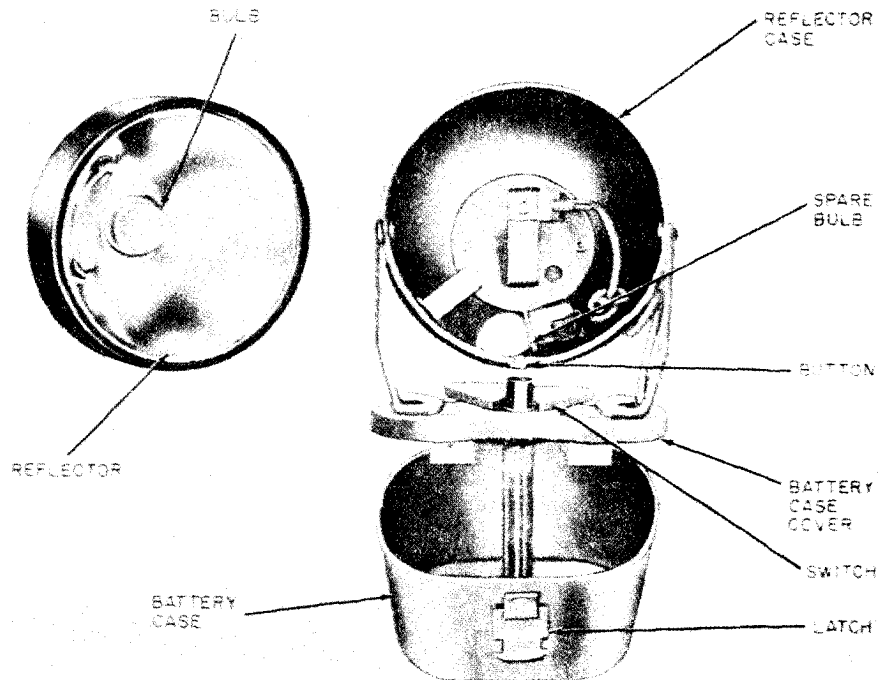

TM5603-285-15-30

Figure 29. Hand lantern, partially disassembled.

withdraw it.

- (3) Remove the spare starter from its storage bracket (fig. 16). Insert the new starter, press in, and turn it clockwise until it seats.
- (4) Replace the lamp and light shield (a(4) through (6) above).

*c. Neon and Incandescent Lamps.* To remove a defective neon or incandescent lamp, unscrew it from its socket.

### 38. Removal and Replacement of Electric Heater

(fig. 17)

#### *a. Removal.*

- (1) Operate the HEATER-OFF-FAN switch to OFF.
- (2) Remove the power cord connector plug from the HEATER receptacle (fig. 11 or 14).
- (3) Loosen the four turnlock fasteners that secure the heater to the mounting base.
- (4) Remove the mounting base knob.
- (6) Slide the heater to the right until it clears the flange on the mounting base and lift out the heater.

#### *b. Replacement.*

- (1) Slide the heater onto the mounting base so that it engages the flanges.
- (2) Tighten the four turnlock fasteners.
- (3) Replace and tighten the mounting base knob.

### 39. Removal and Replacement of Exhaust Blower Cover

#### *a. Removal.*

- (1) Operate the associated BLOWER switch to OFF (fig. 16).
- (2) Remove the power cord connector plug from its receptacle.
- (3) Remove the screws that secure the cover to the front wall and lift off the cover.

*b. Replacement.* Replace the cover by following the procedures in (1) through (3) above in the reversed order.

### 40. Removal and Replacement of LS-147(\*)/FI

#### *a. Removal.*

- (1) Remove the power cord connector plug from the INTERCOM power duct receptacle (fig. 16).
- (2) Release the mounting clamps by loosening the captive wingnuts.
- (3) Disconnect the telephone connecting cord from the binding posts on the rear of the LS-147(\*)/FI.
- (4) Remove the LS-147(\*)/FI from its mounting position.

*b. Replacement.* Replace the LS-147(\*)/FI by following the procedures in a(1) through (4) above in the reversed order.

### 41. Removal and Replacement of SB-22(\*)/PT

#### *a. Removal.*

- (1) Remove the wingnuts that secure the SB-22(\*)/PT retaining bar (fig. 13) and raise the retaining bar.
- (2) Slide the SB-22(\*)/PT forward from the rack mounting and expose the rear of the SB-22(\*)/PT.
- (3) Disconnect the wires from the binding posts on the rear of the SB-22(\*)/PT.
- (4) Remove the SB-22(\*)/PT. Remove the batteries from the SB-22(\*)/PT (TM 11-8805-262-12).

*b. Replacement.* Replace the SB-22(\*)/PT by the following appropriate procedures in paragraph 11.

### 42. Removal and Replacement of TA-312/PT (PHONE 4, Mounted)

(fig. 11 and 24)

#### *a. Removal.*

- (1) Remove the telephone connecting cord leads from the LINE binding posts of the TA-312/PT.
- (2) Remove the flathead screw on the side of the mounting bracket.
- (3) Lift the TA-312/PT out of the mounting bracket and remove the holding plate from the buzzer recess on the side of the TA-312/PT.
- (4) Remove the batteries from the TA-312/PT (TM 11-2155).

*b. Replacement.* Replace the TA-312/PT by following the appropriate procedures in paragraph 12.

### 43. Removal and Replacement of TT-4(\*)/TG

#### a. Removal.

- (1) Operate the MOTOR switch on the TT-4(\*)/TG to OFF.
- (2) Disconnect the power cord connector plug from the TT-4A/TG receptacle (fig. 13) and the teletypewriter connecting cords from the teletypewriter patch panel.
- (3) Remove the web strap across the TT-4(\*)/TG. Remove the wingnut beneath the tabletop or mounting shelf and remove the holddown bars.
- (4) Lift the TT-4(\*)/TG from its position.

b. *Replacement.* Replace the unit by following the appropriate procedure in paragraph 15.

### 44. Removal and Replacement of TT-76(\*)/GGC

#### a. Removal.

- (1) Operate the MOTOR and POWER switches on the TT-76(\*)/GGC to OFF.
- (2) Disconnect the power cord connector plug from the TT-76/GGC receptacle (fig. 13). Disconnect the teletype-

writer connecting cords from the teletypewriter patch panel (fig. 20).

- (3) Remove the wingnuts beneath the tabletop. Remove the TT-76(\*)/GGC from its position.

b. *Replacement.* Replace the unit by following the appropriate procedures in paragraph 14.

### 45. Removal and Replacement of TH-5/TG

#### a. Removal.

- (1) Operate the associated ON-OFF switch on the TH-5/TG subdistribution panel (fig. 12 and 21) to OFF.
- (2) Disconnect the power cord connector from the TH-5/TG subdistribution panel receptacle. Remove any patch cords connected to the SEND and REC jacks.
- (3) Tag and remove the wires connected to the 2W binding posts.
- (4) Lift up the rack designation plate. Pull the chassis forward and lift it from its rack mounting.

b. *Replacement.* Replace the unit by following the appropriate procedures in paragraph 13.

## Section II. ORGANIZATIONAL, FIELD, AND DEPOT MAINTENANCE

*Note.* The maintenance allocation chart (appx II) indicates the maintenance functions and tools authorized for each maintenance echelon.

### 46. Troubleshooting Information

a. Procedures for localizing troubles within the AN/MS-32 are given in the equipment performance checklist (para 35).

b. Procedures for troubleshooting components, parts, and wiring of the S-184 /MSC-32 are given in paragraph 47.

c. Procedures for troubleshooting the major components of the AN/MS-32 are given in the applicable technical manuals (appx I). Refer to paragraphs 36 through 45 for removal and replacement of components.

### 47. Troubleshooting and Repair Procedures

Isolate defective components, parts, or wiring of the S-184/MS-32 by making appropriate voltage, resistance, or continuity tests with Multimeter AN/URM-105. Refer to figure 41 when isolating trouble in the power circuits and to figure 42 for signal circuits. Repair or replace components, parts, or wiring. Use the chart below for references to repair procedures.

**Warning:** Be extremely careful when performing the troubleshooting procedures; dangerous voltages are present in the equipment.

Part or component	Reference	
	Para	Fig. No.
Door microswitch .....	51b	
Electric heater .....	49	31, 32
Exhaust blower .....	50	33, 34
Fluorescent light fixture .....	52	36
Power distribution panel .....	48	30
Shelter repairs .....	54	
Switches .....	51	
26-pair cable receptacle .....	53	37, 38, 39

#### 48. Power Distribution Panel Repairs (fig. 30)

*a. Preliminary Procedures.* Operate the MAIN circuit breaker switch to OFF (fig. 10) and disconnect the ac power cable at the power and signal entrance box (fig. 8). Remove the screws that secure the power distribution panel cover and remove the cover.

#### *b. Removal and Replacement of Circuit Breaker Switch.*

- (1) Grasp the defective circuit breaker switch and pull it straight out from the panel.
- (2) Insert the replacement circuit breaker switch in place and press it back into the panel.

#### *c. Removal and Replacement of Current Transformer.*

- (1) Remove the screws that hold the meter panel to the power distribution panel.
- (2) Tag and disconnect the current transformer leads from the ammeter.
- (3) Remove the bolts that secure the current transformer inside the panel and remove the current transformer.

*Note.* Count the number of turns of heavy black wire around the current transformer before performing the procedure in (4) below.

- (4) Disconnect the black wire wound around the current transformer from the MAIN circuit breaker switch and

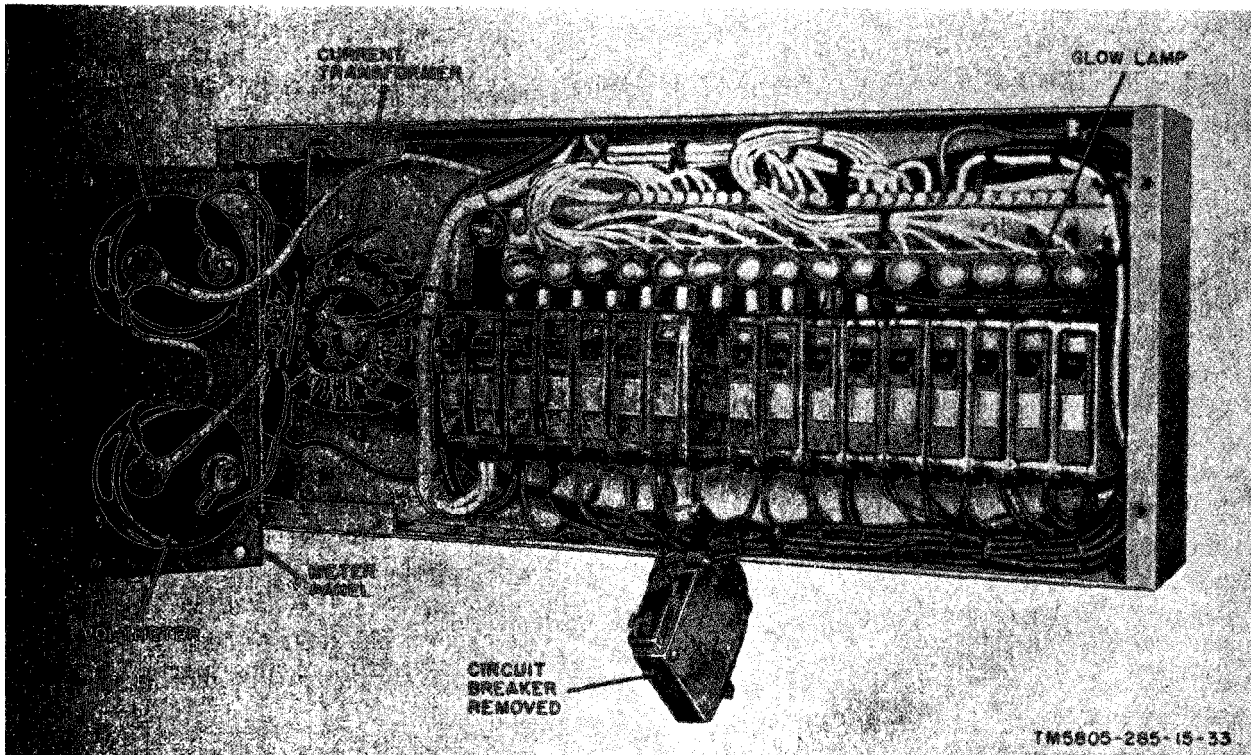

Figure 30. Typical power distribution panel, meter panel, and circuit breaker switch removed.

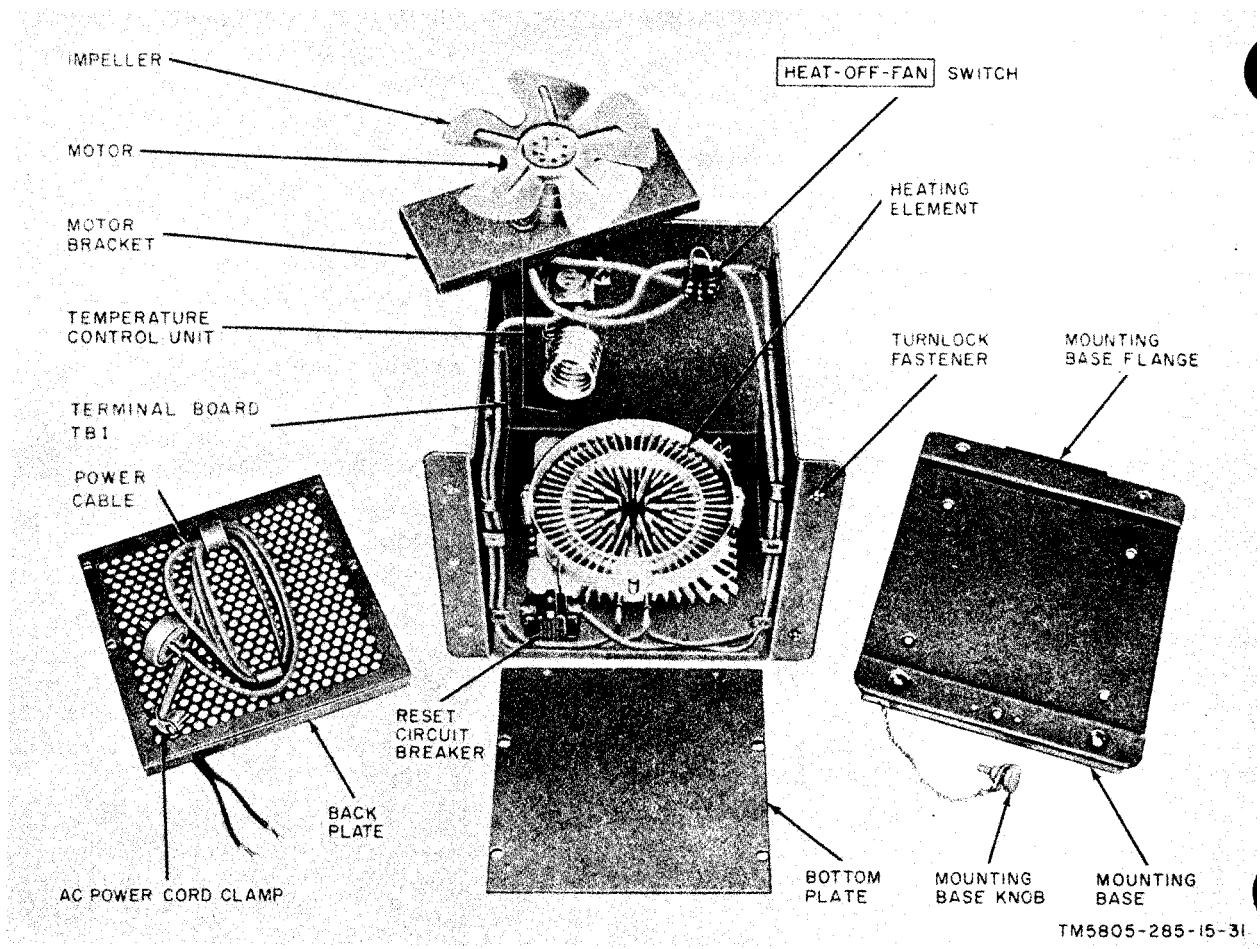

Figure 31. Electric heater, partially disassembled, rear view.

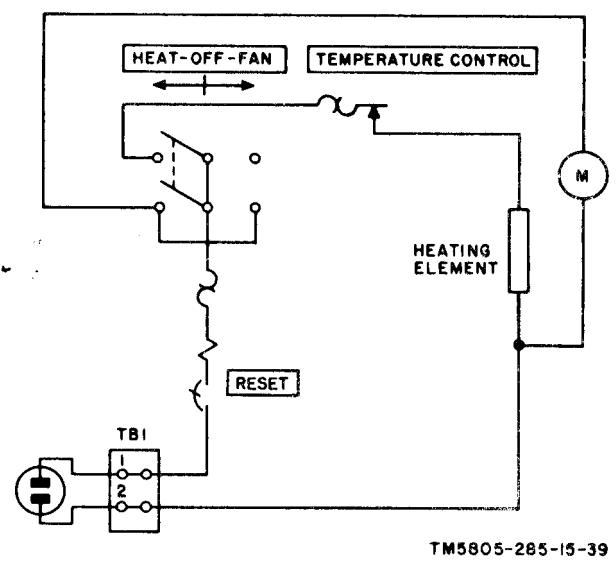

Figure 32. Electric heater, schematic diagram.

carefully unwind the wire from the current transformer.

- (5) Wind the black wire around the replacement transformer.

**Caution:** Be sure that the number of turns is the same as on the original transformer. Reconnect the black wire to the MAIN circuit breaker switch (fig. 41).

- (6) Position the replacement transformer inside the panel and replace and tighten the bolts.
- (7) Connect the transformer leads to the ammeter.
- (8) Replace the meter panel and tighten the screws.

d. Removal and Replacement of Meter.

- (1) Remove the four screws that hold the

meter panel to the power distribution panel.

- (2) Tag and disconnect the leads from the meter terminals.
- (3) Remove the screws that hold the meter to the meter panel and lift out the meter.
- (4) Connect the leads to the replacement meter.
- (5) Position the meter in the panel and tighten the screws.
- (6) Replace the meter panel and tighten the screws.

## 49. Electric Heater Repairs

(fig. 31 and 32)

*a. Preliminary Procedures.* Before performing the repair procedures in *b* through *g* below, remove the heater from its mounting base (para 38a) and remove the backplate and bottom plate as follows:

- (1) Remove the screws that secure the bottom plate to the heater.
- (2) Remove the screws that secure the backplate to the bottom plate, and remove the bottom plate.
- (3) Loosen the power cord clamp on the backplate.
- (4) Remove the screws that secure the backplate to the heater and remove the backplate.

*b. Removal and Replacement of Power Cord.*

- (1) Loosen the screws and remove the the power cord leads from terminal board TB1 (fig. 32).
- (2) Pull the power cord out of the clamp in the backplate (fig. 31).
- (3) Insert a new power cord through the clamp in the backplate.
- (4) Connect the leads to terminal board TB1.

*c. Removal and Replacement of Temperature Control Unit.*

- (1) Loosen the screws and remove the wires from the temperature control unit.
- (2) Remove the screws that secure the unit to the cabinet and remove the unit.
- (3) Insert the TEMPERATURE CON-

TROL switch on the replacement unit through the slot in the cabinet. Replace and tighten the screws.

- (4) Connect the wires to the temperature control unit.

*d. Removal and Replacement of HEAT-OFF-FAN Switch.*

- (1) Tag and unsolder the tires and strap connected to the switch.
- (2) Remove the ringnut that secures the switch through the top of cabinet and remove the switch.
- (3) Solder the strap and the wires to the replacement switch.
- (4) Position the switch and tighten the ringnut.

*e. Removal and Replacement of Reset Circuit Breaker.*

- (1) Loosen the screws and remove the insulated wires to the circuit breaker. Loosen the bolt and remove the bare copper wire from the heating element.
- (2) Remove the mounting screws that fasten the circuit breaker to the cabinet and remove the circuit breaker.
- (3) Connect the insulated wires ((1) above) to the replacement circuit breaker. Connect the bare copper wire to the heating element.

**Caution: Do not alter the shape or length of the bare copper wire.**

- (4) **Position the circuit breaker and replace and tighten the mounting screws.**

*f. Removal and Replacement of Motor and Impeller.*

- (1) Remove the screws that secure the motor bracket to the cabinet and lift out the motor bracket.
- (2) Tag and disconnect the motor leads at the HEAT-OFF-FAN switch and at the taped splice in the heating element cable.
- (3) Remove the screws that secure the motor to the bracket.
- (4) Unscrew the metal fastener that secures the impeller to the motor shaft and remove the impeller.
- (5) Position and secure a replacement



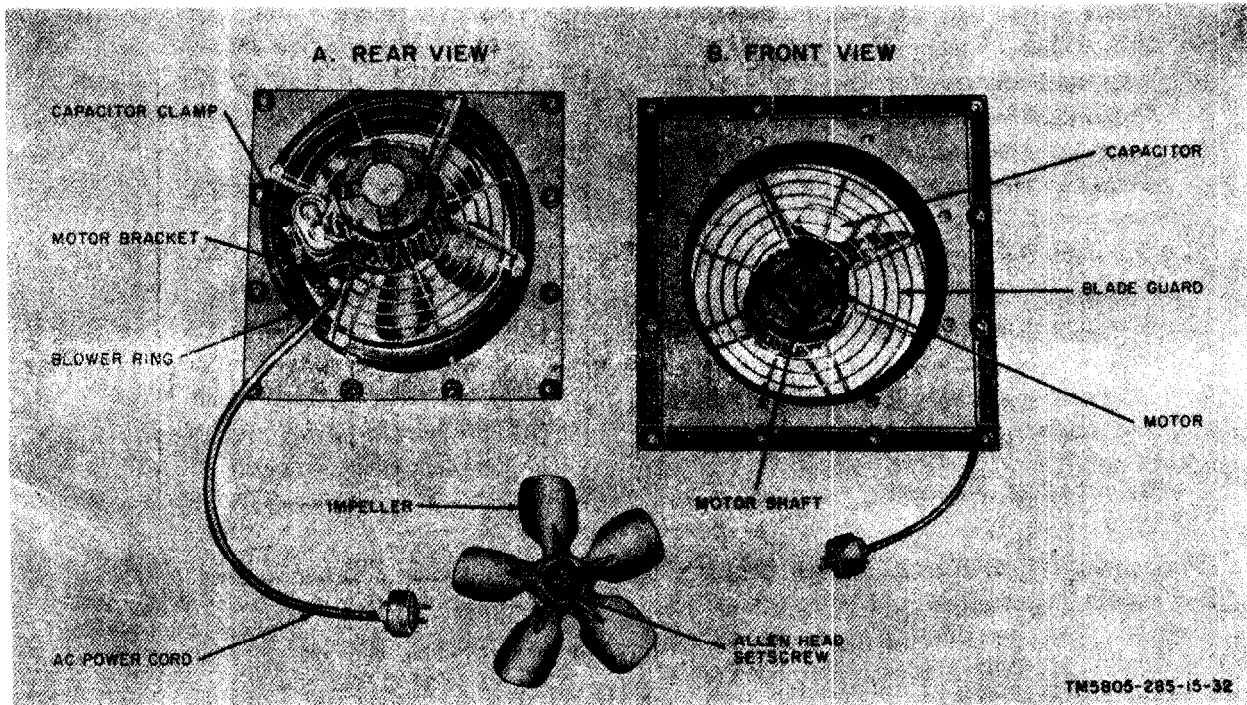

Figure 33. Exhaust blower, front and rear view.

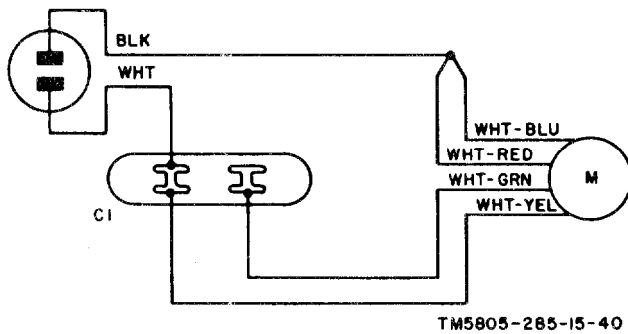

Figure 34. Exhaust blower, schematic-wiring diagram.

motor in the bracket. Slide the impeller onto the motor shaft and tighten the fastener.

- (6) Replace the motor bracket in the cabinet and connect the motor leads ((2) above).

*g. Removal and Replacement of Heating Element.*

- (1) Remove the screws that secure the motor bracket to the cabinet and remove the motor bracket.
- (2) Loosen the bolt that secures the bare

copper wire from the circuit breaker to the heating element and remove the wire.

**Caution:** Be extremely careful when removing this lead. Do not alter the length or shape of the bare copper wire.

- (3) Tag and remove the wire connections from the plug-in terminals on the heating element.
- (4) Remove the screws that secure the heating element to the cabinet. Be careful not to bend the louvers on the front of the cabinet during the removal procedure.
- (5) Position the replacement element and replace and tighten the screws.
- (6) Connect the wires to the plug-in terminals of the heating element.
- (7) Replace the bare wire connected from the circuit breaker ((2) above).
- (8) Position the motor bracket in the cabinet and replace and tighten the screws.

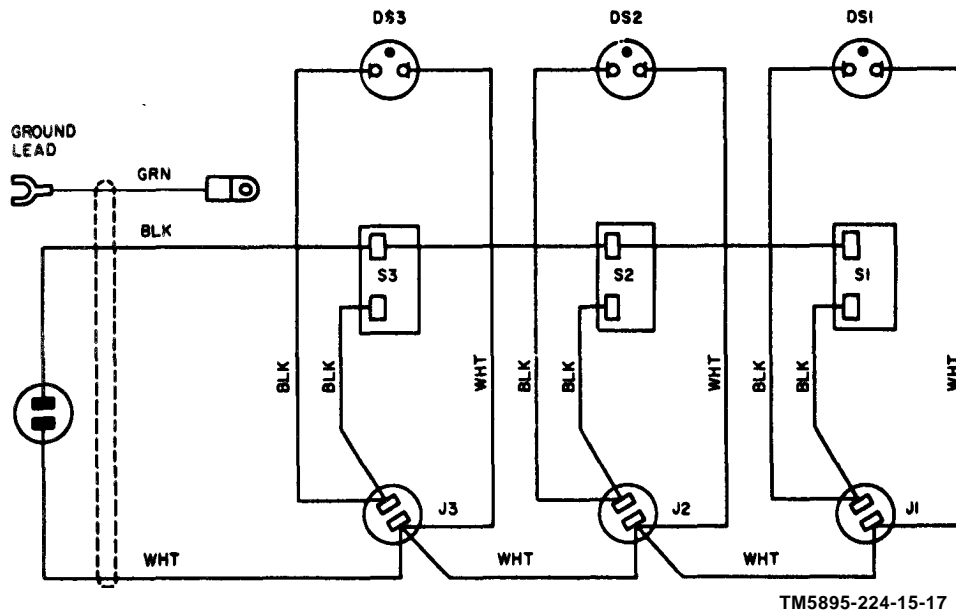

TM5895-224-15-17

Figure 35. TH-5/TG subdistribution panel wiring diagram.

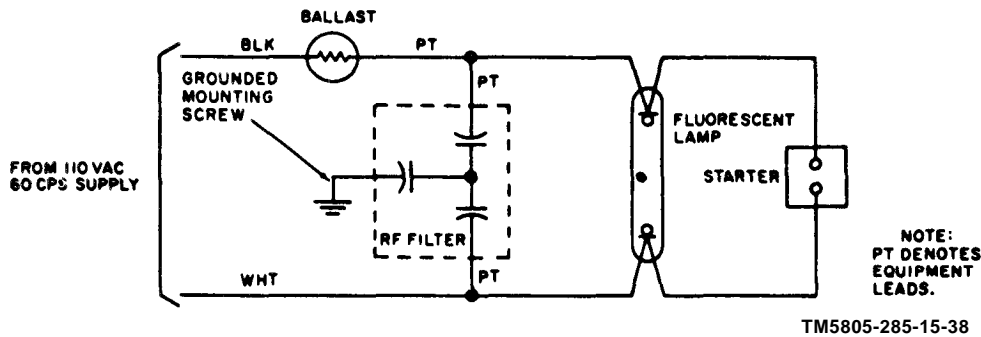

TM5805-285-15-38

Figure 36. Fluorescent light fixture, schematic-wiring diagram.

## 50. Exhaust Blower Repairs

(fig. 33 and 34)

a. *Preliminary Procedures.* Before performing the repair procedures in *b* through *d* below, remove the exhaust blower cover (para 39a) and remove the power cord connector plug from its receptacle (fig. 16).

b. *Removal and Replacement of Capacitor.*

- (1) Loosen the capacitor clamp screw.
- (2) Remove the power cord clamp from the motor bracket.

Slide the capacitor out of the clamp. Tag and disconnect the motor leads and the power cord from the capacitor terminals.

- (5) Connect the motor leads and the power cord to the replacement capacitor (fig. 34).
  - (6) Slide the capacitor into the clamp and tighten the screw.
  - (7) Replace the power cord clamp.
- c. *Removal and Replacement of Power Cord.*
- (1) Remove the capacitor from the clamp (b(2) through (4) above),
  - (2) Tag and disconnect the power cord leads from the capacitor and motor leads.
  - (3) Connect the new power cord to the capacitor and motor leads (fig. 34).
  - (4) Slide the capacitor into the clamp and tighten the screw.

- (5) Replace the power cord clamp.

*d. Removal and Replacement of Motor and Impeller.*

- (1) Remove the screws from the bottom edge of the plate that holds the exhaust blower to the front wall.
- (2) Lift the exhaust blower away from the wall.
- (9) Remove the bolts that secure the blade guard and motor brackets to the blower ring.
- (4) Tag and disconnect the motor leads from the capacitor and power cord.
- (5) Remove the power cord clamp.
- (6) Remove the screws that secure the motor mounting bracket to the motor.
- (7) Loosen the Allen-head setscrews that secure the impeller to the motor shaft and remove the impeller.
- (8) Slide the impeller (setscrews toward the motor) onto the shaft of the new motor and tighten the setscrews.
- (9) Secure the motor bracket to the new motor.
- (10) Connect the motor leads to the capacitor and power cord (fig. 34).
- (11) Replace the power cord clamp.
- (12) Position the motor bracket and blade guard on the blower ring.
- (13) Replace and tighten the bolts that secure the motor bracket and blade guard to the blower.
- (14) Replace the exhaust blower by reversing the procedures given in (1) and (2) above.
- (15) Replace the exhaust blower cover (para 39b).

## 51. Removal and Replacement of Switches

*a. Power Duct Switches.*

- (1) Operate the associated circuit breaker switch to OFF (fig. 41).
- (2) Remove the screws from the brackets at each end of the switch. Remove the two brackets and the switchplate.
- (8) Remove the switch mounting screws and the switch.
- (4) Tag and remove the wires from the switch and connect them to the replacement switch (fig. 41).

- (5) Replace the switch by reversing the procedures given in (1) through (4) above.

*b. Door Microswitch.*

- (1) Disconnect ac power from the AN/ MSC-32.
- (2) Carefully pry off the Tower duct cover between the POWER INDICATOR NEON LAMP and LIGHT 1 switch (fig. 14).
- (3) Tag and remove the wires from the NO and C terminals of the switch (fig. 41).
- (4) Unscrew the ringnut from the door side of the switch, and remove the switch.
- (5) Replace the switch by reversing the procedures given in (1) through (4) above.

*c. TH-5/TG Subdistribution Panel Switches (fig. 21).*

- (1) Operate circuit breaker switch No. 5 to OFF.
- (2) Remove the screws that secure the panel to the case.
- (3) Remove the ringnut that secures the switch to the panel and remove the switch from the panel.
- (4) Tag and disconnect the wires from the switch (fig. 35).
- (5) Replace the switch by reversing the procedures given in (1) through (4) above.

## 52. Removal and Replacement of Fluorescent Light Fixture Components

**Note.** The fluorescent light fixtures are fabricated as part of the power duct. The radiofrequency filters are sealed units; they are not repairable and are replaced as a complete unit.

*a.* Operate the associated LIGHT switch to OFF; remove the light shield and the fluorescent lamp (para 37a(1) and (2)).

*b.* Carefully pry off the associated power duct cover.

*c.* Tag and disconnect the wires from the defective component (fig. 36) and remove the defective component from the power duct.

*d.* Secure the replacement in the power duct.

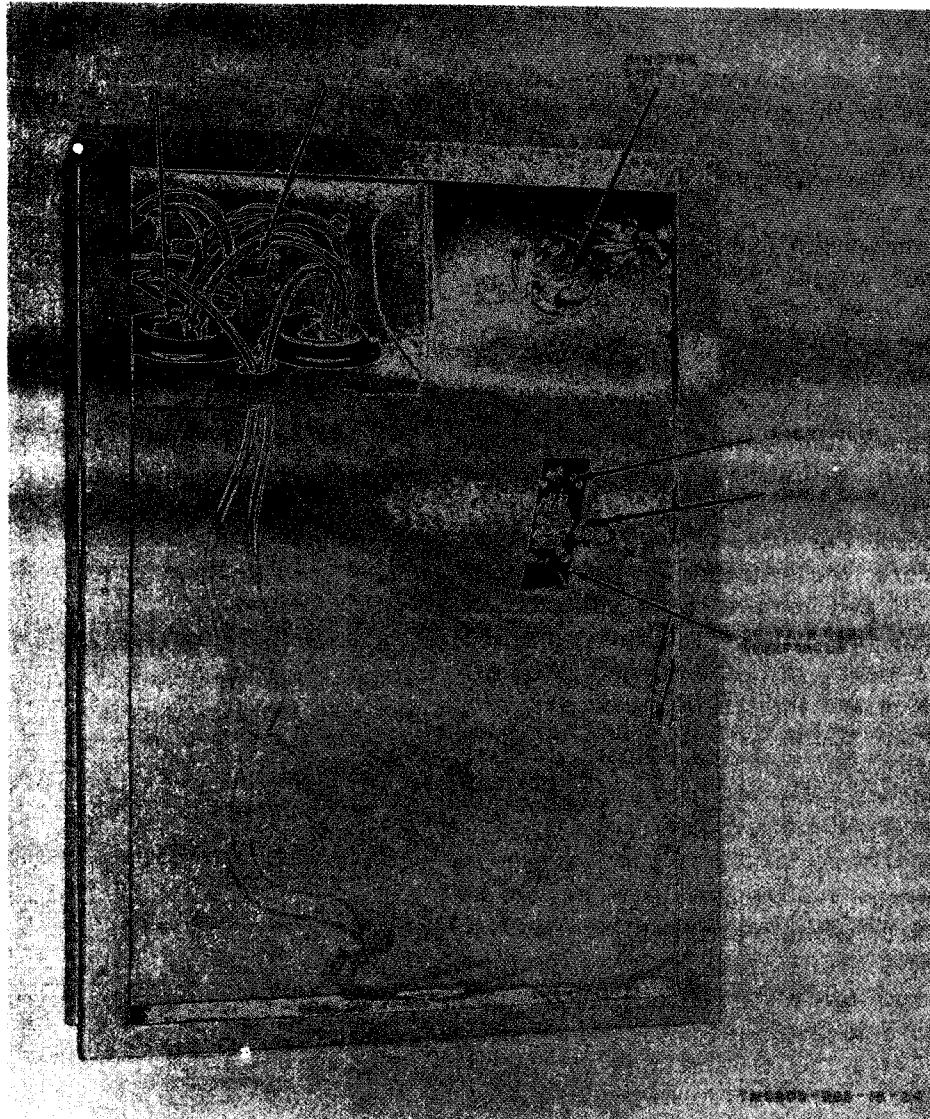

Figure 37. Power and signal entrance box, rear view.

e. Connect the wires to the replacement component.

f. Replace the cover on the power duct.

g. Replace the fluorescent lamp and light shield (para 37a(4) through (6)).

### 53. Removal and Replacement of 26-Pair Cable Receptacle

#### a. Removal.

(1) Remove the screws that fasten the cover to the power entrance panel (fig. 14) and remove the cover.

(2) Remove the mounting screws that secure the insert clips (fig. 37 and 38).

(3) Unfasten the cable clip nearest the 26-pair cable receptacle mounting.

(4) At the power and signal entrance panel, remove the 26-pair cable receptacle cover.

(5) Lift the receptacle insert (fig. 38) from the front of the 26-pair cable receptacle housing.

(6) Tag and unsolder the wires from the receptacle insert.

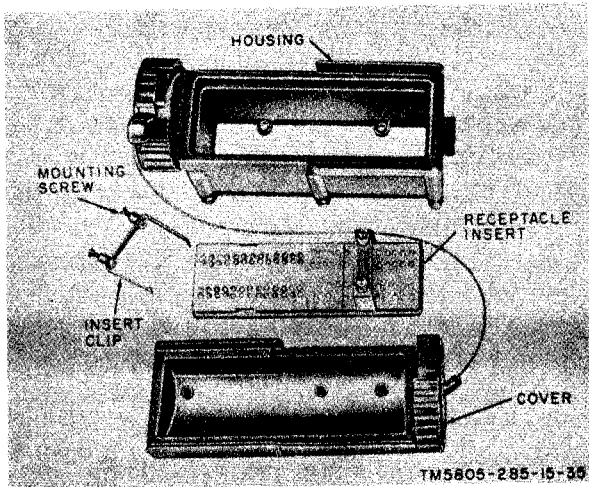

Figure 38. Cable receptacle, 26-pair, partially disassembled.

**b. Replacement.**

- (1) Connect the cable wires to the replacement receptacle insert (fig. 39).

**Caution:** Be extremely careful when connecting and soldering wires. Excessive heat or pressure will damage the insert.

- (2) Carefully place the insert in the 26-pair cable receptacle housing, (fig. 38).

**Caution:** Be careful not to damage the wires when replacing screws or when taking up slack in the 26-pair cable.

- (3) Replace the insert clip and tighten the mounting screws (a(2) above).
- (4) Fasten the cable clip (a(3) above).
- (5) Replace the power and signal entrance box panel cover and the 26-pair receptacle cover.

**54. Shelter Maintenance**

a. The maintenance or repair of the S-184/MSC-32 racks, frames, brackets, and assorted hardware is accomplished by removing and replacing screws or bolts. When any exterior component of the shelter is replaced, be sure the gasket is adequately sealed to the shelter to prevent leakage. The responsibilities for shelter maintenance are listed in the maintenance allocation chart (appx II).

b. The exterior skin of the shelter is susceptible to puncturing or gouging during the loading and transportation procedures. Use Patch Kit, Shelter, Electrical Equipment (Federal stock No. 5410-783-6250) to repair the roof or sides of the shelter as described in the instructions with the patch kit and given below.

- (1) Use emery cloth, sandpaper, a knife, or scraper and remove all paint or foreign matter within a 3-inch radius around the hole to be patched. Do not touch the cleaned area with hands or dirty rags.
- (2) If the insulation has been gouged out, fill the hole with clean noncombustible material, if possible. Do not use the glass cloth for this purpose.
- (3) Cut out a piece of glass cloth that will extend 2 inches beyond the edges of the hole to be repaired.

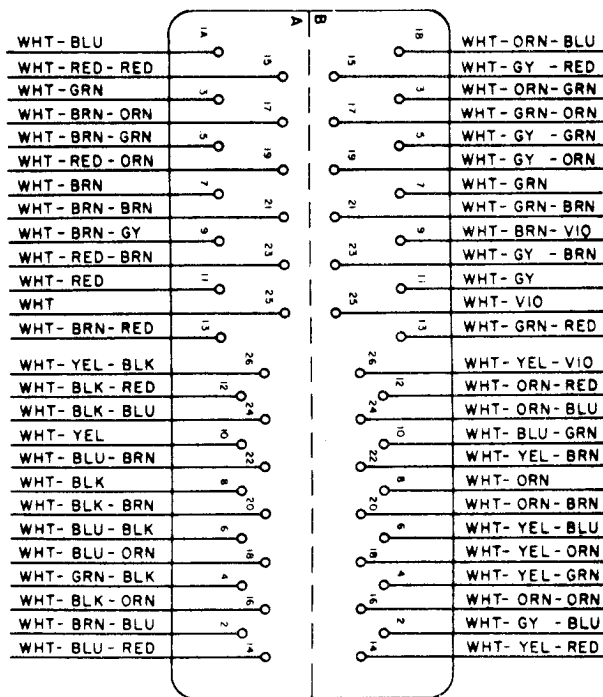

**NOTES**

1. CONNECTOR AS SEEN FROM WIRING SIDE.
2. WIRES CONNECTED TO TERMINALS 1A AND 1B, 2A AND 2B ETC, ARE PAIRED WIRES.
3. BLUE AND RED SPARE WIRES (NOT SHOWN) ARE TURNED BACK AND SEWN INTO FORM.

TM5805-285-15-41

Figure 39. Cable receptacle insert, 26-pair, wiring diagram.

**Warning: Resin No. 797 and curing agent No. 237 are harmful to the skin. Wash thoroughly with water any area of the body that may have come in contact with the liquid resin or curing agent.**

- (4) Pour 3 ounces of resin No. 797 for each square foot of surface area to be covered into the mixing cup provided. Shake the can thoroughly before pouring out the resin. Temperature and climate will determine the quantity of curing agent and cold weather promoter to be added to the resin. Use the eye dropper and prepare the mixture as follows:
  - (a) For temperatures above 55°F, fill the eye dropper to the red line with curing agent No. 237. Add the curing agent to the resin and mix thoroughly.
  - (b) For temperatures between 20° and 55°F, fill the eye dropper to the red line with curing agent No. 237. Fill the eye dropper to the halfway mark with cold weather promoter No. 347. Add the cold weather promoter to the combined curing agent and resin and mix thoroughly.
  - (c) For temperatures below 20°F, fill the eyedropper to the red line with curing agent No. 237; add the curing agent to the resin and mix thoroughly. Fill the eye dropper to the red line with cold weather promoter No. 347. Add the cold

weather promoter to the combined curing agent and resin and mix thoroughly.

- (5) Use the spatula (or the brush in hard-to-reach areas or when the temperature is above 55°F) and spread a liberal coating of the prepared mixture over the surface to be patched. Place the glass cloth ((3) above) over the coating and press it lightly with the applicator. Spread a second liberal coating of the mixture over the glass cloth; work from the center of the patch towards the edges.
- (6) Examine the patch to see that the edges are flat and firmly embedded in the mixture. Be sure the patch is completely covered by the mixture. Prepare and apply an additional mixture, if necessary.

***Note.*** To accelerate curing during cold weather, heat the patch with warm, dry air or radiant heat. Do not use an open flame.

- (7) Depending on the temperature and drying conditions, the patched surface may be sanded and painted within 4 to 24 hours after application of the patch. After the mixture in the cup and on the spatula has hardened, flex the cup and the spatula to crack the mixture. Clean the cup and spatula and store them for future use. Discard the used brush; recap and store the containers.

***Caution:*** Storage life of the patch kit materials is severely limited by heat; recap the containers tightly and store them in a cool, dry place.

## CHAPTER 5

### THEORY

---

#### 55. Signal Circuits

(fig. 42)

*a. SB-22(\*)/PT Circuits.* The external circuits to the SB-22(\*)/PT connect to the SIGNAL 1 26-pair cable receptacle J1 in the power and signal entrance box (pairs 1 through 12) and the binding posts pairs in the binding post signal entrance box (pairs 1 through 12). Inside the shelter, the circuits connect to the SB-22(\*)/PT through signal duct wiring, the SB-22/PT cable stub, and the LINES SB-22/PT jacks No. 1 through 12.

*b. TH-5/TG Circuit.* The external circuits to the TH-5/TG connect to the SIGNAL 1 26-pair cable receptacle J1 in the power and signal entrance box (pairs 13, 14, and 15) and the binding posts pairs in the binding post signal entrance box (pairs 13, 14, and 15). Inside the shelter, the circuits connect to the TH-5/TG's (No. 1, 2, and 3) through signal duct wiring, and the LINES TH-5/TG (13, 14, and 15) jacks to the TH-5/TG 2W binding posts. The TH-5/TG loop circuits are patched to the teletypewriter circuits (*e* below).

*c. Spare Lines Circuits.* The external circuits to the spare lines connect to the SIGNAL 1 26-pair receptacle J1 in the power and signal entrance box (pairs 16 through 21) and the binding posts pairs in the binding post signal entrance box (pairs 16 through 21). Inside the shelter, the circuits connect to the LINES SPARES jacks No. 16 through 21.

*d. TA-312/PT Circuits.* The external circuits to the TA-312/PT's connect to the PHONE 1 through PHONE 4 binding posts in the power and signal entrance box (pairs 1 through 4) or to the SIGNAL 1 26-pair receptacle J1 in the power and signal entrance box (pairs 22 through 25). Inside the shelter, the circuits connect to the PHONE 1 through

PHONE 4 jacks (J1, J3, J5, and J7). The TA-312/PT's are connected to these jacks.

*e. TT-4(\*)/TG and TT-76(\*)/GGC Circuits.* The send, receive, and transmitter distributor circuits of the TT-4(\*)/TG and the TT-76(\*)/GGC are connected to the associated jacks in the teletypewriter patch panel.

- (1) For teletypewriter transmission, the patch panel TT-4A/TG #1 and TT-4A/TG #2 SEND jacks, and the TT-76/GGC TR and TD jacks are patched to the TH-5/TG SEND jacks (*b* above) or the spare lines jacks (*c* above).
- (2) For teletypewriter reception, the patch panel TT-4A/TG #1, TT-4A/TG #2, and TT-76/GGC REC jacks are patched to the TH-5/TG REC jacks (*b* above) or the spare lines jacks (*c* above).

#### 56. Ac Power Circuits

(fig. 41)

**Note.** The function of each switch and indicator in the S-184/MSC-32 is covered in paragraph 25.

*a. Ac Power Distribution.*

- (1) Ac power is applied to the AN/MSC-32 through IN POWER 115V AC receptacle J1 in the power and signal entrance box. Parallel-connected OUT POWER 115V AC receptacle J2 is provided so that another area assemblage may be connected to the AN/MSC-32 power source.
- (2) Ac power from receptacle J1 is applied through the power duct wiring to MAIN circuit breaker switch CB7 on the power distribution panel. Circuit breaker switches CB1 through CB6 (parallel-connected) are connected in series with CB7. Wiring to

the equipment and convenience receptacles is distributed through the power duct from circuit breaker switches CB1 through CB6. Lamp DS7 is connected across the ac input lines to CB7, and lights when power is applied to the AN/MSC-32. Lamps DS1 through DS6 are connected across the circuits controlled by CB1 through CB6, respectively, and light individually as each circuit breaker switch is operated to ON.

*b. Grounding.* The AN/MSC-32 is grounded to reduce electrical shock hazards. Ground

terminals for the AN/MSC-32 components are provided inside the S-184/MSC-32.

*c. Voltmeter and Ammeter.*

- (1) Voltmeter M1 is connected across the ac input circuit after MAIN circuit breaker switch CB7. It indicates the voltage applied from the power source to the AN/MSC-32.
- (2) Ammeter M2 is connected to the ac input circuit through current transformer T1. It indicates the total current being drawn by the operating components of the AN/MSC-32.



## CHAPTER 6

# SHIPMENT AND LIMITED STORAGE AND DEMOLITION TO PREVENT ENEMY USE

### Section I. SHIPMENT AND LIMITED STORAGE

#### 57. Disassembly of Equipment

Perform the following procedures when the AN/MSC-32 is moved to a different location or placed in storage.

*a.* Operate all ac power switches and circuit breaker switches to their OFF positions except the LIGHT 1 and LIGHT 2 switches, circuit breaker switch 1 LIGHTS, and the MAIN circuit breaker switch.

*b.* Remove the batteries from the TA-312/PT, the SB-22 ( \* ) /PT, and the hand lantern for prolonged storage or long-distance shipment.

*c.* Secure all components in their cases, mountings, or holders.

*d.* Place all miscellaneous items in the storage drawers and cabinets, and secure the drawers and cabinets for transit.

*e.* Disconnect the field wires from the PHONE and INTERCOM binding posts in the power and signal entrance box (fig. 8) and from the binding posts in the binding post signal entrance box (fig. 9).

*f.* Disconnect the 26-pair cable at the power and signal entrance box and replace the covers on the receptacles and connectors.

*g.* Operate the LIGHT 1 and LIGHT 2 switches, circuit breaker switch 1 LIGHTS, and the MAIN circuit breaker switch to OFF.

*h.* If power was obtained from an adjacent shelter, disconnect the AN/MSC-32 power cable from the OUT POWER 115V AC receptacle at the adjacent shelter. Replace the receptacle and connector cover.

*i.* If power was obtained from a commercial source, proceed as follows:

- (1) Turn off or disconnect the power.

- (2) Disconnect the power cable connector from the power cable stub connector. Replace both connector covers.

- (3) Disconnect the power cable stub from the commercial source and store it in a storage cabinet.

*j.* Disconnect the power cable from the IN POWER 115V AC receptacle in the power and signal entrance box and replace the covers on the receptacle and connector.

*k.* Disconnect the ground strap from the GROUND TERMINAL in the power and signal entrance box. Close and secure the cover on the power and signal entrance box.

*l.* Store the round strap in a storage cabinet.

*m.* Close and secure the covers on the exhaust blower vents and on the air filter.

*n.* Remove the ground rod and store it in the shelter (fig. 14).

*o.* Wind the power cable and the CX-4566/G on the cable reels and secure the reels to the floor of the shelter (fig. 15).

*p.* Recheck the area for any loose items. Be sure all items are properly stored in the shelter.

*q.* Clean the shelter thoroughly and check to see that the drain plug (fig. 15) is firmly in place.

*r.* Close and lock the shelter door.

#### 58. Transportation

The AN/MSC-32 can be transported by truck or by helicopter. Refer to paragraph 19 for lifting, loading, and unloading instructions.

**Caution:** When transporting the AN/MSC-32 by air, the outside vent covers of the shelter must be opened to equalize the pressure inside and outside the shelter.

## Section II. DEMOLITION OF MATERIEL TO PREVENT ENEMY USE

### 59. Authority for Demolition

Demolition of the equipment will be accomplished only upon the order of the commander. The destruction procedures outlined in paragraph 60 will be used to prevent further use of the equipment.

### 60. Methods of Destruction

Use any or all of the following methods to destroy the equipment:

*a. Smash.* Smash the controls, tubes, coils, relays, switches, capacitors, transformers, and meters; use sledges, axes, handaxes, pickaxes, hammer, or crowbars.

*b. Cut.* Cut all cables and cords and slash

the wiring on the components; use axes, handaxes, or machetes,

*c. Burn.* Burn cords and technical manuals; use gasoline, kerosene, oil, flamethrowers or incendiary grenades.

*d. Bend.* Bend panels and cabinets.

**Warning: Be extremely careful with explosives and incendiary devices. Use these items only when the need is urgent.**

*e. Explode.* If explosives are necessary, use firearms, grenades, or TNT,

*f. Dispose.* Bury or scatter the destroyed parts in slit trenches or foxholes, or throw them into streams.

# APPENDIX I

## REFERENCES

---

AR 320-5	Dictionary of United States Army Terms	TM 11-2225	Teletypewriter Sets AN/GGC-3 and AN/GGC-3A and Teletypewriter Reperforator - Transmitters TT-76/GGC, TT-76A/GGC, and TT-76B/GGC
AR 320-50	Authorized Abbreviations and Brevity Codes		
AR 700-38	Unsatisfactory Equipment Report (Reports Control Symbol CSGLD-247(R2))		
DA Pam 108-1	Index of Army Motion Pictures, Film Strips, Slides and Phono Recording's	TM 11-5805-201-12P	Operator and Organizational Maintenance Repair Parts and Special Tools List and Maintenance Allocation Chart: Telephone Set TA-312/PT
DA Pam 310-4	Military Publications: Index of Technical Manuals, Technical Bulletins, Supply Bulletins, Lubrication Orders, and Modification Work orders	TM 11-5805-201-35P	Field and Depot Maintenance Repair Parts and Special Tools List : Telephone Set TA-312/PT
DA Pam 310-21	Military Publications: Index of Supply Manuals; Signal Corps	TM 11-5805-246-10	Operator's Manual, Terminal, Telegraph TH-5/TG
FM 21-5	Military Training	TM 11-5805-246-12P	Operator's and Organizational Maintenance Repair Parts and Special Tools List and Maintenance Allocation Chart for Terminal, Telegraph TH-5/TG
FM 21-6	Techniques of Military Instruction		
FM 21-30	Military Symbols		
SB 11-100-156	Serviceability Standards for Telephone Set TA-312/PT		
TM 11-2138	Terminal Box TA-125/GT; Telephone Repeating Coil Assembly TA-145/GT; Maintenance Kit MX-842/GT; and Switchboard Signal TA-123/GT	TM 11-5805-246-20	Organizational Maintenance Manual, Terminal Telegraph TH-5/TG
TM 11-2156	Telephone Set TA-312-PT	TM 11-5805-246-35P	Field and Depot Maintenance Repair Parts and Special Tools List: Termi-

	nal, Telegraph TH-5/TG		Switchboard, Telephone, Manual SB-22/PT
TM 11-5805-257-12P	Operator's and Organizational Maintenance Repair Parts and Special Tools List and Maintenance Allocation Chart for Generators, Ringing, Hand G-42/PT and G-42A/PT	TM 11-5815-206-12	Operation and Organizational Maintenance: Teletypewriter Set AN/PGC-1 and Teletypewriter TT-4A/TG and TG-4B/TG
TM 11-5805-257-35P	Field and Depot Maintenance Repair Parts and Special Tools List for Generator, Ringing, Hand G-42/PT and G-42A/PT	TM 11-5815-206-12P	Operator's and Organizational Maintenance Repair Parts and Special Tools List: Teletypewriter Set AN/PGC-1 Including Teletypewriters TT-4A/TG and TT-4B/TG
TM 11-5805-262-10P	Operator's Maintenance Repair Parts and Special Tools List for Switchboard, Telephone, Manual SB-22/PT	TM 11-5815-206-35	Field and Depot Maintenance: Teletypewriter Set AN/PGC-1 and Teletypewriters TT-4A/TG and TT-4B/TG
11-5805-262-12	Operator's and Organizational Maintenance Manual, Switchboards, Telephone, Manual SB-22/PT and SB-22A/PT	TM 11-5815-206-35P	Field and Depot Maintenance Repair Parts and Special Tools List: Teletypewriter Set AN/PGC-1 Including Teletypewriters TT-4A/TG and TT-4B/TG
TM 11-5805-262-20P	Organizational Maintenance Repair Parts and Special Tools List and Maintenance Allocation Chart for Switchboard, Telephone, Manual SB-22/PT	TM 11-5830-221-12	Operator's and Organizational Maintenance Manual: Intercommunication Station LS-147B/FI
TM 11-5805-262-35	Field and Depot Maintenance Manual, Switchboards, Telephone, Manual SB-22/PT and SB-22A/PT	TM 11-5830-221-12P	Operator's and Organizational Maintenance Repair Parts and Special Tools Lists: Intercommunication Station LS-147A/FI and LS-147B/FI
TM 11-5805-262-35P	Field and Depot Maintenance Repair Parts and Special Tools List for		

TM 11-5830-221-86	Field and Depot Maintenance Manual: Intercommunication Station LS-147B/FI	Handset-Headset H-81/U and H-81A/U
TM 11-5830-221-36P	Field and Depot Maintenance Repair Parts and Special Tools List: Intercommunication Station LS-147A/FI and LS-147B/FI	TM 11-6626-274-10P Operator's Maintenance Repair Parts and Special Tools List for Test Sets, Electron Tube TV-7/U, TV-7A/U, TV-7B/U, and TV-7D/U
TM 11-5896-228-16	Operator's, Organizational, Field, and Depot Maintenance Manual Operations Center, Communication AN/MSC-31	TM 11-6625-274-12 Operator's and Organizational Maintenance Manual: Test Sets, Electron Tube TV-7/U, TV-7A/U, TV-7B/U, and TV-7D/U
TM 11-5935-204-15P	Operator, Organizational, Field, and Depot Maintenance Repair Parts and Special Tools List and Maintenance Allocation Chart: Connector, Plug, Electrical U-186A/G	TM 11-6625-274-20P Organizational Maintenance Repair Parts and Special Tools List for Test Sets, Electron Tube TV-7/U, TV-7A/U, TV-7B/U, and TV-7D/U
TM 11-5935-205-15P	Operator, Organizational, Field and Depot Maintenance Repair Parts and Special Tools List and Maintenance Allocation Chart: Connector, Receptacle, Electrical U-187/G	TM 11-6625-274-35P Field and Depot Maintenance Repair Parts and Special Tools List for Test Sets, Electron Tube TV-7/U, TV-7A/U, TV-7B/U, and TV-7D/U
TM 11-5965-207-12P	operator's Organizational Maintenance Repair Parts and Special Tools List and Maintenance Allocation Chart for Handset-Headsets H-81/U and H-81A/U	TM 11-5966-224-12P Operator and Organizational Maintenance Repair Parts and Special Tools List and Maintenance Allocation Chart: Handsets H-60/PT and H-165/U
TM 11-5966-207-861	Field and Depot Maintenance Repair Parts and Special Tools List for	TM 11-5965-233-12P Operator and Organizational Maintenance Repair Parts and Special Tools List and Maintenance Allocation Chart: Headset Microphones H-91,

	U and H-91A/U		timer AN/URM-105
TM 11-6625-203-12	Operation and Organizational Maintenance: Multimeter AN/URM-105, including Multimeter ME-77/U	TM 11-6625-203-35	Field and Depot Maintenance: Multimeter AN/URM-105 including Multimeter ME-77/U
TM 11-6625-203-12P	Operator's and Organizational Maintenance Repair Parts and Special Tools List for Mul-	TM 11-6625-203-35P	Field and Depot Maintenance Repair Parts and Special Tools List for Multimeter AN/URM-105

## APPENDIX II

### MAINTENANCE ALLOCATION

---

#### Section I. INTRODUCTION

##### I. General

*a.* This appendix assigns maintenance functions and repair operations to be performed by the lowest appropriate maintenance echelon.

*b.* Columns in the maintenance allocation chart (Section II) are as follows:

- (1) *Parts or component.* This column shows the nomenclature or standard item name. Additional descriptive data are included only where clarification is necessary to identify the part. Components and parts comprising a major end item are listed alphabetically. Assemblies and sub-assemblies are in alphabetical sequence with their components listed alphabetically immediately below the assembly listing.
- (2) *Maintenance function.* This column indicates the various maintenance functions allocated to the echelon capable of performing the operations.
  - (a) *Service.* To clean, to preserve, and to replenish fuel and lubricants.
  - (b) *Adjust.* To regulate periodically to prevent malfunction.
  - (c) *Inspect.* To verify serviceability and to detect incipient electrical or mechanical failure by scrutiny.
  - (d) *Test.* To verify serviceability and to detect incipient electrical or mechanical failure by use of special equipment such as gages, meters, etc.
  - (e) *Replace.* To substitute serviceable assemblies, subassemblies and parts for unserviceable components.
  - (f) *Rebuild.* To restore an item to a standard as near as possible to

original or new condition in appearance, performance, and life expectancy. This is accomplished through the maintenance technique of complete disassembly of the item, inspection of all parts or components, repair or replacement of worn or unserviceable elements using original manufacturing tolerances and/or specifications and subsequent reassembly of the item.

- (g) *Repair.* To restore an item to serviceable condition through correction of a specific failure or unserviceable condition. This function eludes but is not limited to, inspecting, cleaning, preserving, adjusting, replacing, welding, riveting, and straightening.
- (3) *1st, 2d, 3d, 4th, 5th echelon.* The symbol X indicates the echelon responsible for performing that particular maintenance operation, but does not necessarily indicate that repair parts will be stocked at that level. Echelons higher than the echelon marked by X are authorized to perform the indicated operation.
- (4) *Tools required.* This column indicates codes assigned to each individual tool equipment, test equipment, and maintenance equipment referenced. The grouping of codes in this column of the maintenance allocation chart indicates the tool, test, and maintenance equipment required to perform the maintenance function.
- (5) *Remarks.* Entries in this column will be utilized when necessary to clarify any of the data cited in the preceding columns.

c. Columns in the section allocation of tools for maintenance functions (Section II) are as follows :

- (1) *Tools required for maintenance functions.* This column lists tools, test, and maintenance equipment required to perform the maintenance functions.
- (2) *1st, 2d, 3d, 4th, 5th echelon.* A dagger (†) symbol indicates the echelons allocated the facility.
- (3) *Tool Code.* This column lists the tool code assigned.
- (4) *Remarks.* Entries in this column are used to clarify data in the other columns.

## **2. Maintenance by Using Organizations**

When this equipment is used by signal service organizations organic to theater headquarters or communication zones to provide theater communications, those maintenance functions allocated up to an including fourth echelon are authorized to the organization operating this equipment.

## **3. Mounting Hardware**

The basic entries of this maintenance allocation chart do not include mounting hardware such as screws, nuts, bolts, washers, brackets, clamps, etc.



## Section II. MAINTENANCE ALLOCATION CHART

(1) PART OR COMPONENT	(2) MAINTENANCE FUNCTION	(3) 1ST ECH	(4) 2ND ECH	(5) 3RD ECH	(6) 4TH ECH	(7) 5TH ECH	(8) TOOLS REQUIRED	(9) REMARKS
OPERATIONS CENTRAL, AN/MSC-32	service	X	X					Interior Exterior No adjustments Interior and exterior Continuity
	inspect		X				2,3	
	test		X				1	
	rebuild					X		
SHELTER, ELECTRICAL EQUIPMENT S-184/MSC-32	rebuild					X		
BRACKETS AND BRACKET ASSEMBLIES	replace				X			Fabricate
BULLETIN BOARDS	replace				X			Fabricate
CABLE ASSEMBLIES	replace		X				2	
CABLE	replace		X				2	
CONNECTORS	replace		X					See separate MAC for U-195/G connector
CLOCK	replace		X				2	
CONDUIT ASSEMBLIES								
BALLAST, LAMP	replace		X				2	
CAPACITORS	replace		X				2	
CONNECTORS, RECEPTACLE, ELECTRICAL	replace		X				2	
FILTERS, RADIO INTERFERENCE	replace		X				2	
JACKS, TELEPHONE	replace		X				2	
LAMP HOLDERS	replace		X				2	
LAMPS	replace	X						
SHIELDS, ELECTRIC LIGHT	replace		X					
STARTERS LAMP, FLOURESCENT	replace	X						
SWITCHES	replace		X				2	
CORD ASSEMBLIES	replace		X					
CURTAINS BLACKOUT	replace		X					
FANS, VENTILATING								
CABLE, ELECTRICAL	replace		X				2	
CAPACITORS	replace		X				2	
CLAMP, CAPACITOR	replace				X		2	Fabricate
CONNECTORS, PLUG ELECTRICAL	replace		X				2	
GASKETS	replace				X			Fabricate
IMPELLER, FAN	replace		X				2	
HEATER, SPACE ELECTRICAL								
CABLE, ELECTRICAL	replace		X				2	
CONNECTORS	replace		X				2	

(1)	(2)	(3)	(4)	(5)	(6)	(7)	(8)	(9)
PART OR COMPONENT	MAINTENANCE FUNCTION	1ST ECH	2ND ECH	3RD ECH	4TH ECH	5TH ECH	TOOLS REQUIRED	REMARKS
AN/MSC-32 (continued)								
GRID, HEATING ELEMENT	replace		X				2	
IMPELLER, FAN	replace		X				2	
MOTOR, ALTERNATING CURRENT	replace		X				2	
SWITCHES	replace		X				2	
LANTERN, ELECTRIC								
BATTERIES, BA-30	replace	X						
LAMP, INCANDESCENT	replace	X						
LIGHT, EXTENSION								
LAMP, INCANDESCENT	replace	X						
PANEL POWER DISTRIBUTION								
CIRCUIT BREAKERS	replace		X			X	2	
LAMPS, GLOW	replace	X						
LAMP HOLDERS	replace		X				2	
METERS	replace		X				2	
TRANSFORMER	replace		X				2	
PANEL AND SIGNAL POWER ENTRANCE								
CONNECTORS	replace		X				2,3	See separate MAC for U-187/G connector
GASKETS	replace				X			Fabricate
POSTS, BINDING	replace		X				2	
TERMINAL STUD	replace			X				Fabricate
SHELF ASSEMBLIES	replace				X			Fabricate
SHIELTER	rebuild					X		
DOOR ASSEMBLIES								
FILTERS, AIR CONDITIONING	replace		X				2	
FRAME, AIR FILTER	replace				X			Fabricate
GASKETS	replace			X				
GUARD, AIR FILTER	repair				X			Fabricate
HANDLES, DOOR	replace		X				2	
HINGE ASSEMBLIES	replace		X				2	
LATCH, DOOR	replace		X				2	

(1) PART OR COMPONENT	(2) MAINTENANCE FUNCTION	(3) 1ST ECH	(4) 2ND ECH	(5) 3RD ECH	(6) 4TH ECH	(7) 5TH ECH	(8) TOOLS REQUIRED	(9) REMARKS
<b>AM/MSC-32 (continued)</b>								
LOUVER ASSEMBLIES	replace			X			2	
PANELS, DUTCH DOOR	replace				X		2	
EYEBOLT	replace		X				2	
LIFTS, TIE EYE	replace			X			2	
HOLDINGS	replace				X		2	
FLUC, DRAIN	replace		X				2	
SKIDS	replace				X		2	
STEPS, FOLDING	replace		X				2	
TABLE TOP ASSEMBLIES	replace				X			Fabricate
FACE, BOARDS	replace				X			Fabricate
TIE-DOWN ASSEMBLIES	replace				X			Fabricate

### Section III. ALLOCATION OF TOOLS FOR MAINTENANCE FUNCTIONS

(e) TOOLS REQUIRED FOR MAINTENANCE FUNCTIONS	(c) 1ST ECH.	(c) 2ND ECH.	(c) 3RD ECH.	(c) 4TH ECH.	(c) 5TH ECH.	(f) TOOL CODE	(g) REMARKS
AN/MSC-32 (continued)							
MULTIMETER AN/DM-105*		1	1	1	1	1	*If not available use TS-297/U or TD-352/U
TOOL KIT GENERAL MECHANIC		1	1	1	1	2	
SOLDERING IRON TC-117		1	1	1	1	3	

# APPENDIX III

## BASIC ISSUE ITEMS LIST

---

### Section I. INTRODUCTION

#### I. General

This appendix lists items supplied for initial operation and for running spares. The list includes tools, accessories, parts, and material issued as *part of* the major end item. The list includes all items authorized for basic operator maintenance of the equipment. End items of equipments are issued on the basis of allowances prescribed in equipment authorization tables and other documents that are a basis for requisitioning,

#### 2. Columns

*a. Source, Maintenance, and Recoverability Code.* Not used.

*b. Federal Stock Number.* This column lists the 11-digit Federal stock number. In the absence of a Federal stock number, an interim number, for example ††L8Ra41C-12 in the description column, indicates that a Federal stock number is being processed for assignment. The L number may be used in emergencies to identify items.

*c. Designation by Model.* Not used.

*d. Description.* Nomenclature or the standard item name and brief identifying data for each item are listed in this column. When requisitioning, enter the nomenclature and description,

*e. Unit of Issue.* The unit of issue is the supply term by which the individual item is counted for procurement, storage, requisitioning, allowances, and issue purposes.

*f. Expendability.* Expendable items are indicated by the letter X; nonexpendable items are indicated by NX.

*g. Quantity Authorized.* Under "Items Comprising an Operable Equipment," the column lists the quantity of items supplied for the initial operation of the equipment. Under "Running Spares and Accessory Items," the quantities listed are those issued initially with the equipment as spare parts. The quantities are authorized to be kept on hand by the operator for maintenance of the equipment.

*h. Illustrations.* Not used.

## Section II. FUNCTIONAL PARTS LIST

(a) SOURCE MAINTENANCE AND RECOVERABILITY CODE	(b) FEDERAL STOCK NUMBER	(c) DESIGNATION BY MODEL	(d) DESCRIPTION	(e) UNIT OF ISSUE	(f) EXPENDABILITY	(g) QUANTITY AUTHORIZED	(h) ILLUSTRATIONS	
							FIGURE NO	ITEM NO
ITEMS COMPRISING AN OPERABLE EQUIPMENT								
OPERATIONS CENTRAL AN/MSC-32								
			OPERATIONS CENTRAL AN/MSC-32	ea	NX			
			TECHNICAL MANUAL TM 11-5895-224-15	ea	X	2		
	Ord thru AGC 5815-503-2760		REPERFORATOR, TRANSMITTER, TELETYPEWRITER TY-76/GGC	ea	X	1		
	5410-752-9691		SHELTER, ELECTRICAL EQUIPMENT S-184/MSC-32	ea	NX	1		
	5806-257-3602		SWITCHBOARD, TELEPHONE, MANUAL SB-22/PY: (less cover)	ea	NX	1		
	5805-543-0012		TELEPHONE SET TA-312/PY	ea	NX	4		
	5815-198-4438		TELETYPEWRITER SET TY-4A/YC	ea	NX	2		
	5805-246-8734		TERMINAL, TELEGRAPH TR-5/YC	ea	NX	3		
SHELTER, ELECTRICAL EQUIPMENT S-184/MSC-32								
	4210-727-8111		AXE, PICK HEAD: 2-3/4 lbs; 3-3/4 in lg head; 24 in lg handle; American Logging Tool Co part No. 276	ea	X	1		
	7530-753-8807		BASKET, WASTEPAPER: Eric Art Metal part No. 36	ea	X	3		
	7920-285-9816		BENCH, DUSTING, BENCH: Osborn Mfg part No. 378	ea	X	1		
			CABLE ASSEMBLY, POWER ELECTRICAL: 15 ft lg e/a; 1 conn, plug, elec first end, other end skinned and tinned; St Carl part No. 666147-683    †† L9W94-335	ea	X	1		
	4940-752-2474		CABLE ASSEMBLY, POWER, ELECTRICAL: 15 ft lg; 1 Hubbell type 9756 conn first end, 1 St Carl conduit outlet other end; St Carl part No. 666146-126	ea	X	1		
	5995-481-8440		CABLE ASSEMBLY, TELEPHONE CX-4546/C (250 ft)	ea	X	1		
	5410-752-2435		CABLE ASSEMBLY AND REEL: 22-1/2 in dia x 7-1/2 in w; incl 1 ea Reel, Cable BC-435/U and 1 ea 100 ft power cable; St Carl part No. 666148-414	ea	X	1		
	7105-792-6330		CHAIR, FOLDING: Emco Corp part No. 3501	ea	X	3		
	7110-753-6242		CHAIR, ROTARY, MODIFIED: aluminum; 37-1/4 in h e/a x 15-5/8 in w x 14-1/8 in d; St Carl part No. 666147-877	ea	X	1		
	6645-860-7094		CLOCK, AIRCRAFT, MECHANICAL: 3 in face; Wolman Watch Co part No. 118-12-24-W	ea	NX	1		
	6605-753-8412		COMPASS, MAGNETIC: incl M-19 case; 3-1/8 in lg x 2-13/16 in w x 1-1/4 in thk; Scanlon part N., M-2	ea	X	1		
	7210-753-3043		CUSHION, CHAIR: St Carl part No. 666144-901	ea	X	3		
	6110-649-8146		DISTRIBUTION BOX J-1077A/U	ea	NX	1		

(1) SOURCE MAINTENANCE AND RECOVERABILITY CODE	(2) FEDERAL STOCK NUMBER	(3) DESIGNATION BY MODEL	(4) DESCRIPTION	(5) UNIT OF ISSUE	(6) EXPENDABILITY	(7) QUANTITY AUTHORIZED	(8) ILLUSTRATIONS	
							FIGURE NO	ITEM NO
			AN/MSC-32 (continued)					
	4210-583-7128		EXTINGUISHER, FIRE: Carbon Dioxide; Walter Kidde Model No. 2-1/2 T2	ea	NX	1		
	4210-270-4512		EXTINGUISHER, FIRE: Carbon Dioxide; Walter Kidde Model 5T-2	ea	NX	1		
	5120-408-1481		EXTRACTOR, ELECTRON TUBE: basket type; for 7 pin miniature; Kellems Model No. TP-11-16	ea	X	1		
	5120-293-2692		EXTRACTOR, ELECTRON TUBE: basket type; for 9 pin miniature; Kellems Model No. TP-13-16	ea	X	1		
	6645-752-7902		FAN, VENTILATING, PROPELLER: for exhaust; Rotron Mfg Co type No. KS802L	ea	NX	2		
	4130-765-2361		FILTER: P/o shelter; 19-3/4 in w x 15-3/4 in h x 1-7/8 in thk; Craig part No. 15119P1	ea	X	1		
			FIRST AID KIT: Sig dwg No. SM-C-349935 ++ L9Wa94-90	ea	X	1		
			GRIP, CABLE, JAW: bronze; approx 16 in lg; Economy model No. EQA-6-8P ++ L9Wa94-93	ea	X	13		
			GRIP, CABLE, JAW: bronze; approx 12 in lg; Economy model No. EQA-26S ++ L9Wa94-94	ea	X	12		
	5120-251-4489		HAMMER, HAND: blacksmith double face type; 8 lb; Woodings-Verona Tool Works part No. 15	ea	X	1		
	4520-224-7909		HEATER, SPACE, ELECTRIC: 115 v ac; 12-1/2 in lg x 10-3/4 in h x 10-1/8 in w; Electromode part No. AAT-15A	ea	NX	2		
	5830-752-5357		INTERCOMMUNICATION STATION LS-147C/FI	ea	NX	1		
	5120-224-2510		KEY, SOCKET, HEADSCREW: for drain plug; 6-3/4 in lg o/a; Standard Pressed Steel model Unbrako 5/8	ea	X	1		
	5410-783-6680		LADDER: aluminum; 64-5/8 in h x 18-1/2 in w x 6-1/2 in d; St Carl part No. 666149-684	ea	X	1		
	6230-729-9614		LANTERN, ELECTRIC: mtd on wall; Justrite part No. 2106-7	ea	X	1		
			LEAD, ELECTRICAL: used for grounding; 1-1/2 in w x 122 in lg o/a; St Carl part No. 666147-692 ++ L9Wa94-261	ea	X	2		
	6230-752-2479		LIGHT, EXTENSION: molded rubber handle w/25 ft cord; GE type No. 107-5	ea	X	1		
	6625-498-3677		MULTIMETER TS-297/U	ea	NX	1		
	5120-392-8355		PIN, STRAIGHTENER, ELECTRON TUBE: Tenite body; 2 steel inserts; 2-7/8 in lg x 1-1/8 in w x 1-5/16 in h; General Comat Mfg model No. 8655	ea	X	1		
	8130-656-1090		REEL, CABLE RC-435/U: Sig dwg No. SC-DL-69296	ea	X	1		
	5975-640-3662		ROD, GROUND: steel; 5 ft lg x 5/8 in dia; Hubbard part No. 2665	ea	X	2		
	5120-755-9675		SCREWDRIVER, FLAT TIP: plastic handle, rubber insulated; 10-1/4 in lg; 5/16 in w tip; Bridgeport Hnd Mfr Corp part No. 2143-6	ea	X	1		
			SHARPENER, PENCIL: Boston type-L ++ L9Wa94-105	ea	X	1		
	6210-754-8134		SHIELD, LIGHT: for fluorescent; styrene; St Carl part No. 666147-309	ea	X	8		
	5410-805-5533		SLING, MULTIPLE LEG: for shelter lifting and tie-down; Craig part No. 14804G1	ea	X	1		

AN/MSC-32

(a)			(b)			(c)			(d)			(e)		(f)		(g)	
SOURCE MAINTENANCE AND RECOVERABILITY CODE	FEDERAL STOCK NUMBER	DESIGNATION BY MODEL	DESCRIPTION						UNIT OF ISSUE	EXPENDABILITY	QUANTITY AUTHORIZED	ILLUSTRATIONS					
												FIGURE NO	ITEM NO				
			AN/MSC-32 (continued)														
			STRAP ASSEMBLY, TIE DOWN: nylon webbing and steel: 72-5/8 in lg x 2-7/8 in w; Craig part No. P/N-705      †† L9W94-245						ea	X	12						
			RUNNING SPARES AND ACCESSORY ITEMS														
			OPERATIONS CENTRAL AN/MSC-32														
	5120-793-2027		HANDLE, HAMMER: hickory; Wooding-Verona Tool Works part No. AV-30						ea	X	1						
	6240-538-8447		LAMP, FLUORESCENT: 20 w; 24 in lg; Sylvania part No. F20F12/SW						ea	X	2						
	6240-299-5876		LAMP, GLOW: MIL type NE-34						ea	X	1						
	6240-179-1814		LAMP, GLOW: MIL type NE-45						ea	X	2						
	6240-143-3070		LAMP, INCANDESCENT: 50 w; GE part No. 50A/RS						ea	X	1						
	6240-155-7786		LAMP, INCANDESCENT: for lantern; 2.4 v; GE part No. PR-2 (mtd in lantern)						ea	X	1						
	5410-783-6250		REPAIR KIT, ELECTRICAL EQUIPMENT, SHELTER: to repair punctures to shelter skin; DeLorme Ind part No. 711						ea	X	1						
	6250-299-2884		STARTER, FLUORESCENT LAMP: Bryant Elec part No. FS-2						ea	X	6						

AN/MSC-32



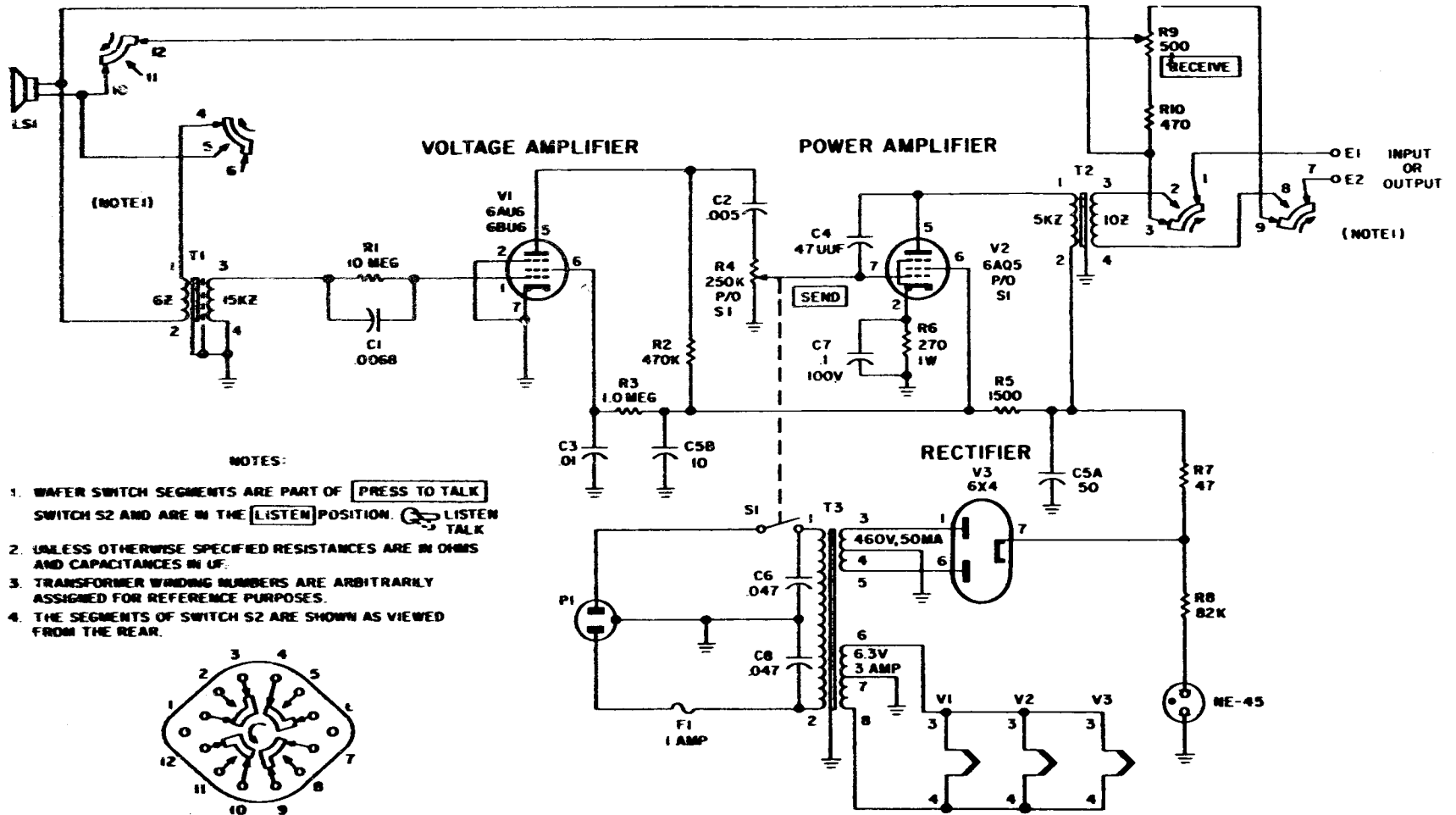

- NOTES:
1. WAFER SWITCH SEGMENTS ARE PART OF **PRESS TO TALK** SWITCH S2 AND ARE IN THE **LISTEN** POSITION. LISTEN TALK
  2. UNLESS OTHERWISE SPECIFIED RESISTANCES ARE IN OHMS AND CAPACITANCES IN UF.
  3. TRANSFORMER WINDING NUMBERS ARE ARBITRARILY ASSIGNED FOR REFERENCE PURPOSES.
  4. THE SEGMENTS OF SWITCH S2 ARE SHOWN AS VIEWED FROM THE REAR.

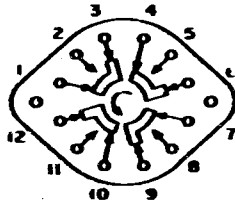
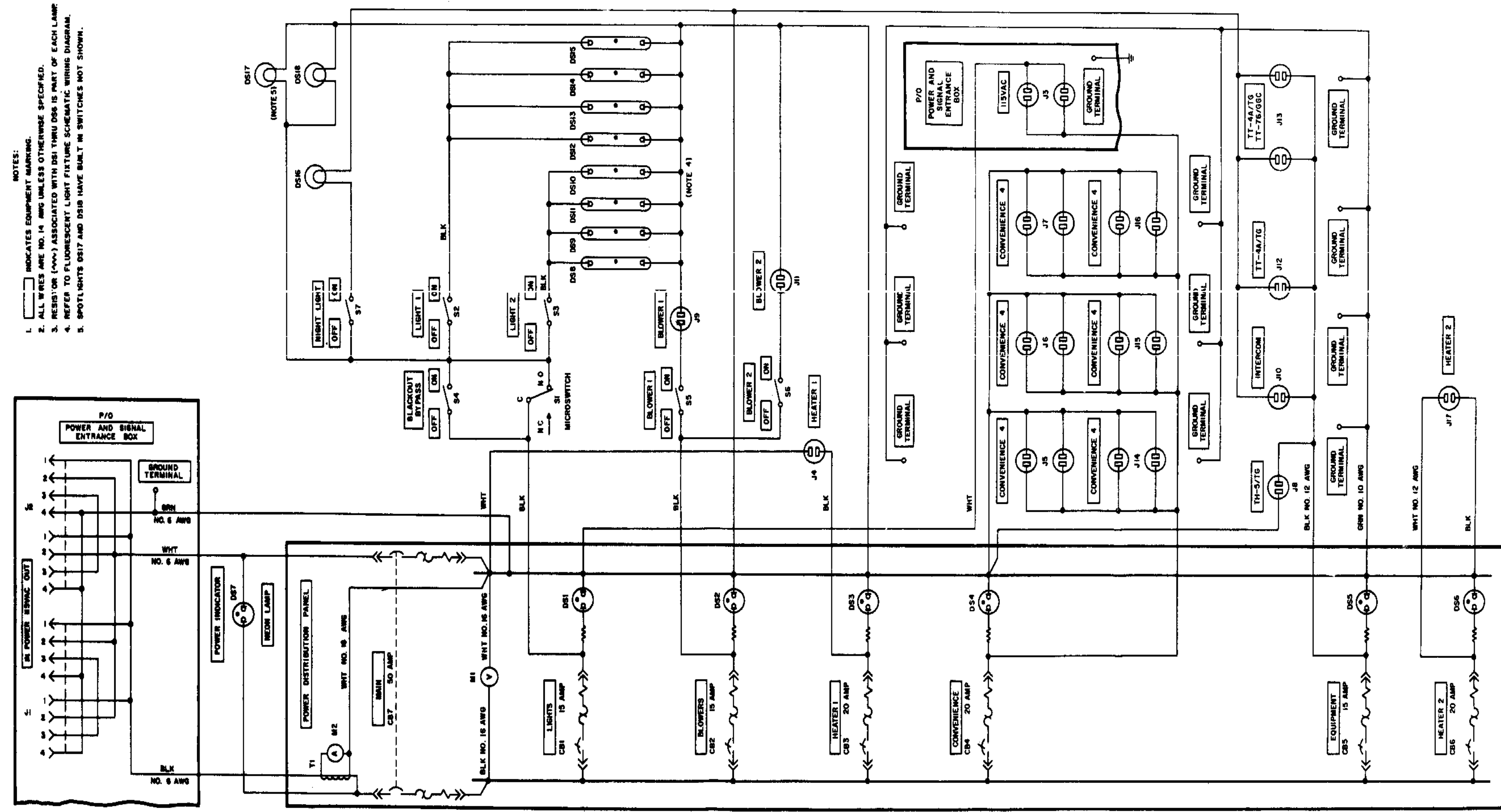
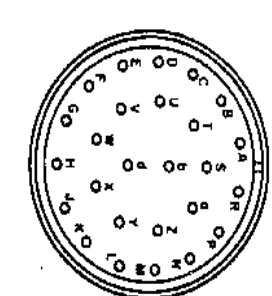
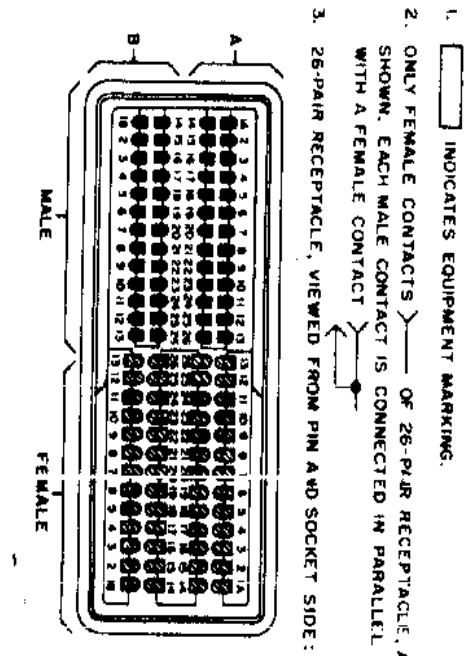
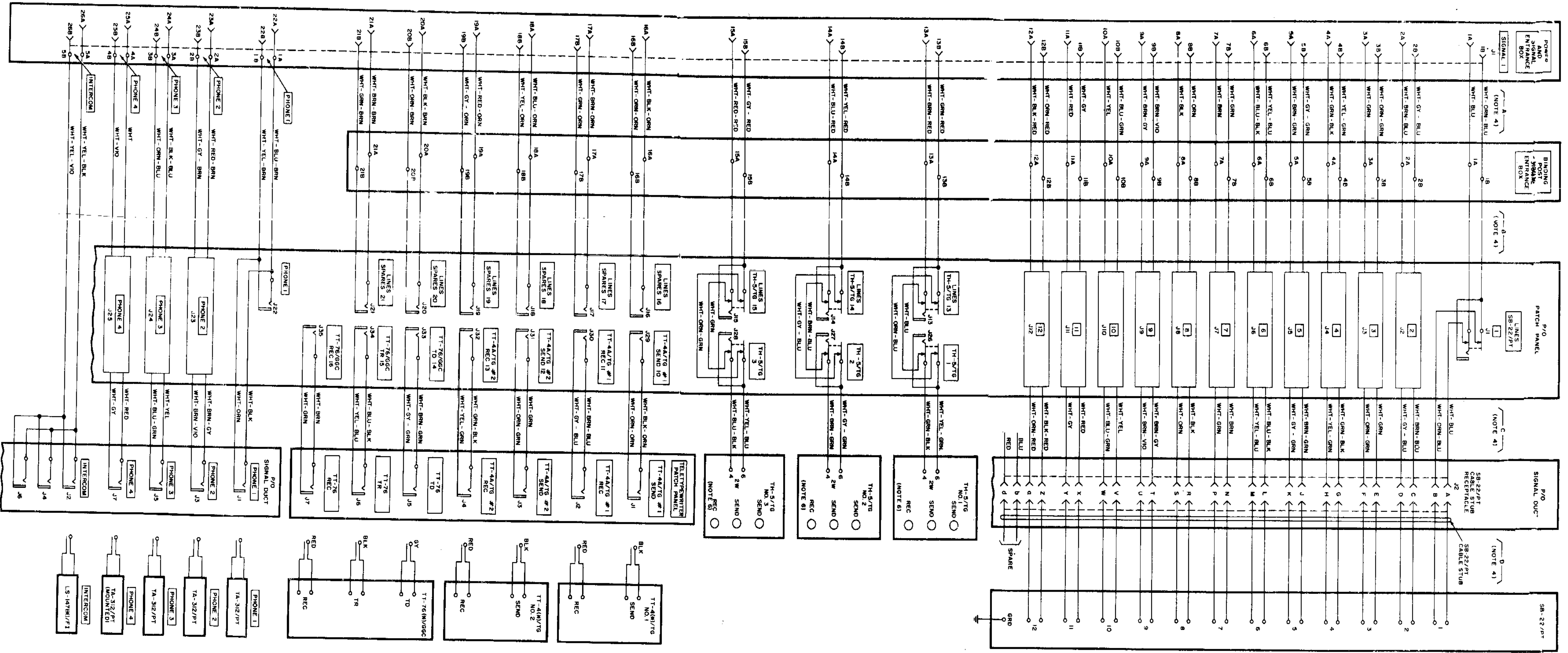

Figure 40. Intercommunication Station LS-147C/F1, schematic diagram.



- NOTES:
1. [Symbol] INDICATES EQUIPMENT MARKING.
  2. ALL WIRES ARE NO. 14 AWG UNLESS OTHERWISE SPECIFIED.
  3. RESISTOR (R) ASSOCIATED WITH DS1 THRU DS6 IS PART OF EACH LAMP.
  4. REFER TO FLUORESCENT LIGHT FIXTURE SCHEMATIC WIRING DIAGRAM.
  5. SPOTLIGHTS DS17 AND DS18 HAVE BUILT IN SWITCHES NOT SHOWN.

Figure 41. Operations Central AN/MSC-38, power schematic-wiring diagram.



1. INDICATES EQUIPMENT MARKING.
2. ONLY FEMALE CONTACTS OF 26-PIN RECEPTACLE ARE SHOWN. EACH MALE CONTACT IS CONNECTED IN PARALLEL WITH A FEMALE CONTACT .
3. 26-PIN RECEPTACLE, VIEWED FROM PIN AND SOCKET SIDE:
4. COLOR CODE IN B IS THE SAME AS SHOWN IN A, AND COLOR CODE IN D IS THE SAME AS SHOWN IN C.
5. ALL WIRES ARE NO. 16 AWG UNLESS OTHERWISE SPECIFIED.
6. TH-5/TG TERMINALS D2 AND F2 INTERNALLY STAPLED.
7. SB-22/P7 CABLE STUB CONNECTOR, VIEWED FROM SOCKET SIDE.

TM9895-224-15-21

Figure 42. Operations Central AN/MSC-32, signal schematic-wiring diagram.

# INDEX

	Paragraph	Page		Paragraph	Page
<b>Ac circuits:</b>			<b>S-184/MSC-32</b> .....	7a	6-8
<b>Connecting</b> .....	21	30, 31	<b>Switchboard, Telephone, Manual</b>		
<b>Description</b> .....	7a	6-8	<b>SB-22(*)/PT</b> .....	7b	8
<b>Energizing</b> .....	26	35	<b>Telephone Set TA-812/PT</b> .....	7c	8
<b>Grounding</b> .....	20	30	<b>Teletypewriter TT-4(*)/TG</b> .....	7e	8
<b>Lighting</b> .....	7a	6-8	<b>Terminal Box TA-125/GT</b> .....	7g	8
<b>Stopping</b> .....	29	37,38	<b>Terminal, Telegraph TH-5/G</b> .....	7d	8
<b>Theory</b> .....	56	54, 55	<b>Disassembly of equipment</b> .....	52	50,51
<b>Troubleshooting</b> .....	46,47	44,45	<b>Door microswitch, replacement</b> .....	45b	44
<b>Authority for demolition</b> .....	59	57	<b>Electric heater:</b>		
<b>Cables:</b>			<b>Controls</b> .....	25d	34
<b>Connection</b> .....	21-23	30-32	<b>Description</b> .....	8a	10
<b>Description</b> .....	8i	12,13	<b>Operation</b> .....	27a	36
<b>Characteristics, AN/MSC-32 technical</b>	4	4	<b>Repair</b> .....	49	47,48
<b>Chart, troubleshooting references</b> .....	47	44,45	<b>Stopping procedures</b> .....	29b	37,38
<b>Checking equipment</b> .....	10	20	<b>Energizing ac circuit</b> .....	26	35
<b>Checklist, equipment performance</b> .....	35	40,41	<b>Equipment performance checklist</b> .....	35	40,41
<b>Circuit breaker switches:</b>			<b>Exhaust blowers:</b>		
<b>Description</b> .....	25a	33	<b>Controls</b> .....	25c	34
<b>Operation</b> .....	26	35	<b>Cover removal</b> .....	39	48
<b>Replacement</b> .....	48b	45	<b>Description</b> .....	8c	10
<b>Circuit connections</b> .....	22	31	<b>Operation</b> .....	27b	36
<b>Cold climates, operation</b> .....	28a	37	<b>Repair</b> .....	50	49,50
<b>Comments on manual</b> .....	2	3	<b>Stopping</b> .....	29b	37,38
<b>Components:</b>			<b>Fluorescent light fixture repair</b> .....	52	51,52
<b>Connections</b> .....	11-16	20-25	<b>Forms and records:</b>		
<b>Description</b> .....	7,8	6-19	<b>Comments on manual</b> .....	2e	3
<b>Installation of major components</b> .....	11-16	20-25	<b>Preventive maintenance forms</b> .....	2c	3
<b>Installation testing</b> .....	17	25-27	<b>Report of damaged or improper</b>		
<b>List</b> .....	5	5,6	<b>shipment</b> .....	2b	3
<b>Power consumption</b> .....	4	4	<b>Unsatisfactory equipment report</b> ..	2a	8
<b>Connections:</b>			<b>General maintenance</b> .....	30	39
<b>Grounding</b> .....	20	30	<b>Grounding</b> .....	20	30
<b>Power</b> .....	21	30,31	<b>Hot climates, operation</b> .....	28b	37
<b>26-pair cable</b> .....	22, 23	31,32	<b>Installation:</b>		
<b>Controls, shelter components</b> .....	25	33-35	<b>AN/MSC-32</b> .....	15	24-25
<b>Daily preventive maintenance</b> .....	32	39,40	<b>Distribution Box J-1077A/U</b> .....		25
<b>Demolition</b> .....	59,60	57	<b>General</b> .....	9	20
<b>Description:</b>			<b>Reperforator-Transmitter, Teletype-</b>		
<b>AN/MSC-32</b> .....	6	6	<b>writer TT-76(*)/GGC</b> .....	14	24
<b>Clock</b> .....	8e	10	<b>Switchboard, Telephone, Manual</b>	11	20-23
<b>Cords and cables</b> .....	8i	12,18	<b>SB-22(*)/PT</b> .....		
<b>Distribution Box J-1077A/U</b> .....	8d	10	<b>Telephone Set TA-812/PT</b> .....	12	23-24
<b>Electric heater</b> .....	8a	10	<b>Teletypewriter TT-4(*)/TG</b> .....	15	24,25
<b>Exhaust blowers</b> .....	8c	10	<b>Terminal Box TA-125/GT</b> .....	16a	25
<b>Intercommunication Station</b>			<b>Terminal Telegraph TH-5/TG</b> .....	13	24
<b>LS-147(*)/FI</b> .....	8b	10	<b>Testing</b> .....	17	25-27
<b>Lighting</b> .....	7a	6-8	<b>Uncrating</b> .....	10	20
<b>Power and signal entrance box</b> .....	7a	6-8	<b>Lamps, replacement</b> .....	37	42,43
<b>Power distribution panel</b> .....	7a	6-8	<b>Lantern, hand, repairs</b> .....	36	42
<b>Reperforator-Transmitter, Teletype-</b>					
<b>writer TT-76(*)/GGC</b> .....	7f	8			
<b>Shelter, Electrical Equipment,</b>					

	Paragraph	Page		Paragraph	Page
Lighting:					
Controls -----	25b	33,34	Fluorescent light fixture parts -----	37,50	
Description -----	7a	6-8	Hand lantern parts -----	36	
Operation -----	26	35	Intercommunication Station		
Loading AN/MSG-32 -----	19	27-30	LS-147(*)/FI -----	40	43
Lubrication -----	34	40	Lamps -----	37	42,43
Maintenance:			Power distribution panel parts ---	48	45-47
Daily preventive	32	39,40	Reperforator-Transmitter, Teletype-		
Equipment performance checklist --	35	40,41	writer TT-76(*)/GGC -----	44	44
Forms and records -----	2c	3	Switchboard, Telephone, Manuel		
General -----	30	39	SB-22(*)/PT -----	38	43
Lubrication -----	34	40	Switches -----	51	50
Monthly preventive -----	34	40	Telephone Set TA-312/PT -----	42	43
Running spares -----Appx	III	68-72	Teletypewriter TT-4(*)\TG -----	43	44
Tools and materials -----	31	39	Terminal, Telegraph TH-5/G ----	45	44
Troubleshooting instructions -----	46,47	44, 45	Repair:		
Weekly preventive -----	33	40	Electric heater -----	9	47,48
Manual:			Exhaust blower -----	50	49,50
Comments -----	2e	3	Fluorescent lamp fixtures -----	52	50, 51
Scope -----	I	3	Power distribution panel -----	48	45-47
Materials, maintenance -----	31b	39	Shelter, Electrical Equipment		
Meters, replacement -----	48b	46,47	S-184/MSG-32 -----	54	52,53
Microswitch, replacement -----	51b	50	Switches -----	51	50
Monthly preventive maintenance ----	34	40	26-pair cable receptacle -----	53	51,52
Neon lamps, removal and replacement -	37c	43	Running spares -----	5b	5,6
Operation:			Scope -----	1	3
Energizing ac circuits -----	26	35	Securing AN/MSG-32 to truck -----	19b	29
Patching -----	27h	37	Shelter, Electrical Equipment		
Procedures -----	27	36,37	S-184/MSG-32:		
Stopping -----	29	37,38	Circuit connections -----	22	
Under adverse climatic conditions -	28	37	Components -----	5b	
Patching procedure -----	27h	37	Controls and instruments -----	25	33-35
Power:			Description -----	7a	6-8
Cables, description -----	8i	12, 13	Destruction -----	59,60	57
Circuits, theory -----	56	54,55	Disassembly of equipment -----	57	56
Connections -----	21	30,31	Installation -----	19	27-30
Consumption -----	4	4	Operating procedures -----	27	36,37
Power and signal entrance box:			Operator's maintenance -----	3-45	39,44
Connections -----	22,23	31,32	Repair -----	54	52,53
Description -----	7a	6-8	Securing to truck -----	19	27-30
Power distribution panel:			Siting -----	18	27
Controls and instruments -----	25a	33	Stopping procedures -----	29	37,38
Description -----	7a	6-8	Storage -----	57	56
Operation -----	26	35	Transportation -----	58	56
Repairs -----	48	45-47	Uncrating -----	10	20
Power duct switch, replacement -----	51a	50	Signal circuits:		
Purpose and use -----	3	3	Connections -----	22	31
Records and forms:			Testing -----	17	25-27
Comments on manual -----	2e	3	Theory -----	55	54
Preventive maintenance forms -----	2c	3	Siting -----	18	27
Report of damaged or improper			Stopping procedures -----	29	37,38
shipment -----	2b	3	Storage -----	57	56
Unsatisfactory equipment report --	2a	3	Switchboard, Telephone, Manuel		
Removal and Replacement:			SB-22(*)/PT:		
Electric heater and parts -----	38,39	43,47,48	Description -----	7b	8
Exhaust blower and parts -----	39,50	43,49,50	Installation and connection -----	11	20-23
			Removal and replacement -----	41	43
			Switches:		
			Controls and instruments -----	25	33-35
			Removal and replacement -----	51	

	Paragraph	Page		Paragraph	Page
Technical characteristics of			Connections -----	27d	36
AN/MSC-32 -----	4	4	Controls -----	25i	35
Telephone Set TA-312/PT:			Description -----	8h	12
Description -----	7c	8	Operation -----	27d	36
Installation and connection -----	12	23,24	Theory:		
Removal and replacement -----	42	43	Ac power -----	56	54, 55
Testing, installation -----	17	25-27	Signal circuits -----	55	55
TH-5/TG subdistribution panel:			Tools and test equipment -----	Appx II	62, 67

By Order of the Secretary of the Army:

G. H. DECKER,  
General, United States Army,  
Chief of Staff.

Official:

R. V. LEE,  
Major General, United States Army,  
The Adjutant General.

Distribution:

*Active Army:*

To be distributed in accordance with DA Form 12-7 requirements for TM 11 Series (UNCLAS) plus the following formula:

USASA (2)	11-16
CNGB (1)	11-57
Tech Stf, DA (1) except	11-86
CSigO (18)	11-87
DASA (5)	11-97
ARADCOM (2)	11-117
ARADCOM Rgn (2)	11-155
MDW (1)	11-500 (AA-AE) (4)
Seventh US Army (2)	11-557
EUSA (2)	11-587
Units org under fol TOE:	11-592
(2 copies each UNOINDC)	11-597
11-7	33-105
11-15	33-106

*NG:* State AG (3); Units—Same as Active Army except allowance is one copy for each unit.

*USAR:* None.

For explanation of abbreviations used, see AR 320-50.

☆ U.S. GOVERNMENT PRINTING OFFICE : 1988 O - 201-421 (71322)

RECOMMENDED CHANGES TO EQUIPMENT TECHNICAL PUBLICATIONS



THEN...JOT DOWN THE  
DOPE ABOUT IT ON THIS FORM.  
CAREFULLY TEAR IT OUT, FOLD IT  
AND DROP IT IN THE MAIL.

SOMETHING WRONG WITH PUBLICATION

FROM: (PRINT YOUR UNIT'S COMPLETE ADDRESS)

DATE SENT

PUBLICATION NUMBER

PUBLICATION DATE

PUBLICATION TITLE

BE EXACT PIN-POINT WHERE IT IS

PAGE  
NO.

PARA-  
GRAPH

FIGURE  
NO.

TABLE  
NO.

IN THIS SPACE, TELL WHAT IS WRONG  
AND WHAT SHOULD BE DONE ABOUT IT.

TEAR ALONG PERFORATED LINE

PRINTED NAME, GRADE OR TITLE AND TELEPHONE NUMBER

SIGN HERE



# The Metric System and Equivalents

## Linear Measure

1 centimeter = 10 millimeters = .39 inch  
 1 decimeter = 10 centimeters = 3.94 inches  
 1 meter = 10 decimeters = 39.37 inches  
 1 dekameter = 10 meters = 32.8 feet  
 1 hectometer = 10 dekameters = 328.08 feet  
 1 kilometer = 10 hectometers = 3,280.8 feet

## Weights

1 centigram = 10 milligrams = .15 grain  
 1 decigram = 10 centigrams = 1.54 grains  
 1 gram = 10 decigrams = .035 ounce  
 1 dekagram = 10 grams = .35 ounce  
 1 hectogram = 10 dekagrams = 3.52 ounces  
 1 kilogram = 10 hectograms = 2.2 pounds  
 1 quintal = 100 kilograms = 220.46 pounds  
 1 metric ton = 10 quintals = 1.1 short tons

## Liquid Measure

1 centiliter = 10 milliliters = .34 fl. ounce  
 1 deciliter = 10 centiliters = 3.38 fl. ounces  
 1 liter = 10 deciliters = 33.81 fl. ounces  
 1 dekaliter = 10 liters = 2.64 gallons  
 1 hectoliter = 10 dekaliters = 26.42 gallons  
 1 kiloliter = 10 hectoliters = 264.18 gallons

## Square Measure

1 sq. centimeter = 100 sq. millimeters = .155 sq. inch  
 1 sq. decimeter = 100 sq. centimeters = 15.5 sq. inches  
 1 sq. meter (centare) = 100 sq. decimeters = 10.76 sq. feet  
 1 sq. dekameter (are) = 100 sq. meters = 1,076.4 sq. feet  
 1 sq. hectometer (hectare) = 100 sq. dekameters = 2.47 acres  
 1 sq. kilometer = 100 sq. hectometers = .386 sq. mile

## Cubic Measure

1 cu. centimeter = 1000 cu. millimeters = .06 cu. inch  
 1 cu. decimeter = 1000 cu. centimeters = 61.02 cu. inches  
 1 cu. meter = 1000 cu. decimeters = 35.31 cu. feet

## Approximate Conversion Factors

To change	To	Multiply by	To change	To	Multiply by
inches	centimeters	2.540	ounce-inches	newton-meters	.007062
feet	meters	.305	centimeters	inches	.394
yards	meters	.914	meters	feet	3.280
miles	kilometers	1.609	meters	yards	1.094
square inches	square centimeters	6.451	kilometers	miles	.621
square feet	square meters	.093	square centimeters	square inches	.155
square yards	square meters	.836	square meters	square feet	10.764
square miles	square kilometers	2.590	square meters	square yards	1.196
acres	square hectometers	.405	square kilometers	square miles	.386
cubic feet	cubic meters	.028	square hectometers	acres	2.471
cubic yards	cubic meters	.765	cubic meters	cubic feet	35.315
fluid ounces	milliliters	29.573	cubic meters	cubic yards	1.308
pints	liters	.473	milliliters	fluid ounces	.034
quarts	liters	.946	liters	pints	2.113
gallons	liters	3.785	liters	quarts	1.057
ounces	grams	28.349	liters	gallons	.264
pounds	kilograms	.454	grams	ounces	.035
short tons	metric tons	.907	kilograms	pounds	2.205
pound-feet	newton-meters	1.356	metric tons	short tons	1.102
pound-inches	newton-meters	.11296			

## Temperature (Exact)

°F	Fahrenheit	5/9 (after	Celsius	°C
	temperature	subtracting 32)	temperature	

